

---

## Caution

---



Do not exceed the operating input power, voltage, and current level and signal type appropriate for the instrument being used, refer to your instrument's Function Reference.



Electrostatic discharge(ESD) can damage the highly sensitive microcircuits in your instrument. ESD damage is most likely to occur as the test fixtures are being connected or disconnected. Protect them from ESD damage by wearing a grounding strap that provides a high resistance path to ground. Alternatively, ground yourself to discharge any static charge built-up by touching the outer shell of any grounded instrument chassis before touching the test port connectors.

---

## **Safety Summary**

---

When you notice any of the unusual conditions listed below, immediately terminate operation and disconnect the power cable.

Contact your local Agilent Technologies sales representative or authorized service company for repair of the instrument. If you continue to operate without repairing the instrument, there is a potential fire or shock hazard for the operator.

- Instrument operates abnormally.
- Instrument emits abnormal noise, smell, smoke or a spark-like light during operation.
- Instrument generates high temperature or electrical shock during operation.
- Power cable, plug, or receptacle on instrument is damaged.
- Foreign substance or liquid has fallen into the instrument.

---

## **Herstellerbescheinigung**

### GERÄUSCHEMISSION

LpA < 70 dB  
am Arbeitsplatz  
normaler Betrieb  
nach DIN 45635 T. 19

---

## **Manufacturer's Declaration**

### ACOUSTIC NOISE EMISSION

LpA < 70 dB  
operator position  
normal operation  
per ISO 7779

## **Regulatory compliance information**

This product complies with the essential requirements of the following applicable European Directives, and carries the CE marking accordingly:

The Low Voltage Directive 73/23/EEC, amended by 93/68/EEC

The EMC Directive 89/336/EEC, amended by 93/68/EEC

To obtain Declaration of Conformity, please contact your local Agilent Technologies sales office, agent or distributor.

---

---

## Safety notice supplement

---

---

- This equipment complies with EN/IEC61010-1:2001.
- This equipment is MEASUREMENT CATEGORY I (CAT I). Do not use for CAT II, III, or IV.
- Do not connect the measuring terminals to mains.
- This equipment is POLLUTION DEGREE 2, INDOOR USE product.
- This equipment is tested with stand-alone condition or with the combination with the accessories supplied by Agilent Technologies against the requirement of the standards described in the Declaration of Conformity. If it is used as a system component, compliance of related regulations and safety requirements are to be confirmed by the builder of the system.



**Agilent E5061A/E5062A  
ENA Series RF Network Analyzers**

# **User's Guide**

**Second Edition**

**FIRMWARE REVISIONS**

This manual applies directly to instruments that have the firmware revision A.02.00.  
For additional information about firmware revisions, see Appendix A.



**Agilent Part No. E5061-90010**

**September 2005**

---

## Notices

The information contained in this document is subject to change without notice.

This document contains proprietary information that is protected by copyright. All rights are reserved. No part of this document may be photocopied, reproduced, or translated to another language without the prior written consent of Agilent Technologies.

Microsoft®, MS-DOS®, Windows®, Visual C++®, Visual Basic®, VBA® and Excel® are registered

UNIX is a registered trademark in U.S. and other countries, licensed exclusively through X/Open Company Limited.

Portions ©Copyright 1996, Microsoft Corporation. All rights reserved.

© Copyright 2004, 2005 Agilent Technologies

---

## Manual Printing History

The manual's printing date and part number indicate its current edition. The printing date changes when a new edition is printed (minor corrections and updates that are incorporated at reprint do not cause the date to change). The manual part number changes when extensive technical changes are incorporated.

February 2004      First Edition (part number: E5061-90000)

September 2005      Second Edition (part number: E5061-90010, changes for firmware version A.02.00)



---

## Safety Summary

The following general safety precautions must be observed during all phases of operation, service, and repair of this instrument. Failure to comply with these precautions or with specific WARNINGS elsewhere in this manual may impair the protection provided by the equipment. Such noncompliance would also violate safety standards of design, manufacture, and intended use of the instrument. Agilent Technologies assumes no liability for the customer's failure to comply with these precautions.

---

**NOTE** The E5061A/E5062A complies with INSTALLATION CATEGORY II as well as POLLUTION DEGREE 2 in IEC61010-1. The E5061A/E5062A is an INDOOR USE product.

---

---

**NOTE** The LEDs in the E5061A/E5062A are Class 1 in accordance with IEC60825-1, CLASS 1 LED PRODUCT

---

---

**NOTE** This equipment is MEASUREMENT CATEGORY I (CAT I). Do not use for CAT II, III, or IV.

---

---

**NOTE** This equipment is tested with stand-alone condition or with the combination with the accessories supplied by Agilent Technologies against the requirement of the standards described in the Declaration of Conformity. If it is used as a system component, compliance of related regulations and safety requirements are to be confirmed by the builder of the system.

---

- **Ground the Instrument**  
To avoid electric shock, the instrument chassis and cabinet must be grounded with the supplied power cable's grounding prong.
- **DO NOT Operate in an Explosive Atmosphere**  
Do not operate the instrument in the presence of inflammable gasses or fumes. Operation of any electrical instrument in such an environment clearly constitutes a safety hazard.
- **Keep Away from Live Circuits**  
Operators must not remove instrument covers. Component replacement and internal adjustments must be made by qualified maintenance personnel. Do not replace components with the power cable connected. Under certain conditions, dangerous voltage levels may remain even after the power cable has been disconnected. To avoid injuries, always disconnect the power and discharge circuits before touching them.
- **DO NOT Service or Adjust the Instrument Alone**  
Do not attempt internal service or adjustment unless another person, capable of rendering first aid and resuscitation, is present.
- **DO NOT Substitute Parts or Modify the Instrument**  
To avoid the danger of introducing additional hazards, do not install substitute parts or perform unauthorized modifications to the instrument. Return the instrument to an

Agilent Technologies Sales and Service Office for service and repair to ensure that safety features are maintained in operational condition.

- Dangerous Procedure Warnings

Warnings, such as the example below, precede potentially dangerous procedures throughout this manual. Instructions contained in the warnings must be followed.

---

**WARNING**

---

**Dangerous voltage levels, capable of causing death, are present in this instrument. Use extreme caution when handling, testing, and adjusting this instrument.**

- Do not connect the measuring terminals to mains.

---

## Safety Symbols

General definitions of safety symbols used on the instrument or in manuals are listed below.



Instruction Manual symbol: the product is marked with this symbol when it is necessary for the user to refer to the instrument manual.



Alternating current.



Direct current.



On (Supply).



Off (Supply).



In-position of push-button switch.



Out-position of push-button switch.



A chassis terminal; a connection to the instrument's chassis, which includes all exposed metal structure.



Stand-by.

---

**WARNING**

---

**This warning sign denotes a hazard. It calls attention to a procedure, practice, or condition that, if not correctly performed or adhered to, could result in injury or death to personnel.**

---

**CAUTION**

---

This Caution sign denotes a hazard. It calls attention to a procedure, practice, or condition that, if not correctly performed or adhered to, could result in damage to or destruction of part or all of the instrument.

---

**NOTE**

---

This Note sign denotes important information. It calls attention to a procedure, practice, or condition that is essential for the user to understand.

---

## **Certification**

Agilent Technologies certifies that this product met its published specifications at the time of shipment from the factory. Agilent Technologies further certifies that its calibration measurements are traceable to the United States National Institute of Standards and Technology, to the extent allowed by the Institution's calibration facility or by the calibration facilities of other International Standards Organization members.

---

## **Documentation Warranty**

The material contained in this document is provided "as is," and is subject to being changed, without notice, in future editions. Further, to the maximum extent permitted by applicable law, Agilent disclaims all warranties, either express or implied with regard to this manual and any information contained herein, including but not limited to the implied warranties of merchantability and fitness for a particular purpose. Agilent shall not be liable for errors or for incidental or consequential damages in connection with the furnishing, use, or performance of this document or any information contained herein. Should Agilent and the user have a separate written agreement with warranty terms covering the material in this document that conflict with these terms, the warranty terms in the separate agreement will control.

---

## **Exclusive Remedies**

The remedies provided herein are Buyer's sole and exclusive remedies. Agilent Technologies shall not be liable for any direct, indirect, special, incidental, or consequential damages, whether based on contract, tort, or any other legal theory.

---

## **Assistance**

Product maintenance agreements and other customer assistance agreements are available for Agilent Technologies products.

For any assistance, contact your nearest Agilent Technologies Sales and Service Office. Addresses are provided at the back of this manual.

---

## Typeface Conventions

**Sample (bold)**

Boldface type is used when a term is defined or emphasis.

*Sample (Italic)*

Italic type is used for emphasis.

Sample key

Indicates a hardkey (key on the front panel or external keyboard) labeled "Sample." "key" may be omitted.

**Sample** menu/button/box

Indicates a menu/button/box on the screen labeled "Sample" which can be selected/executed by clicking. "menu," "button," or "box" may be omitted.

**Sample** block/toolbar

Indicates a block (group of hardkeys) or a toolbar (setup toolbar) labeled "Sample."

**Sample 1 - Sample 2 - Sample 3**

Indicates a sequential operation of **Sample 1**, **Sample 2**, and **Sample 3** (menu, button, or box). "-" may be omitted.

---

## Documentation Map

The following manuals are available for the Agilent E5061A/E5062A.

- ***User's Guide (Part Number E5061-900x0, attached to Option ABA)***

This manual describes most of the basic information needed to use the E5061A/E5062A. It provides a function overview, detailed operation procedure for each function (from preparation for measurement to analysis of measurement results), measurement examples, specifications, and supplemental information. For programming guidance on performing automatic measurement with the E5061A/E5062A, please see the *Programming Manual*.
- ***Installation and Quick Start Guide (Part Number E5061-900x1, attached to Option ABA)***

This manual describes installation of the instrument after it is delivered and the basic procedures for applications and analysis. Refer to this manual when you use the E5061A/E5062A for the first time.
- ***Programmer's Guide (Part Number E5061-900x2, attached to Option ABA)***

This manual provides programming information for performing automatic measurement with the E5061A/E5062A. It includes an outline of remote control, procedures for detecting measurement start (trigger) and end (sweep end), application programming examples, a command reference, and related information.
- ***VBA Programmer's Guide (Part Number E5061-900x3, attached to Option ABA)***

This manual describes programming information for performing automatic measurement with internal controller. It includes an outline of VBA programming, some sample programming examples, a COM object reference, and related information.
- ***Option 100 Fault Location and Structural Return Loss Measurement User's Guide Supplement (Part Number E5061-900x4, attached to Option 100)***

This manual describes information for using the fault location and structural return loss measurement functions.

---

### NOTE

The number position shown by "x" in the part numbers above indicates the edition number. This convention is applied to each manual, CD-ROM (for manuals), and sample programs disk issued.

---

---

## **VBA Macro**

The Agilent folder (D:\Agilent) on the hard disk of the E5061A/E5062A contains the VBA macros (VBA Projects) used in this manual.

The customer shall have the personal, non-transferable rights to use, copy, or modify the VBA macros for the customer's internal operations.

The customer shall use the VBA macros solely and exclusively for their own purposes and shall not license, lease, market, or distribute the VBA macros or modification of any part thereof.

Agilent Technologies shall not be liable for any infringement of any patent, trademark, copyright, or other proprietary right by the VBA macros or their use. Agilent Technologies does not warrant that the VBA macros are free from infringements of such rights of third parties. However, Agilent Technologies will not knowingly infringe or deliver software that infringes the patent, trademark, copyright, or other proprietary right of a third party.

|  |    |
|--|----|
| <b>1. Precautions</b>  |    |
| Software Installed . . . . .                                       | 18 |
| <b>2. Overview of Functions</b>                                    |    |
| Front Panel: Names and Functions of Parts . . . . .                | 20 |
| 1. Standby Switch . . . . .  | 21 |
| 2. LCD Screen . . . . .  | 21 |
| 3. ACTIVE CH/TRACE Block . . . . .                                 | 22 |
| 4. RESPONSE Block . . . . .  | 23 |
| 5. STIMULUS Block . . . . .  | 24 |
| 6. Floppy Disk Drive . . . . .                                     | 24 |
| 7. NAVIGATION Block . . . . .                                      | 25 |
| 8. ENTRY Block . . . . .   | 26 |
| 9. INSTR STATE Block . . . . .                                     | 27 |
| 10. MKR/ANALYSIS Block . . . . .                                   | 28 |
| ⚠ 11. Test Port . . . . .  | 28 |
| 12. Front USB Port . . . . .                                       | 29 |
| 13. Ground Terminal . . . . .                                      | 29 |
| Screen Area: Names and Functions of Parts . . . . .                | 30 |
| 1. Menu Bar . . . . .  | 30 |
| 2. Data Entry Bar . . . . .  | 30 |
| 3. Softkey Menu Bar . . . . .                                      | 32 |
| 4. Instrument Status Bar . . . . .                                 | 34 |
| 5. Channel Window . . . . .  | 36 |
| Rear Panel: Names and Functions of Parts . . . . .                 | 42 |
| 1. Fan . . . . .   | 43 |
| 2. Power Cable Receptacle (to LINE) . . . . .                      | 43 |
| 3. Line Switch (Always ON) . . . . .                               | 43 |
| 4. Ethernet Port . . . . .   | 43 |
| 5. Printer Parallel Port . . . . .                                 | 43 |
| 6. External Monitor Output Terminal (Video) . . . . .              | 43 |
| 7. Handler I/O Port . . . . .                                      | 44 |
| 8. External Trigger Input Connector (Ext Trig) . . . . .           | 44 |
| 9. GPIB Connector . . . . .  | 44 |
| 10. External Reference Signal Input Connector (Ref In) . . . . .   | 44 |
| 11. Internal Reference Signal Output Connector (Ref Out) . . . . . | 44 |
| 12. Certificate of Authenticity Label . . . . .                    | 45 |
| 13. Mini-DIN Mouse Port . . . . .                                  | 45 |
| 14. Mini-DIN Keyboard Port . . . . .                               | 45 |
| 15. Rear USB port . . . . .  | 45 |
| 16. Reserved Port (Reserved) . . . . .                             | 45 |
| 17. Serial Number Plate . . . . .                                  | 45 |
| <b>3. Setting Measurement Conditions</b>                           |    |
| Initializing Settings . . . . .                                    | 48 |
| Setting Channels and Traces . . . . .                              | 49 |
| Setting channel display (layout of channel windows) . . . . .      | 49 |
| Setting trace display . . . . .                                    | 51 |

|   |    |
|---|----|
| Active channel . . . . .  | 53 |
| Active trace . . . . .  | 53 |
| Setting target for each setting item (range to which setting affects) . . . . . | 54 |
| Setting the System Z0 . . . . .   | 56 |
| Setting Stimulus Conditions . . . . .   | 57 |
| Setting sweep type . . . . .  | 57 |
| Setting the Sweep Range . . . . .   | 57 |
| On/off of stimulus signal output . . . . .                                      | 60 |
| Setting fixed frequency at power sweep . . . . .                                | 60 |
| Setting power level at frequency sweep . . . . .                                | 61 |
| Setting the Number of Points . . . . .  | 63 |
| Setting the Sweep Time . . . . .  | 63 |
| Selecting Measurement Parameters . . . . .                                      | 65 |
| Definition of S-Parameters . . . . .  | 65 |
| Setting Up S-Parameters . . . . .   | 65 |
| Selecting a Data Format . . . . .   | 66 |
| Rectangular Display Formats . . . . .   | 66 |
| Polar Format . . . . .  | 67 |
| Smith Chart Format . . . . .  | 68 |
| Selecting a Data Format . . . . .   | 69 |
| Setting the Scales . . . . .  | 70 |
| Auto Scale . . . . .  | 70 |
| Manual Scale Adjustment on a Rectangular Display Format . . . . .               | 70 |
| Manual Scale Adjustment on the Smith Chart/Polar Format . . . . .               | 72 |
| Setting the Value of a Reference Line Using the Marker . . . . .                | 72 |
| Setting Window Displays . . . . .   | 73 |
| Maximizing the Specified Window/Trace Display . . . . .                         | 73 |
| Turning Off the Display of Graticule Labels . . . . .                           | 73 |
| Displaying the Graticule Label Display Using Relative Values . . . . .          | 74 |
| Hiding Frequency Information . . . . .  | 75 |
| Labeling a Window . . . . .   | 76 |
| Setting display colors . . . . .  | 77 |
| <br>  |    |
| <b>4. Calibration</b>   |    |
| Measurement Errors and their Characteristics . . . . .                          | 80 |
| Drift Errors . . . . .  | 80 |
| Random Errors . . . . .   | 80 |
| Systematic Errors . . . . .   | 81 |
| Calibration Types and Characteristics . . . . .                                 | 85 |
| Checking Calibration Status . . . . .   | 86 |
| Execution status of error correction for each channel . . . . .                 | 86 |
| Execution status of error correction for each trace . . . . .                   | 86 |
| Acquisition status of calibration coefficient for each channel . . . . .        | 87 |
| Selecting Calibration Kit . . . . .   | 88 |
| OPEN/SHORT Response Calibration (Reflection Test) . . . . .                     | 89 |
| Procedure . . . . .   | 89 |
| THRU Response Calibration (Transmission Test) . . . . .                         | 92 |
| Procedure . . . . .   | 92 |
| 1-Port Calibration (Reflection Test) . . . . .                                  | 95 |



|   |     |
|---|-----|
| Procedure . . . . .   | 95  |
| Enhanced Response Calibration . . . . .   | 97  |
| Procedure . . . . .   | 98  |
| Full 2-Port Calibration . . . . .   | 100 |
| Procedure . . . . .   | 101 |
| ECal (Electronic Calibration) . . . . .   | 103 |
| 1-Port Calibration Using the ECal Module . . . . .  | 103 |
| Enhanced Response Calibration Using the ECal Module . . . . .   | 104 |
| Full 2-Port Calibration Using the ECal Module . . . . .   | 105 |
| Changing the Calibration Kit Definition . . . . .   | 107 |
| Definitions of Terms . . . . .  | 107 |
| Defining Parameters for Standards . . . . .   | 108 |
| Redefining a Calibration Kit . . . . .  | 110 |
| Default Settings of Pre-defined Calibration Kits . . . . .  | 113 |
| <br>  |     |
| <b>5. Making Measurements</b>   |     |
| Setting Up the Trigger and Making Measurements . . . . .  | 120 |
| Sweep Order in Each Channel . . . . .   | 120 |
| Trigger Source . . . . .  | 121 |
| Trigger Modes . . . . .   | 121 |
| Setting Up the Trigger and Making Measurements . . . . .  | 122 |
| <br>  |     |
| <b>6. Data Analysis</b>   |     |
| Analyzing Data on the Trace Using the Marker . . . . .  | 124 |
| About Marker Functions . . . . .  | 124 |
| Reading Values on the Trace . . . . .   | 125 |
| Reading the Relative Value From the Reference Point on the Trace . . . . .                                    | 128 |
| Reading Only the Actual Measurement Point/Reading the Value Interpolated Between Measurement Points . . . . . | 129 |
| Setting Up Markers for Each Trace/Setting Up Markers for Coupled Operations Between Traces . . . . .          | 130 |
| Listing All the Marker Values in All the Channels Displayed . . . . .   | 131 |
| Specifying the display position of marker values . . . . .  | 132 |
| Aligning maker value displays . . . . .   | 133 |
| Displaying all marker values for displayed traces . . . . .   | 134 |
| Searching for Positions that Match Specified Criteria . . . . .   | 135 |
| Setting Search Range . . . . .  | 135 |
| Automatically Executing a Search Each Time a Sweep is Done (Search Tracking) . . . . .                        | 136 |
| Searching for the Maximum and Minimum Measured Values . . . . .   | 137 |
| Searching for the Target Value (Target Search) . . . . .  | 138 |
| Searching for the Multiple Target Values (Multi-target Search) . . . . .                                      | 140 |
| Searching for the Peak . . . . .  | 142 |
| Searching for Multiple Peaks . . . . .  | 144 |
| Determining the Bandwidth of the Trace (Bandwidth Search) . . . . .   | 146 |
| Executing a Bandwidth Search . . . . .  | 147 |
| Obtaining the bandwidth of a trace (notch search) . . . . .   | 148 |
| Executing a notch Search . . . . .  | 149 |
| Determining the Mean, Standard Deviation, and p-p of the Trace . . . . .                                      | 150 |
| Displaying Statistics Data . . . . .  | 150 |

|   |     |
|---|-----|
| Obtaining Span, Gain, Slope, and Flatness between Markers . . . . .           | 151 |
| Operational procedure. . . . .  | 151 |
| Obtaining Loss, Ripple, and Attenuation of the RF Filter . . . . .            | 152 |
| Operational procedure. . . . .  | 152 |
| Comparing Traces/Performing Data Math . . . . .                               | 153 |
| Performing Data Math Operations . . . . .                                     | 153 |
| Performing parameter conversion of measurement result . . . . .               | 155 |
| Operational procedure. . . . .  | 155 |
| <br>  |     |
| <b>7. Data Output</b>   |     |
| Saving and Recalling Instrument State. . . . .                                | 158 |
| Compatibility of files related to saving and recalling. . . . .               | 158 |
| Save procedure . . . . .  | 160 |
| Recall procedure . . . . .  | 163 |
| Recall Procedure Using “Recall by File Name” Feature . . . . .                | 163 |
| Order of recalling the configuration file at startup . . . . .                | 164 |
| Saving/recalling instrument state for each channel into/from memory . . . . . | 165 |
| Operational procedure. . . . .  | 165 |
| Saving/Recalling Calibration Data for Each Channel into/from Memory . . . . . | 166 |
| Operational Procedure . . . . .   | 166 |
| Saving Trace Data to a File . . . . .   | 167 |
| Saving data as a CSV file . . . . .   | 167 |
| Saving data in Touchstone format. . . . .                                     | 168 |
| Saving the Screen Image to a File . . . . .                                   | 171 |
| Saving the Screen Image to a File . . . . .                                   | 171 |
| Organizing Files and Folders . . . . .  | 172 |
| To open Windows Explorer . . . . .  | 172 |
| To copy a file or folder . . . . .  | 172 |
| To move a file or folder . . . . .  | 173 |
| To delete a file or folder . . . . .  | 173 |
| To rename a file or folder . . . . .  | 173 |
| To format a floppy disk. . . . .  | 173 |
| Printing Displayed Screen . . . . .   | 174 |
| Available printers (supported printers). . . . .                              | 174 |
| Printed/saved images . . . . .  | 175 |
| Print procedure . . . . .   | 175 |
| Installing printer driver . . . . .   | 177 |
| <br>  |     |
| <b>8. Limit Test</b>  |     |
| Limit Test . . . . .  | 180 |
| Concept of limit test . . . . .   | 180 |
| Displaying judgment result of limit test . . . . .                            | 181 |
| Defining the Limit Line . . . . .   | 182 |
| Changing the limit line display method . . . . .                              | 186 |
| Turning the Limit Test ON/OFF . . . . .                                       | 187 |
| Initializing the Limit Table . . . . .  | 187 |
| Offsetting trace data . . . . .   | 188 |

**9. Optimizing Measurements**

|   |     |
|---|-----|
| Expanding the Dynamic Range . . . . .   | 192 |
| Lowering the Receiver Noise Floor . . . . .                                   | 192 |
| Reducing Trace Noise. . . . .   | 195 |
| Turning on Smoothing. . . . .   | 195 |
| Improving the Accuracy of Phase Measurements . . . . .                        | 197 |
| Electrical Delay . . . . .  | 197 |
| Port Extension . . . . .  | 198 |
| Phase Offset. . . . .   | 199 |
| Specifying the Velocity Factor . . . . .                                      | 199 |
| Improving the Measurement Throughput . . . . .                                | 200 |
| Turning Off the Updating of Information Displayed on the LCD Screen . . . . . | 200 |
| Performing a Segment-by-Segment Sweep (Segment Sweep). . . . .                | 201 |
| Concept of the Segment Sweep. . . . .   | 201 |
| Conditions for Setting Up a Segment Sweep . . . . .                           | 202 |
| Items that can be set for each segment . . . . .                              | 202 |
| Sweep Delay Time and Sweep Time in a Segment Sweep. . . . .                   | 203 |
| Frequency Base Display and Order Base Display . . . . .                       | 203 |
| Procedure. . . . .  | 205 |

**10. Setting and Using the Control and Management Functions**

|  |     |
|--|-----|
| Setting the GPIB . . . . .   | 212 |
| Setting talker/listener GPIB address of E5061A/E5062A . . . . .        | 212 |
| Setting system controller (USB/GPIB interface) . . . . .               | 212 |
| Setting the Internal Clock . . . . .                                   | 215 |
| Setting the Date and Time . . . . .                                    | 215 |
| Setting the Date/Time Display ON/OFF . . . . .                         | 216 |
| Setting the Mouse . . . . .  | 217 |
| Setup Step . . . . .   | 217 |
| Configuring the Network . . . . .                                      | 220 |
| Enabling/disabling network. . . . .                                    | 220 |
| Setting IP address . . . . .   | 221 |
| Specifying computer name . . . . .                                     | 223 |
| Remote Control Using HTTP. . . . .                                     | 225 |
| Required Modification of Settings . . . . .                            | 225 |
| How to Start VNC Server Configuration . . . . .                        | 225 |
| Accessing Hard Disk of E5061A/E5062A from External PC . . . . .        | 227 |
| Enabling the access form the external PC. . . . .                      | 227 |
| Accessing hard disk of E5061A/E5062A from external PC. . . . .         | 229 |
| Locking the Front Keys, Keyboard, and/or Mouse (Touch Screen). . . . . | 230 |
| Locking the Front Keys, Keyboard, and/or Mouse. . . . .                | 230 |
| Setting the Beeper (Built-in Speaker). . . . .                         | 231 |
| Setting the Operation Complete Beeper . . . . .                        | 231 |
| Setting the Warning Beeper. . . . .                                    | 231 |
| Turning off the LCD Screen Backlight. . . . .                          | 232 |
| Turning off the LCD Screen Backlight . . . . .                         | 232 |
| Checking the product information . . . . .                             | 233 |
| Checking the serial number. . . . .                                    | 233 |
| Checking the Firmware Revision . . . . .                               | 233 |

|   |     |
|---|-----|
| Setting the preset function . . . . .                               | 234 |
| Showing/hiding the confirmation buttons when presetting . . . . .   | 234 |
| Setting the user preset function . . . . .                          | 234 |
| Saving a user-preset instrument state . . . . .                     | 235 |
| System Recovery . . . . .   | 236 |
| Types of system recoveries . . . . .                                | 236 |
| Notes on executing the factory recovery function . . . . .          | 236 |
| Procedure to execute the factory recovery function . . . . .        | 237 |
| Procedure to create the user backup image . . . . .                 | 240 |
| Procedure to execute the user recovery function . . . . .           | 243 |
| Calibration of the Touch Screen . . . . .                           | 246 |
| <br>  |     |
| <b>11. Measurement Examples</b>                                     |     |
| Measuring the SAW Bandpass Filter Using the Segment Sweep . . . . . | 248 |
| Evaluation Steps . . . . .  | 248 |
| 1. Determine the Segment Sweep Conditions . . . . .                 | 249 |
| 2. Create a Segment Sweep Table . . . . .                           | 250 |
| 3. Select the Segment Sweep as the Sweep Type . . . . .             | 252 |
| 4. Execute the Calibration . . . . .                                | 252 |
| 5. Connect the DUT . . . . .  | 253 |
| 6. Execute the Measurement . . . . .                                | 253 |
| 7. Define the Setup for Display . . . . .                           | 253 |
| Measuring the Deviation from a Linear Phase . . . . .               | 255 |
| Evaluation Steps . . . . .  | 255 |
| 1. Connect the DUT . . . . .  | 255 |
| 2. Define the Measurement Conditions . . . . .                      | 256 |
| 3. Execute the Calibration . . . . .                                | 256 |
| 4. Connect the DUT and Execute the Auto Scale . . . . .             | 256 |
| 5. Specify the Electrical Delay . . . . .                           | 257 |
| 6. Measure the Deviation from a Linear Phase . . . . .              | 258 |
| <br>  |     |
| <b>12. Specifications and Supplemental Information</b>              |     |
| Definitions . . . . .   | 260 |
| Corrected System Performance . . . . .                              | 261 |
| Uncorrected System Performance . . . . .                            | 266 |
| Test Port Output (Source) . . . . .                                 | 267 |
| Test Port Input . . . . .   | 268 |
| General Information . . . . .                                       | 271 |
| Measurement Throughput Summary . . . . .                            | 277 |
| Measurement capabilities . . . . .                                  | 279 |
| Source control . . . . .  | 280 |
| Trace functions . . . . .   | 280 |
| Data accuracy enhancement . . . . .                                 | 281 |
| Storage . . . . .   | 282 |
| System capabilities . . . . .                                       | 282 |
| Automation . . . . .  | 283 |
| <br>  |     |
| <b>13. Information on Maintenance</b>                               |     |

|  |     |
|--|-----|
| Backing Up the Data . . . . .  | 286 |
| Making Backup Files . . . . .  | 286 |
| Cleaning this Instrument . . . . .   | 287 |
| Cleaning an LCD . . . . .  | 287 |
| Maintenance of Test Ports and Other Connectors/Ports . . . . .                           | 287 |
| Cleaning a Display Other than an LCD . . . . .   | 287 |
| Replacement of Parts with Limited Service Life . . . . .                                 | 288 |
| Cautions Applicable to Requesting Repair, Replacement, Regular Calibration, etc. . . . . | 289 |
| Backing Up Data in the Hard Disk . . . . .   | 289 |
| Devices to be Sent Back for Repair or Regular Calibration . . . . .                      | 289 |
| Recommended Calibration Period . . . . .   | 289 |
| <b>A. Manual Changes</b>   |     |
| Manual Changes . . . . .   | 292 |
| Change 1 . . . . .   | 293 |
| <b>B. Troubleshooting</b>  |     |
| Troubleshooting . . . . .  | 296 |
| Troubleshooting during Startup . . . . .   | 296 |
| Troubleshooting during Operation . . . . .   | 297 |
| Troubleshooting for External Devices . . . . .   | 300 |
| Error Messages . . . . .   | 301 |
| A . . . . .  | 301 |
| B . . . . .  | 301 |
| C . . . . .  | 301 |
| D . . . . .  | 302 |
| E . . . . .  | 302 |
| F . . . . .  | 302 |
| G . . . . .  | 304 |
| H . . . . .  | 304 |
| I . . . . .  | 304 |
| L . . . . .  | 305 |
| M . . . . .  | 305 |
| N . . . . .  | 305 |
| O . . . . .  | 306 |
| P . . . . .  | 306 |
| Q . . . . .  | 307 |
| R . . . . .  | 308 |
| S . . . . .  | 308 |
| T . . . . .  | 309 |
| U . . . . .  | 309 |
| Warning Message . . . . .  | 310 |
| <b>C. List of Default Values</b>   |     |
| List of Default Values, Save/Recall Settings, and Backup Settings . . . . .              | 314 |
| <b>D. Softkey Functions</b>  |     |
| E5061A/E5062A Menu (Top Menu) . . . . .  | 322 |

|   |     |
|---|-----|
| Analysis Menu . . . . .                                       | 323 |
| Average Menu . . . . .  | 324 |
| Calibration Menu . . . . .                                    | 325 |
| Display Menu . . . . .  | 331 |
| Format Menu . . . . .   | 334 |
| Macro Setup Menu . . . . .                                    | 335 |
| Marker Menu . . . . .   | 337 |
| Marker Function Menu . . . . .                                | 339 |
| Marker Search Menu . . . . .                                  | 340 |
| Measurement Menu . . . . .                                    | 344 |
| Preset Menu . . . . .   | 345 |
| Save/Recall Menu . . . . .                                    | 346 |
| Scale Menu . . . . .  | 349 |
| Stimulus Menu . . . . .                                       | 350 |
| Sweep Setup Menu . . . . .                                    | 351 |
| System Menu . . . . .   | 353 |
| Trigger Menu . . . . .  | 357 |
| <br>  |     |
| <b>E. General Principles of Operation</b>                     |     |
| System Description . . . . .                                  | 360 |
| Synthesized Source . . . . .                                  | 360 |
| Source Switcher . . . . .                                     | 361 |
| Signal Separator . . . . .                                    | 361 |
| Receiver . . . . .  | 361 |
| Data Processing . . . . .                                     | 362 |
| ADC . . . . .   | 362 |
| Digital Filter . . . . .                                      | 362 |
| IF Range Correction . . . . .                                 | 363 |
| Ratio Calculation . . . . .                                   | 363 |
| Port Characteristics Correction . . . . .                     | 363 |
| Sweep Averaging . . . . .                                     | 363 |
| Raw Data Array . . . . .                                      | 363 |
| Error Correction/Error Correction Coefficient Array . . . . . | 363 |
| Port Extension . . . . .                                      | 363 |
| Corrected Data Array . . . . .                                | 363 |
| Corrected Memory Array . . . . .                              | 363 |
| Data Math . . . . .   | 364 |
| Electrical Delay/Phase Offset . . . . .                       | 364 |
| Data Format/Group Delay . . . . .                             | 364 |
| Smoothing . . . . .   | 364 |
| Reference tracking . . . . .                                  | 364 |
| Formatted Data Array/Formatted Memory Array . . . . .         | 364 |
| Offset/Scale . . . . .  | 364 |
| Display . . . . .   | 364 |

---

# 1 Precautions

This chapter describes cautions that must be observed in operating the E5061A/E5062A.

## **Software Installed**

The Windows operating system installed in this machine is customized for more effective operation, and has different functions that are not part of the Windows operating system for ordinary PCs (personal computers).

Therefore, do not attempt to use the system in ways other than those described in this manual or to install Windows-based software (including anti-virus software) for ordinary PCs as doing so may cause malfunctions.

Also note the followings.

- Do not update the Windows operating system installed in this machine to the Windows operating system for ordinary PCs. Doing so will cause malfunctions.
- Do not attempt to update VBA (Visual Basic for Applications) software installed in this machine to its equivalent developed for ordinary PCs. Doing so will cause malfunctions.
- Do not allow any computer virus to infect the system. This machine has no virus check function nor anti-virus software installed.

Agilent Technologies will not be held liable for any failure or damage arising from negligence regarding these prohibitions and warnings.

---

### **NOTE**

If the pre-installed software is damaged somehow, resulting in errant behavior by the machine, perform a system recovery. For further details of system recovery, refer to “System Recovery” on page 236.

---



---

## 2 Overview of Functions

This chapter describes the functions of the E5061A/E5062A that can be accessed from the front panel, LCD screen, and rear panel.

## Front Panel: Names and Functions of Parts

This section describes the names and functions of parts on the front panel of the E5061A/E5062A. For more about the functions displayed on the LCD screen, see “Screen Area: Names and Functions of Parts” on page 30. For more about the functions of softkeys, see Appendix D, “Softkey Functions,” on page 321.

**Figure 2-1** Front Panel

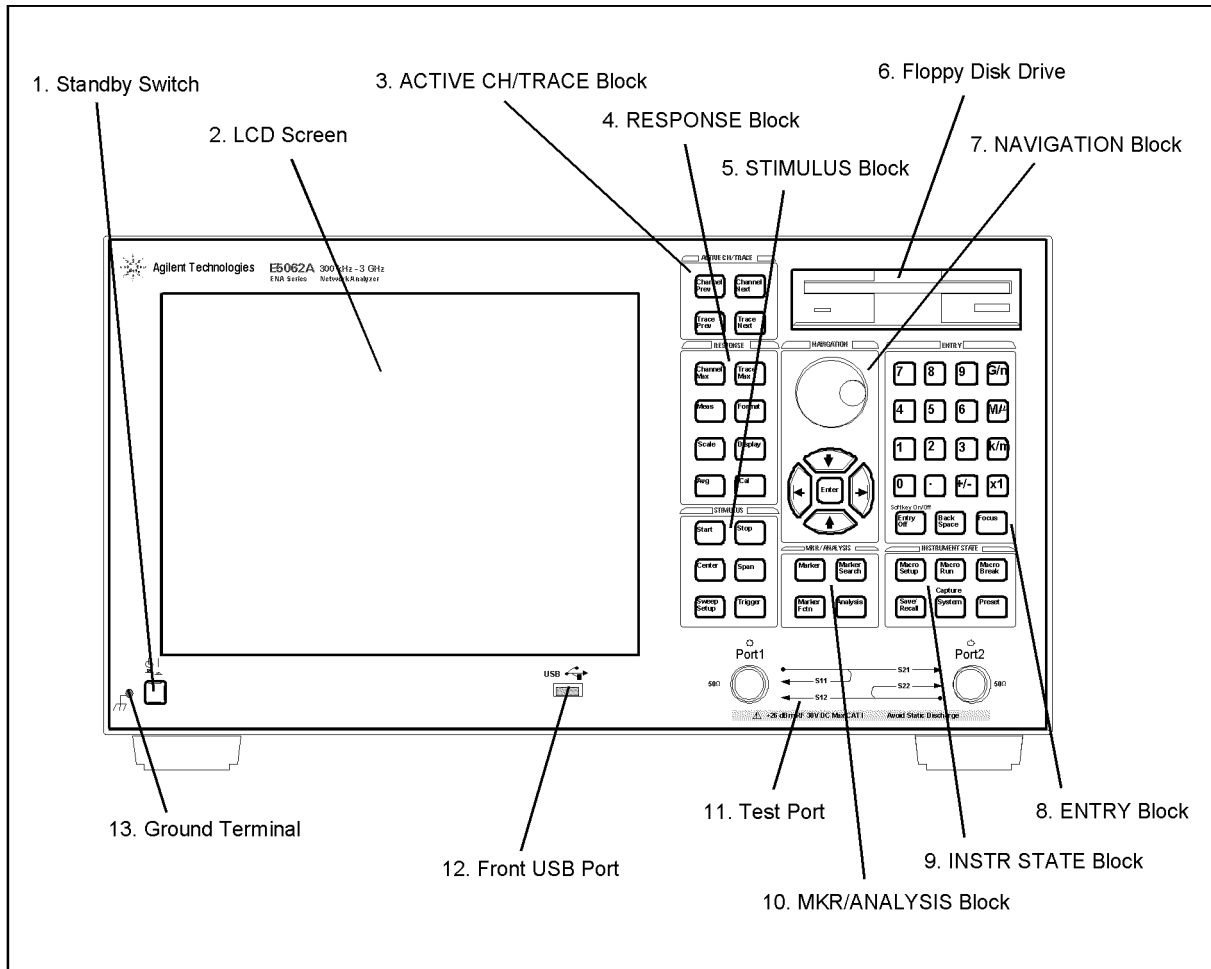

e5061aqe008

## 1. Standby Switch

Used for choosing between power-on ( | ) and standby (  ) states of the E5061A/E5062A.

---

### NOTE

To turn off the power for the E5061A/E5062A, be sure to follow the steps described below.

1. First, press this standby switch, or send a shutdown command from the external controller to activate the shutdown process (the processing of software and hardware necessary to turn off the power supply). This will put the E5061A/E5062A into the standby state.
2. Next, if necessary, turn off the power supply to the “2. Power Cable Receptacle (to LINE)” on page 43 on the rear panel.

**Under normal use, never directly interrupt the power supply to the power cable receptacle on the rear panel when the power supply is on. Always keep the “3. Line Switch (Always ON)” on page 43 at ( | ). Never turn it off (  ).**

If you directly interrupt the power supply to the power cable receptacle when the power supply is on, or turn off the “3. Line Switch (Always ON)” on page 43, the shutdown process will not work. This could damage the software and hardware of the E5061A/E5062A and lead to device failure.

Turning on the power supply after a faulty shutdown may cause the system to start up in a condition called “safe mode”. If this occurs, first shut down the system to put it into the standby state, and then turn on the power supply again and start up the system in normal mode.

For more about turning the power supply on/off and putting it into the standby state, see Chapter 1 “Installation Guide” in the *Installation and Quick Start Guide*.

---

## 2. LCD Screen

A 10.4-inch TFT color LCD used for displaying traces, scales, settings, softkeys, etc. Either a standard color LCD or touch screen color LCD (Option 016) are available. The touch screen LCD allows you to manipulate softkeys by touching the LCD screen directly with the finger. For more about the LCD screen, see “Screen Area: Names and Functions of Parts” on page 30.

---

### NOTE

**Do not press the surface of the LCD screen (both standard and touch screen types) with a sharp object (e.g., a nail, pen, or screwdriver).** Pressing the surface with a sharp-pointed object will damage the LCD screen surface or cause the screen to fail. Be especially careful when using a touch screen LCD.

---

### NOTE

**Occasionally, a few pixels may appear on the screen as a fixed point of blue, green or red. Please note that this is not a failure and does not affect the performance of your product.**

### 3. ACTIVE CH/TRACE Block

A group of keys for selecting active channels and traces. For more about the concepts of channels and traces, see “Setting Channels and Traces” on page 49.

**Channel Next** Key

Select the next channel as the active channel. (Each time the key is pressed causes the active channel to step up from the channel with the currently designated number to one with a larger channel number.) An active channel is one for which the sweep range, etc. are defined. To change the settings for a channel, use this key to first make the channel active.

**Channel Prev** Key

Select the previous channel as the active channel. (Each time the key is pressed causes the active channel to step down from the channel with the currently designated number to one with a smaller channel number.)

**Trace Next** Key

Select the next trace as the active trace. (Each time the key is pressed causes the active trace to step up from the trace with the currently designated number to one with a larger channel number.) An active trace is one for which the measurement parameters, etc. are defined. To change the settings for a trace, use this key to first make the trace active.

**Trace Prev** Key

Select the previous trace as the active trace. (Each time the key is pressed causes the active trace to step down from the trace with the currently designated number to one with a smaller trace number.)









## 4. RESPONSE Block

A group of keys used mainly for setting up response measurements on the E5061A/E5062A.

|                        |   |
|------------------------|---|
| <b>Channel Max</b> Key | Changes between normal and maximum display of the active channel window. In normal display, all the defined channel windows (both active and non-active) are displayed in split views on the screen. In maximum display, only the active channel window is displayed over the entire area, with non-active windows not displayed. To maximize the active channel, double-click the channel window frame. Measurements are also carried out on the non-active channels that are not displayed. |
| <b>Trace Max</b> Key   | Changes between normal and maximum display of the active trace. In normal display, all traces defined on the channel (both active and non-active) are displayed on the screen. In maximum display, only the active trace is displayed over the entire area, with non-active traces not displayed. To maximize the active trace, double-click the area inside the channel window (excluding the frame). Measurements are also carried out on the non-active traces not displayed.              |
| <b>Meas</b> Key        | Displays the “Measurement Menu” on page 344 on the right side of the screen. Manipulating the “Measurement Menu” enables you to specify the measurement parameters (types of S-parameters) for each trace.  |
| <b>Format</b> Key      | Displays the “Format Menu” on page 334 on the right side of the screen. Manipulating the “Format Menu” enables you to specify the data format (data transformation and graph formats) for each trace.   |
| <b>Scale</b> Key       | Displays the “Scale Menu” on page 349 on the right side of the screen. Manipulating the “Scale Menu” enables you to specify the scale for displaying a trace (magnitude per division, value of the reference line, etc.) for each trace. You can also specify the electrical delay and phase offset for each trace.   |
| <b>Display</b> Key     | Displays the “Display Menu” on page 331 on the right side of the screen. Manipulating the “Display Menu” enables you to specify the number of channels and channel window array, the number and arrangement of traces, the setup for data math, etc.  |
| <b>Avg</b> Key         | Displays the “Average Menu” on page 324 on the right side of the screen. Manipulating the “Average Menu” enables you to define the averaging, smoothing, and IF bandwidth.  |
| <b>Cal</b> Key         | Displays the “Calibration Menu” on page 325 on the right side of the screen. Manipulating the “Calibration Menu” enables you to turn the calibration and error correction on/off and change definitions for calibration kits.   |

## 5. STIMULUS Block

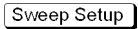
A group of keys for defining the stimulus values (signal sources and triggers).

|   |   |
|---|---|
|  Key   | Displays the data entry bar for specifying the start value of the sweep range in the upper part of the screen. (It also displays the “Stimulus Menu” on page 350 for specifying the sweep range on the right side of the screen.)                               |
|  Key   | Displays the data entry bar for specifying the stop value of the sweep range in the upper part of the screen. (It also displays the “Stimulus Menu” in the same way as  .)   |
|  Key   | Displays the data entry bar for specifying the center value of the sweep range in the upper part of the screen. (It also displays the “Stimulus Menu” in the same way as  .) |
|  Key   | Displays the data entry bar for specifying the span value of the sweep range in the upper part of the screen. (It also displays the “Stimulus Menu” in the same way as  .)   |
|  Key   | Displays the “Sweep Setup Menu” on page 351 on the right side of the screen. Manipulating the “Sweep Setup Menu” enables you to specify the signal source power level, sweep time, number of points, sweep type, etc.   |
|  Key | Displays the “Trigger Menu” on page 357 on the right side of the screen. Manipulating the “Trigger Menu” enables you to specify the trigger mode and trigger source. Specify the trigger mode for each channel.   |

## 6. Floppy Disk Drive

A device for storing to and reading from a floppy disk the setup state of the E5061A/E5062A, measurement data, calibration data, data on images displayed on the LCD screen, VBA (Visual Basic for Applications) programs, etc. The floppy disk drive is compatible with a 3.5-inch, 1.44 MB, DOS (Disk Operating System) formatted floppy disk.

A floppy disk access lamp is provided at the lower left of the floppy disk drive opening. When the floppy disk drive is accessing a disk (for reading or writing), this lamp will light up green.

A disk eject button is provided at the lower right of the floppy disk drive opening. Pressing this button causes the inserted floppy disk to be ejected.

---

### NOTE

Insert a floppy disk into the floppy disk drive opening **right side up** in the direction of the arrow marked on the disk.

**Do not press the disk eject button while the floppy disk access lamp is on.** Trying to forcefully pull the floppy disk out while the lamp is on may damage the floppy disk or disk drive.

---







## 7. NAVIGATION Block

The keys and knob in the NAVIGATION block are used to navigate between softkey menus, tables (limit table, segment table, etc.), or a selected (highlighted) area in a dialog box, or to change a numeric value in the data entry area by stepping up or down. When selecting one of two or more objects (softkey menus, data entry areas, etc.) to manipulate with the NAVIGATION block keys displayed on the screen, first press the  key in the “8. ENTRY Block” on page 26 to select the object to be manipulated (focus on the object) and then manipulate the NAVIGATION block keys (knob) to move your selection (highlighted object) or change numeric values.

In the following, you will see how the NAVIGATION block keys work both when the focus is on a softkey menu and when the focus is in the data entry area. For more about manipulating tables and dialog boxes, refer to the manipulation procedure for each of those functions.

### When the focus is in a softkey menu (the softkey menu is selected)







When the focus is placed on a softkey menu (the menu title area in the uppermost part is displayed in blue), the NAVIGATION block keys work as described below.

-  Knob  
(Turn clockwise or counterclockwise.) Moves the softkey selection (highlighted display) up or down.
-   Key Moves the softkey selection (highlighted display) up or down.
-  Key Displays the softkey menu one layer above.
-  Key Displays the softkey menu one layer below.
-  Knob or  key  
(to be pressed) Executes the function of the selected softkey.

After pressing the data entry softkey, the focus automatically moves to the data entry area.

### When the focus is in the data entry area (the data entry area is selected)

When the focus is placed on the data entry area (the data entry bar is displayed in blue), the NAVIGATION block keys work as described below.

-  Knob (Turn clockwise or counterclockwise.) Increases or decreases the numeric value in the data entry area in small steps.
-   Key Increases or decreases the numeric value in the data entry area in large steps.
-   Key Moves the cursor (|) in the data entry area laterally back and forth. Use it together with the “8. ENTRY Block” keys to change data one character at a time.
-  Knob or  key  
(to be pressed) Finishes the entry in the data entry area, and moves the focus to the softkey menu.

## 8. ENTRY Block

A group of keys used for entering numeric data.

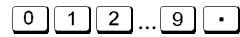

Key (Numeric key)

Type numeric characters and a decimal point at the position of the cursor in the data entry area.



Key

Alternately changes the sign (+, -) of a numeric value in the data entry area.

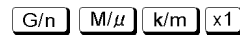

Key

Adds a prefix to the numeric data typed by using the numeric key and and then enters that data. One of the two prefixes written on the surface of the key is automatically selected depending on the parameter to be entered. is entered without a prefix being given.

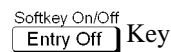

Key

Turns off the data entry bar if it is displayed. If the dialog box is displayed, cancels the entry and close the dialog box. If the data entry bar and dialog box are not displayed, turns the softkey menu display on/off.

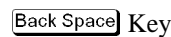

Key

Deletes a character to the left of the cursor (|) in the data entry area. When two or more characters in the data entry area are selected (highlighted), deletes all the characters selected.







Key

Changes the selection (focus) between the objects to be manipulated by the NAVIGATION block keys and ENTRY block keys. The objects to be manipulated by the NAVIGATION block keys and ENTRY block keys include softkey menus, data entry areas, tables (e.g., segment tables, limit tables, and marker tables), and dialog boxes. When two or more of these are displayed on the screen and need selecting, use this key to change the selection (focus) between the objects to be manipulated. When a softkey menu is selected, the menu name area at the top of the menu is displayed in blue. When a data entry area is selected, the data entry bar is displayed in blue. When a table is selected, the frame of the table window is displayed in light gray. While a dialog box is displayed, the focus is fixed on the dialog box and cannot be changed.

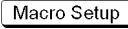

## 9. INSTR STATE Block

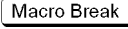
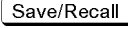
A group of the keys related to the macro function, store and call function, control/management function, and presetting the E5061A/E5062A (returning it to the preset state).

|   |   |
|---|---|
|  Key   | Displays the “Macro Setup Menu” on page 335 on the right side of the screen. Manipulating the “Macro Setup Menu” enables you to start up the VBA editor, or create, call, or store a VBA project.   |
|  Key   | Executes a VBA procedure called “main” having a VBA module named Module1.   |
|  Key   | Stops the VBA procedure being executed.   |
|  Key   | Displays the “Save/Recall Menu” on page 346 on the right side of the screen. Manipulating the “Save/Recall Menu” enables you to store to or read from the internal hard disk or floppy disk the setup conditions, calibration data, and trace data of the analyzer.   |
|  Key   | First, temporarily saves the data for the image displayed on the LCD screen the moment this key is pressed <sup>*1</sup> to the internal memory (clipboard). Immediately after, displays the “System Menu” on page 353 on the right side of the screen. Manipulating the “System Menu” enables you to define the setup for and execute the limit test or define the setup concerning the control and management of the analyzer. Using the <b>Dump Screen Image</b> key enables you to store the image data in the clipboard to a file on the internal hard disk or a floppy disk. Also, using the <b>Print</b> key in the System menu enables you to print the image data in the clipboard to a printer. |
|  Key | Displays the “Preset Menu” on page 345 on the right side of the screen. Pressing <b>OK</b> in the “Preset Menu” enables you to return the analyzer to the initial setup state, called the preset setup. For the initial setup for each of the functions, see Appendix C, “List of Default Values,” on page 313.   |

\*1. Strictly speaking, the temporary save occurs the moment the “System Menu” is manipulated. Therefore, this also occurs when the menu bar is used to execute **5 Instr State - 5 System**.

## 10. MKR/ANALYSIS Block

A group of keys used for analyzing the measurement results by using the markers, etc. For functions of the keys in the MKR/ANALYSIS block, see Chapter 2 “Overview of Functions” in the *User’s Guide*.

 Key

Displays the “Marker Menu” on page 337 on the right side of the screen. Manipulating the “Marker Menu” enables you to turn the markers on/off and move them by entering stimulus values. You can place up to 10 markers on each trace.

 Key

Displays the “Marker Search Menu” on page 340 on the right side of the screen. Manipulating the “Marker Search Menu” enables you to move a marker to a specific point (maximum, minimum, peak, and a point with a target value) on a trace. You can also find the bandwidth parameters (up to six) and display them.

 Key

Displays the “Marker Function Menu” on page 339 on the right side of the screen. Manipulating the “Marker Function Menu” enables you to not only specify the marker sweep range and coupling of markers on a channel but also display statistics data on traces.

 Key

Displays the “Analysis Menu” on page 323 on the right side of the screen. Manipulating the “Analysis Menu” enables you to use various analytical functions.

## 11. Test Port

A port to which the DUT is connected. Option 150 and 250 each has two ports with 50  $\Omega$ , N-type, female connectors, Option 175 and 275 each has two ports with 75  $\Omega$ , N-type, female connectors. While signals are being output from a test port, the yellow LED above the test port lights up.

---

### CAUTION



Do not apply a DC voltage or current to the test port. Applying a DC voltage or current may lead to device failure. In particular, there is a possibility of the capacitor remaining charged. Connect the measurement sample (DUT) to the test port (or the test fixture, cables, etc. connected to the test port) after the analyzer has been completely discharged.

The test ports comply with Installation Category I of IEC 61010-1 and Measurement Category I of IEC 61010-1.

## 12. Front USB Port

A USB (Universal Serial Bus) port (number of parts: 1) specifically for an ECal (Electronic Calibration) module, a USB/GPIB interface, or a printer. Connecting a designated ECal module to this port enables ECal measurement to be performed. Connecting a designated printer to this port enables screen information on the E5061A/E5062A to be printed to the printer. For more about executing ECal measurements, see Chapter 4, “Calibration,” on page 79, and for printing to a printer, see “Printing Displayed Screen” on page 174. The specifications of this port are identical to the “15. Rear USB port” on page 45.

---

**NOTE**

---

We do not support connections to the USB port of devices other than designated printers, ECal modules, a USB/GPIB interface, and multiport test sets.

## 13. Ground Terminal

Connected to the chassis of the E5061A/E5062A. You can connect a banana type plug to this terminal.

## Screen Area: Names and Functions of Parts

This section describes the names and functions of parts on the LCD screen of the E5061A/E5062A.

Figure 2-2 Screen Display

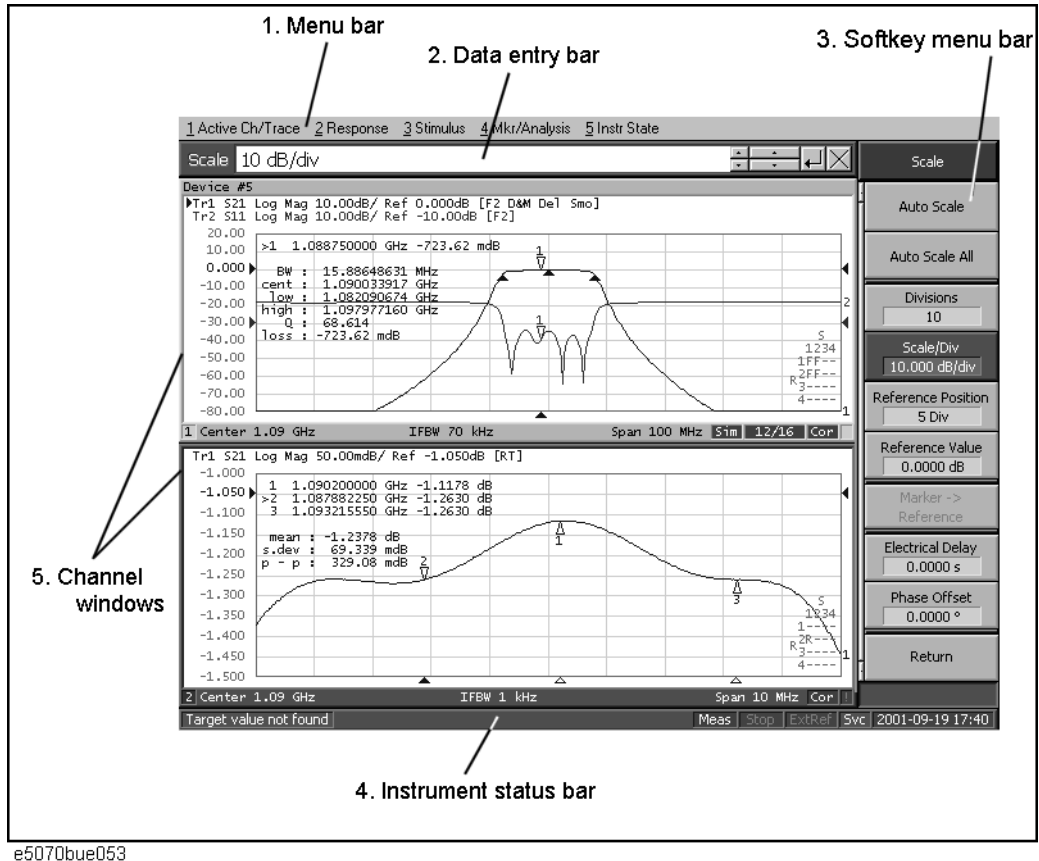

### 1. Menu Bar

By using the mouse and keyboard to manipulate the menu bar, you can perform interface operations that are equivalent to those of the keys in the ACTIVE CH/TRACE block, RESPONSE block, STIMULUS block, MKR/ANALYSIS block, and INSTR STATE block on the front panel of the E5061A/E5062A. The menus on the menu bar correspond to the key blocks, and their submenus to the hardkeys inside the key blocks.

### 2. Data Entry Bar

Used to enter numeric data into the E5061A/E5062A. Press a hardkey or softkey to enter data, and the data entry bar will appear at the top of the screen. To assign a title to a channel window, an entry bar that allows you to enter letters and symbols by using the front panel keys or mouse is displayed instead.

Figure 2-3 Data Entry Bar

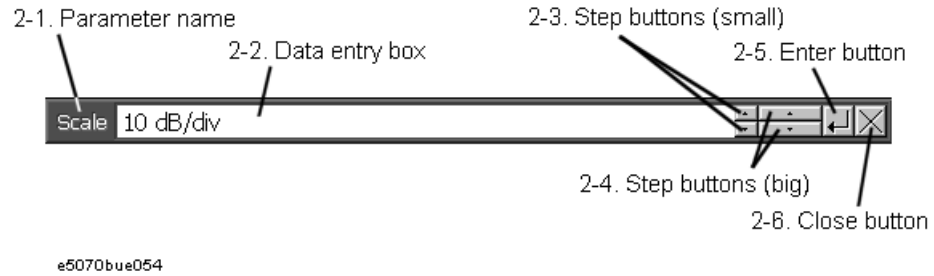

**NOTE**

To manipulate the data entry bar using the front panel keys, the data entry bar must be selected as the object to be manipulated (with the focus placed on it). When the focus is placed on the data entry bar, the entire bar is displayed in blue. Pressing or clicking **Focus** in the “8. ENTRY Block” on page 26 enables you to move the focus to the desired object.

**2-1. Parameter Name**

Displays the name of the parameter for which data will be entered.

**2-2. Data Entry Area**

When the data entry bar is displayed for the first time, the current settings are displayed on it. You can change numeric values by typing from the keyboard or in the ENTRY block on the front panel.

You can hide the frequency information in order to ensure its confidentiality or for other reasons. For detailed information, see “Hiding Softkey's Frequency Information” on page 75.

**2-3. Step Button (Small)**

Increases or decreases the numeric value in the data entry area in small steps. Use the mouse to manipulate this button.

**2-4. Step Button (Large)**

Increases or decreases the numeric value in the data entry area in large steps. Use the mouse to manipulate this button.

**2-5. Enter Button**

After typing numeric values in the data entry area by using the keyboard or the numeric keys in the ENTRY block on the front panel, press this button to finish the entry. Use the mouse to manipulate this button.

**2-6. Close Button**

Closes the data entry area (turns off the display). Use the mouse to manipulate this button.

### 3. Softkey Menu Bar

A group of keys on the screen called by the hardkeys and menu bars. You can manipulate these keys by using the NAVIGATION block keys on the front panel, the mouse, or the keyboard. When a touch screen LCD (Option 016) is used, you can perform manipulations by directly touching the screen with your finger instead of using a mouse.

Figure 2-4 Softkey Menu Bar

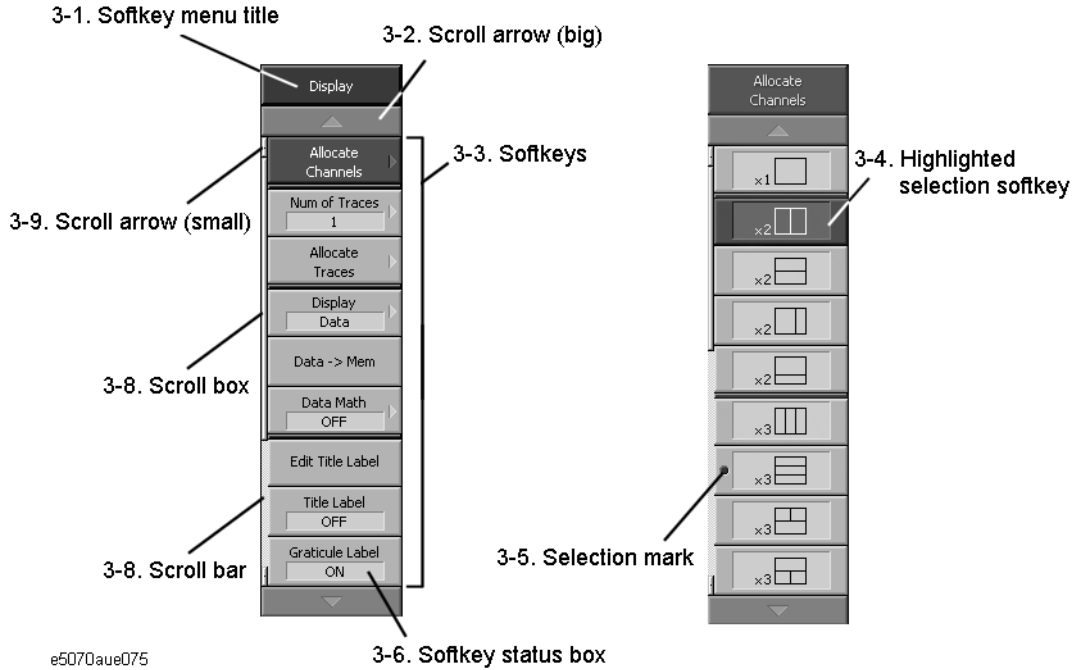

**NOTE**

To manipulate a menu bar, it has to be selected as the object to be manipulated (with the focus placed on it). When the focus is placed on a menu bar, the menu title area at the top is displayed in blue. Pressing or clicking on **Focus** of “8. ENTRY Block” on page 26 enables you to move the focus to the desired object.

#### 3-1. Softkey Menu Title

The title of the softkey menu is displayed here. Double-clicking on this part of the menu bar displays the top layer of softkeys.













#### 3-2. Scroll Arrow (Large)

When the softkeys in a menu overflow the screen, using this key enables you to scroll the menu page by page. Both upward and downward scroll arrows are available. Use the mouse to manipulate these buttons.

#### 3-3. Softkeys

These are the actual keys you would use to perform setup. A ► displayed to the right of a softkey indicates that pressing that softkey will display the lower layer of softkeys.

### 3-4. Highlighted Softkey

Pressing  and  on the front panel or pressing  on the keyboard causes the highlighted (selected) softkey to be executed. You can change which softkey in the menu is highlighted by turning  or pressing   on the front panel, or by pressing   on the keyboard. Pressing the  key on the front panel or the  key on the keyboard brings up the upper level softkey menu and pressing the  key on the front panel or the  key on the keyboard brings up the lower level softkey menu.

### 3-5. Selection Mark

Shows which softkey function is currently selected.

### 3-6. Softkey Status Display

Displays the setup status of that softkey.

### 3-7. Scroll Bar

When the softkeys in a menu overflow the screen, clicking on the blank part of this scroll bar enables you to scroll the softkey menu up or down.

### 3-8. Scroll Box

You can scroll the softkey menu up or down by using the mouse to select and drag the scroll box (pressing the button on the object to be moved and then releasing the button at the desired location). The length and position of the scroll box represent the ratio and position of the currently displayed part to the length of the entire softkey menu.

### 3-9. Scroll Arrow (Small)

Using this button, you can scroll the menu one softkey at a time. Both upward and downward scroll arrows are available. Use the mouse to manipulate these buttons.

## 4. Instrument Status Bar

The bar that displays the status of the entire instrument.

**Figure 2-5**

**Instrument Status Bar**

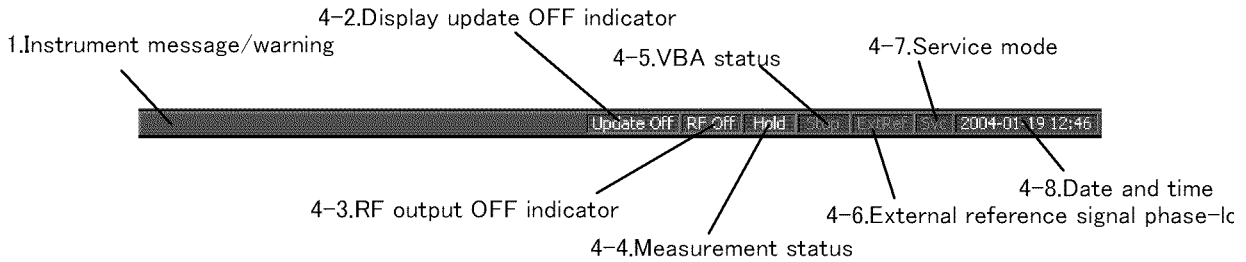

e5061aue052

### 4-1. Instrument Message/Warning

Displays instrument messages and warnings. Instrument messages are displayed in gray and warnings in red. For the meanings of the instrument messages and warnings, see Appendix B, “Troubleshooting,” on page 295

### 4-2. Display update OFF indicator

When updating of information displayed on the LCD screen is turned off, this indicator is displayed.

### 4-3. Rf output OFF indicator

When the stimulus signal output is turned off, this indicator is displayed.

### 4-4. Measurement Status

Displays the measurement status of the E5061A/E5062A.

|              |  |
|--------------|--|
| <b>Setup</b> | Setup for measurement in progress                                |
| <b>Hold</b>  | Measurement on hold (idling)                                     |
| <b>Init</b>  | Measurement being initialized                                    |
| <b>Man</b>   | The trigger source is set to “Manual” and waiting for trigger.   |
| <b>Ext</b>   | The trigger source is set to “External” and waiting for trigger. |
| <b>Bus</b>   | The trigger source is set to “Bus” and waiting for trigger.      |
| <b>Meas</b>  | A measurement is in progress.                                    |

### 4-5. VBA Status

Displays the state of the execution of the VBA program in the E5061A/E5062A.

|             |                                     |
|-------------|-------------------------------------|
| <b>Run</b>  | A VBA program is currently running. |
| <b>Stop</b> | A VBA program has stopped.          |



#### 4-6. External Reference Signal Phase Lock

When the frequency reference signal is input to the “10. External Reference Signal Input Connector (Ref In)” on page 44 on the rear panel, and the measurement signal of the E5061A/E5062A is phase-locked to the reference signal, **ExtRef** is displayed in blue.

- ExtRef** (displayed in blue) Measurement signal is phase-locked to the external reference signal
- ExtRef** (displayed in gray) Measurement signal is not phase-locked to the external reference signal.

#### 4-7. Service Mode

Indicates the service mode status.

- SVC** (displayed in blue) The E5061A/E5062A is in service mode, which is used for self-diagnosis and repair of the E5061A/E5062A. Therefore, measurement performance will not be guaranteed according to the specifications. If, under normal use, the system remains in the service mode and does not return to normal operating mode, there is a possibility that the instrument is out of order.
- SVC** (displayed in red) An abnormal condition has been detected inside the E5061A/E5062A. The unit may be damaged. Contact the Customer Contact listed at the end of this brochure or the distributor from whom the unit was purchased.
- SVC** (displayed in gray) The E5061A/E5062A is in normal mode.

#### 4-8. Date / Time

Displays the date and time generated by the internal clock. The display format is as follows:

- YYYY-MM-DD HH:MM**      **YYYY:** Year (AD)  
   **MM:** Month  
   **DD:** Day  
   **HH:MM:** Time (0:00 to 23:59)

You can turn the date and time display on/off by manipulating the keys: **System** - **Clock Setup** - **Show Clock**.

## 5. Channel Window

Windows for displaying traces. Because a channel corresponds to a window, it is called a channel window. When the outer frame of a channel window is displayed in light gray, the channel is the active channel (the channel for which setup is being performed). In Figure 2-2 on page 30, channel 1 (the upper window) is the active channel. To make a channel active, use **Channel Next** or **Channel Prev**. Clicking inside a channel window will also make a channel active.

Figure 2-6 Channel Window

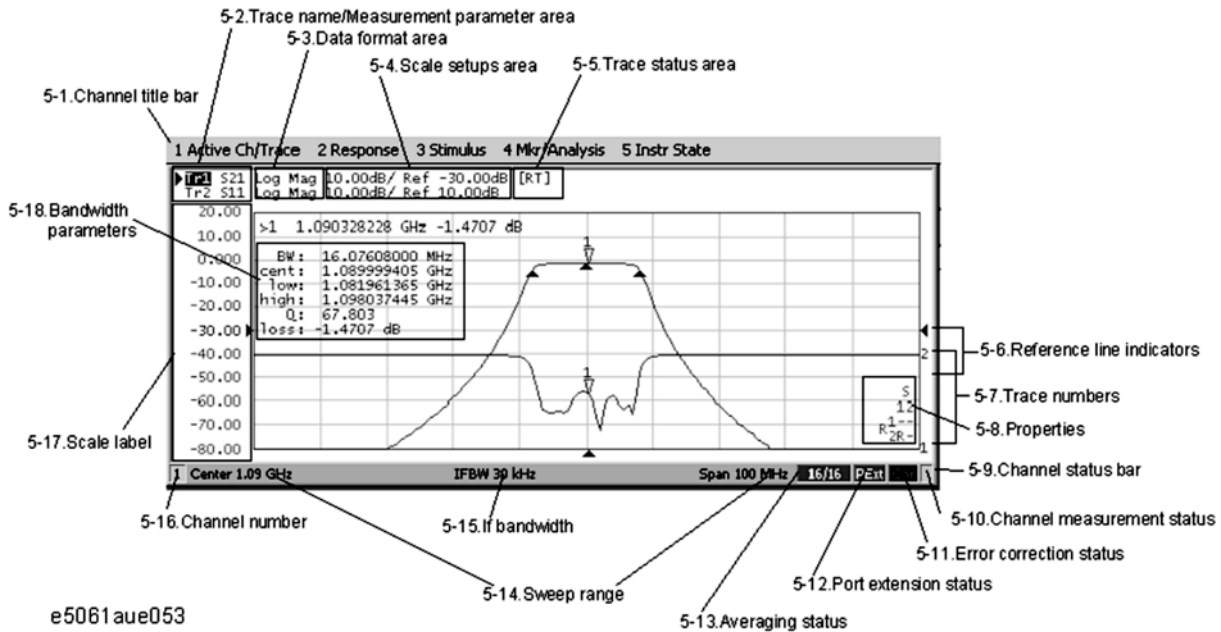

e5061aue053

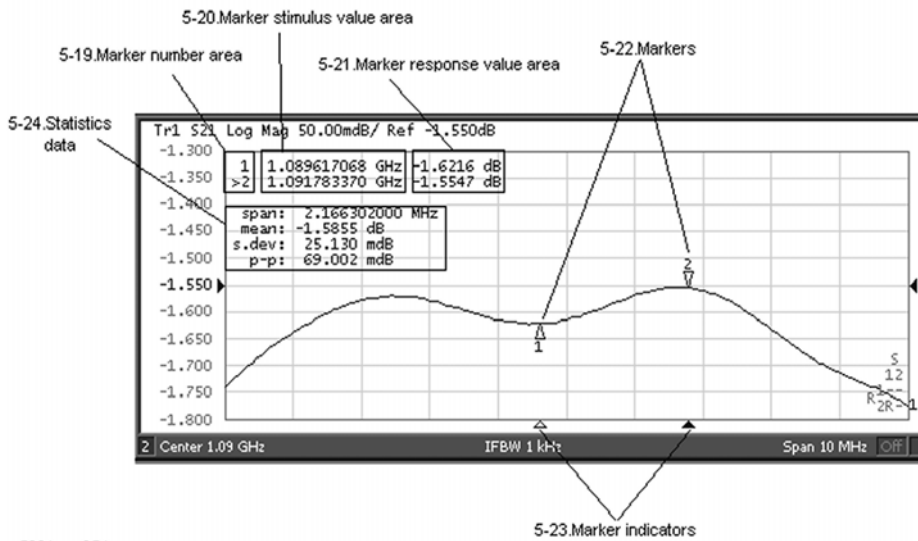



e5061aue054

### 5-1. Channel Title Bar

You can assign a title to each channel and have the title displayed on the bar. For more about setting up a channel title bar, see “Labeling a Window” on page 76.

### 5-2. Trace Name/Measurement Parameter

The names of the traces (Tr1 through Tr9) on the channel and their measurement parameters are displayed here. ► to the right of the trace name indicates the active trace (the trace for which setup is being performed). To make a trace active, use **Trace Next** or **Trace Prev**. Clicking the line where the trace name is placed (the mouse pointer changes from  to ) also makes a trace active.

### 5-3. Data Format

The data format of each trace is displayed here. For more on setting up data formats, see “Selecting a Data Format” on page 66.

### 5-4. Scale Settings

The scale setting for each trace is displayed here. This example shows that “0.00dB/” corresponds to 10 dB per division. “Ref 0.000dB” shows that the value of the reference line is at 0 dB. For more about setting scales, see “Setting the Scales” on page 70.



**5-5. Trace Status Area**

The setup for each trace is displayed here.

**Table 2-1 Trace Status Display**

| Classification        | Contents inside the [ ]  | Meaning  |
|-----------------------|--|--|
| Error correction      | <b>RO</b><br><b>RS</b><br><b>RT</b><br><b>ER</b><br><b>F1</b><br><b>F2</b>                           | Error correction: ON (OPEN (n) response calibration)<br>Error correction: ON (SHORT (n) response calibration)<br>Error correction: ON (THRU (n) response calibration)<br>Error correction: ON (Enhanced response calibration)<br>Error correction: ON (1-port calibration)<br>Error correction: ON (Full 2-port calibration) |
| Turning on/off traces | Nothing<br><b>M</b><br><b>D&amp;M</b><br><b>off</b>  | Data trace: ON, Memory trace: OFF<br>Data trace: OFF, Memory trace: ON<br>Data trace: ON, Memory trace: ON<br>Data trace: OFF, Memory trace: OFF   |
| Performing data math  | <b>D+M (D+M&amp;M)</b><br><b>D-M (D-M&amp;M)</b><br><b>D*M (D*M&amp;M)</b><br><b>D/M (D/M&amp;M)</b> | Execution of Data+Mem math<br>Execution of Data-Mem math<br>Execution of Data*Mem math<br>Execution of Data/Mem math   |
| Electrical delay      | <b>Del</b>   | A numeric value other than 0 (zero) is specified as the electrical delay or phase offset.  |
| Smoothing             | <b>Smo</b>   | Smoothing: ON  |
| Gating                | <b>Gat</b>   | Gating: ON   |
| Parameter conversion  | <b>Zr</b><br><b>Zt</b><br><b>Yr</b><br><b>Yt</b><br><b>1/S</b>                                       | Conversion: ON (Impedance: Reflection measurement)<br>Conversion: ON (Impedance: Transmission measurement)<br>Conversion: ON (Admittance: Reflection measurement)<br>Conversion: ON (Admittance: Transmission measurement)<br>Conversion: ON (Inverse S-parameter)   |

**5-6. Reference Line Indicators**

The indicators that indicate the position of the reference line for the Y-axis scale in the rectangular display format. One indicator to the right and the other to the left of the scale. (▶ and ◀). To enter a numeric value for the position of the reference line, open the data entry bar using keys: **[Scale]** - **Reference Position**. You can also move the position of the reference line by placing the mouse pointer on either of the two reference line indicators (the pointer changes from  to .), moving the indicator vertically with the left mouse button kept pressed, and then releasing the button at the desired location. (This mouse operation is called a drag-and-drop operation).

**5-7. Trace Number**

In the rectangular display format, the trace number is displayed in the same color as the trace at the right end of each trace.

### 5-8. Properties

Displays the status of the obtained calibration coefficients on the channel. For details, see “Acquisition status of calibration coefficient for each channel” on page 87.

### 5-9. Channel Status Bar

The status of each channel is displayed here. (See parts 5-10 through 5-16.)

### 5-10. Channel Measurement Status

Displays the update status of traces on the channel.

|              |   |
|--------------|---|
| !            | Measurement in progress. When the sweep time exceeds 1.5 seconds, ↑ is displayed at the point on the trace.   |
| #            | Invalid traces. The measurement conditions have changed, but the traces on the channel currently displayed have not been updated to match the new conditions. |
| (No display) | The measurement has not executed.   |

### 5-11. Error Correction Status

Displays the execution status of error correction on the channel. For details, see “Execution status of error correction for each channel” on page 86.

### 5-12. Port Extension Status

Shows whether the port extension is turned ON or OFF.

|                                 |                     |
|---------------------------------|---------------------|
| <b>PExt</b> (displayed in blue) | Port extension: ON  |
| (not displayed)                 | Port extension: OFF |

### 5-13. Averaging Status

Displays the averaging factor and averaging count when averaging is turned on.

|                                |  |
|--------------------------------|--|
| <b>n/m</b> (displayed in blue) | Averaging: ON<br>(m: averaging factor; n: averaging count) |
| (not displayed)                | Averaging: OFF   |

### 5-14. Sweep Range

Indicates the sweep range by using the start/stop or center/span.

### 5-15. IF Bandwidth/CW Frequency

Indicates the IF bandwidth when the sweep type is linear/log frequency or the CW frequency when the sweep type is power.

### 5-16. Channel Number

Indicates the channel number.

### 5-17. Graticule Labels

Y-axis divisions in the rectangular display format. When traces in the rectangular display format are overlaid, the Y-axis divisions for the active trace are displayed. The value of the reference line (the division line between ► and ◀) is entered numerically by opening the data entry bar using the keys: **Scale** + **Reference Value**. You can change values of the reference line at one division intervals by placing the mouse pointer in the area of the graticule label (the pointer changes from ↖ to ↕), moving the pointer vertically with the left mouse button pressed, and then releasing the button at the desired location.

### 5-18. Bandwidth Parameters

Turning on the bandwidth search function displays the bandwidth parameters here. For more about the bandwidth search function, see “Determining the Bandwidth of the Trace (Bandwidth Search)” on page 146.

### 5-19. Marker Numbers

The marker values are displayed in a list at positions 5-21, 5-22, and 5-23. Position 5-21 displays the marker numbers. For the active marker (the one for which setup and analysis are being performed), > is displayed to the left of the marker number. For the reference marker, △ is displayed instead of the marker number.

### 5-20. Marker Stimulus Values

The marker stimulus value for each marker (the frequency/power level at the marker point) is displayed here.

### 5-21. Marker Response Values

The marker response value for each marker (the measurement value at the marker point) is displayed here. Two (or three) response values are displayed for data in Smith chart or polar display format.

### 5-22. Markers

The markers used for reading values on a trace. Up to 10 markers can be displayed for each trace.

 Active marker (the one for which setup and analysis are being performed)

 Non-active marker



n denotes a marker number. For the reference marker, however, nothing is displayed at the location of n. Clicking the marker or one of the “5-23. Marker Indicators” makes the marker active.

### 5-23. Marker Indicators

Indicates the positions of markers on the stimulus axis.

 Active marker indicator

 Non-active marker indicator

You can also move a marker to the desired position by placing the mouse pointer on the marker indicator or position of the marker itself (the pointer changes from  to ) , moving the indicator vertically with the left mouse button pressed, and then releasing the button at the desired location.

### 5-24. Statistics Data

Turning on the statistics data function displays statistics data here. For more about the statistics data function, see “Determining the Mean, Standard Deviation, and p-p of the Trace” on page 150.

## Rear Panel: Names and Functions of Parts

This section describes the names and functions of the parts on the rear panel of the E5061A/E5062A.

Figure 2-7 Rear Panel

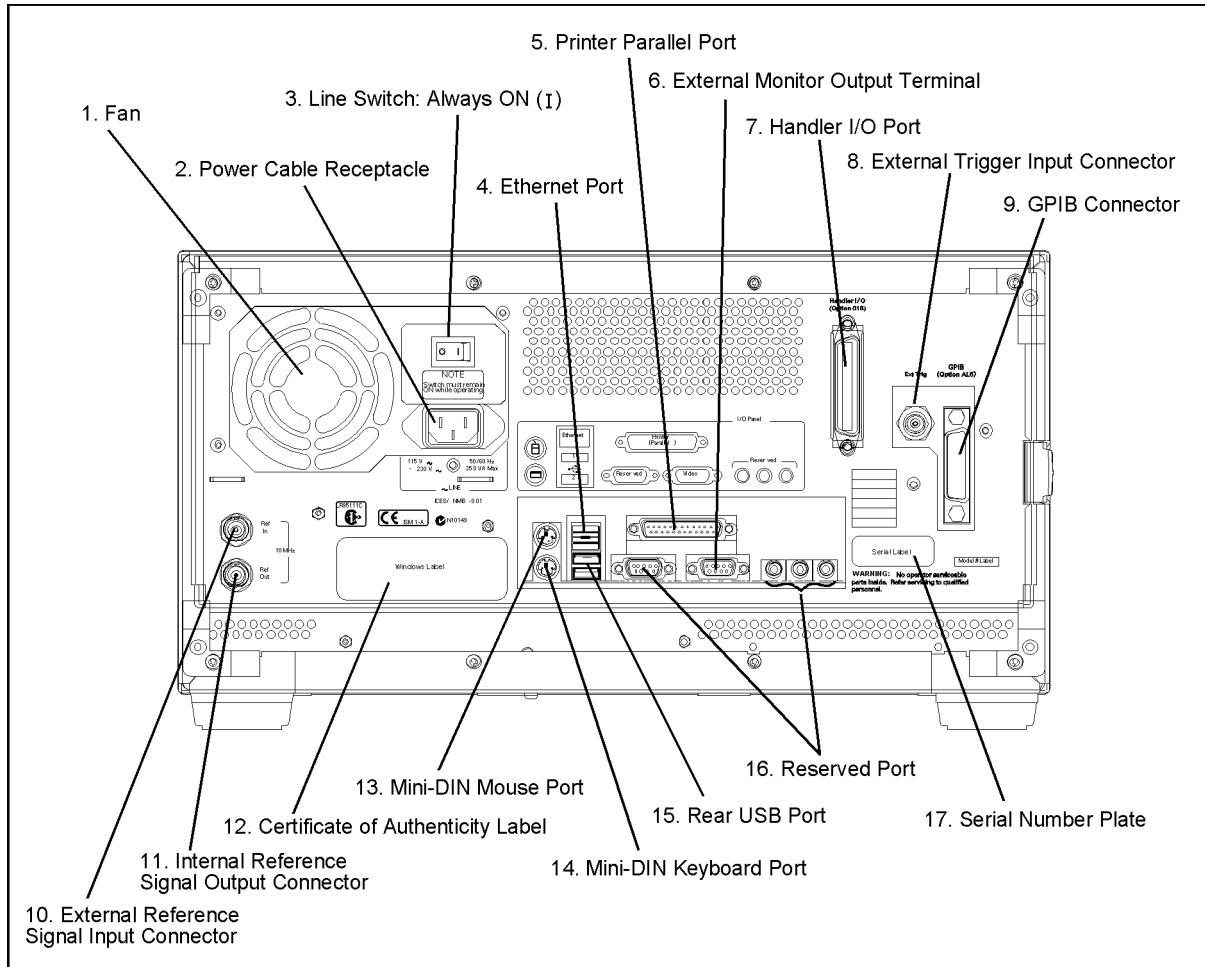

e5061aue021



## 1. Fan

The cooling fan for limiting the temperature rise inside the E5061A/E5062A. This fan exhausts heated air from inside the analyzer to the outside.

## 2. Power Cable Receptacle (to LINE)

The receptacle (outlet) to which the power cable is connected.

---

### NOTE

To feed power, use the included three-prong power cable with a ground conductor.

The plug attached to the power cable (on the power outlet side or device side of the cable) serves as the disconnecting device (device that cuts off power supply) of the E5061A/E5062A. When the power supply must be cut off to avoid danger of electric shock or the like, pull out the power cable plug (on the power outlet side or device side of the cable). For the procedure for turning off the mains in normal use, see the description in “1. Standby Switch” on page 21.

For more about the power supply, see Chapter 2 “Installation” in the Installation and Quick Start Guide.

## 3. Line Switch (Always ON)

Always keep this switch on (I).

---

### CAUTION

**Do not use this switch to turn off (O) the mains. Doing so may cause the analyzer to fail.** For more information, see the description of the “1. Standby Switch” on page 21.

## 4. Ethernet Port

A terminal for connecting the E5061A/E5062A to a LAN (Local Area Network). Connecting this instrument to a LAN enables you to access the hard disk drive of this instrument from an external PC or to control this instrument by using SICL-LAN or telnet.

Connector type: 8-pin RJ-45 connector

Base standard: 10Base-T/100Base-TX Ethernet (automatic data rate selection)

## 5. Printer Parallel Port

The 25-pin parallel port for printer connection. Connecting a designated printer to this port allows screen information on the E5061A/E5062A to be printed to a printer. For more about printing to a printer, see “Printing Displayed Screen” on page 174.

## 6. External Monitor Output Terminal (Video)

A terminal to which the external color monitor (display device) is connected. By connecting the color monitor to this terminal, the same information shown on the LCD screen of the main body can be displayed on an external color monitor.

---

### NOTE

An external monitor needs to be connected to the analyzer and turned on before the analyzer is turned on so that the analyzer recognizes the monitor properly.

Connector type: 15-pin VGA connector, female

## 7. Handler I/O Port

The terminal to which an automatic machine (handler) used on a production line is connected. For more about using the handler I/O port, see the Programmer's Guide.

Connector type: 36-pin D-sub connector

## 8. External Trigger Input Connector (Ext Trig)

A connector to which external trigger signals are input. This connector detects the downward transition from the HIGH state in TTL signals as the trigger signal. To use this connector to generate a trigger, you must set the trigger source to the "external" side. (Key operation: **Trigger** - **Trigger Source** - **External**).

Connector type: BNC connector, female

## 9. GPIB Connector

General Purpose Interface Bus (GPIB). The connection of an external controller and other devices through this connector allows an automatic measurement system to be structured. For more about the automatic measurement system using the GPIB, see the Programmer's Guide.

## 10. External Reference Signal Input Connector (Ref In)

The reference signal input connector for phase-locking the measurement signal from the E5061A/E5062A to the external frequency reference signal. Inputting the reference signal to this connector improves the accuracy and stability of the frequency of the measurement signal from the E5061A/E5062A.

Connector type: BNC connector, female

Input signal (Nominal): 10 MHz  $\pm$ 10 ppm, 0 dBm  $\pm$  3 dB

---

### NOTE

When the frequency reference signal is input to this connector, the measurement signal from the E5061A/E5062A is automatically phase-locked to the reference signal. When an input signal is not present, the frequency reference signal inside the E5061A/E5062A is automatically used. The **ExtRef** on the instrument status bar is displayed in blue when the system is phase-locked to the external reference signal and in gray when not phase-locked.

---

## 11. Internal Reference Signal Output Connector (Ref Out)

A connector for outputting the internal frequency reference signal from the E5061A/E5062A. By connecting this output connector to the external reference signal input connector of another device, the device can be phase-locked to the internal reference signal of the E5061A/E5062A and used under this condition.

Connector type: BNC connector, female

Output signal (Nominal): 10 MHz, 0 dBm  $\pm$  3 dB

Output impedance (Nominal): 50  $\Omega$

## 12. Certificate of Authenticity Label

The label showing information of the “Certificate of Authenticity.”

## 13. Mini-DIN Mouse Port

The port to which a mini-DIN type mouse is connected. Using a mouse enables you to more efficiently perform the operations of menu bars, softkeys, and dialog boxes as well as selecting an active channel or an active trace. The mouse also enables you to move a marker or the scale reference line using drag-and-drop operations.

---

**NOTE**

Be sure to only use a mouse designated for use with this instrument. Using a mouse other than those designated may cause wrong actions to occur.

## 14. Mini-DIN Keyboard Port

The port to which a mini-DIN type keyboard is connected. The keyboard can be used to edit VBA programs inside the E5061A/E5062A or to enter file names. Since the arrow keys and numeric keys on the keyboard work in the same way as the arrow keys and numeric keys on the front panel of the E5061A/E5062A, you can use it instead of the front panel operation.

---

**NOTE**

Be sure to only use a keyboard designated for use with this instrument. Using a keyboard other than those designated may cause wrong actions to occur.

## 15. Rear USB port

A USB (Universal Serial Bus) port (number of ports: 2) specifically for an ECal (Electronic Calibration), a USB/GPIB interface, or a printer. The specifications of this port are identical to the “12. Front USB Port” on page 29.

## 16. Reserved Port (Reserved)

Using these two ports is not allowed. No connections.

## 17. Serial Number Plate

The seal showing the serial number of the product.

Overview of Functions

**Rear Panel: Names and Functions of Parts**

---

## 3 Setting Measurement Conditions

This chapter describes how to set up the measurement conditions for the Agilent E5061A/E5062A Network Analyzer.

---

## Initializing Settings

The E5061A/E5062A has three different initial settings as shown in Table 3-1 below.

**Table 3-1**

**E5061A/E5062A Initial Settings and Methods for Restoring Them**

| Initial Setting         | Restore Method  |
|-------------------------|---|
| Preset setting          | <ul style="list-style-type: none"><li>• Press <b>Preset</b> - <b>OK</b> on the front panel*<sup>1</sup></li></ul> or, <ul style="list-style-type: none"><li>• Execute the :SYST:PRES command.</li></ul> |
| *RST setting            | Execute the *RST command.   |
| Factory default setting | (The way the E5061A/E5062A is set up prior to shipment from the factory)  |

\*1. Initialization may be executed without displaying the **OK** or **Cancel** button, depending on the instrument setting state. For more information, see “Showing/hiding the confirmation buttons when presetting” on page 234.

The user can set items to be preset freely. For more information, see “Setting the user preset function” on page 234.

For further details of each setting, refer to Appendix , “List of Default Values, Save/Recall Settings, and Backup Settings,” on page 314. To restore initial settings using commands, refer to the Programmer’s Guide and VBA Programmer’s Guide.

---

## Setting Channels and Traces

The E5061A/E5062A allows you to use up to 4 channels to perform measurement under 4 different stimulus conditions.

For each channel, up to 4 traces (measurement parameters) can be displayed. Because multiple traces can be displayed for each channel, the feature to link the stimulus conditions between channels is not provided and each channel is always independent of one another. In other words, for the E5061A/E5062A, you need to set the measurement conditions and execute calibration for all channels you use for measurement.

When you set items whose setting target is channels/traces (refer to “Setting target for each setting item (range to which setting affects)” on page 54), the target is the selected (active) channel/trace. You can specify only the displayed channels/traces as active channels/traces. Therefore, set the display of channels/traces before setting the measurement conditions.

### Setting channel display (layout of channel windows)

The measurement result for each channel is displayed in its dedicated window (channel window). You cannot have a single window display the measurement results from more than one channel. This means that setting the window layout determines the number of channels displayed on screen.

---

#### NOTE

The execution of measurement for each channel does not depend on how the channel is displayed (channels that are not displayed can be measured). For information on the measurement execution for each channel (trigger mode and trigger source), refer to Chapter 5, “Making Measurements,” on page 119.

The setting procedure of the window layout is as follows:

- Step 1.** Press **Display**.
- Step 2.** Press **Allocate Channels**.
- Step 3.** Press the desired softkey to select the window layout (refer to Figure 3-1).

Figure 3-1

Layout of channel windows

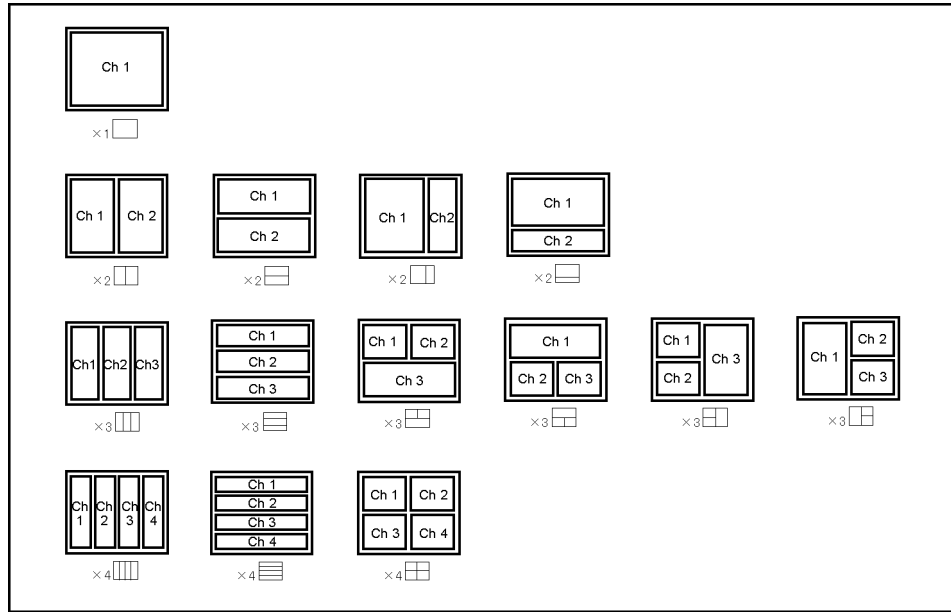

e5061auj001



## Setting trace display

### Setting number of traces

Depending on the measurement parameters of the traces displayed for each channel, a sweep necessary for each channel is executed. For more information, refer to “Sweep Order in Each Channel” on page 120.

You specify the trace display with the number of traces (upper limit of displayed trace numbers). For example, if you set the number of traces to 3, trace 1 to trace 3 are displayed.

The setting procedure of the number of traces is as follows:

- Step 1.** Press **Channel Next** or **Channel Prev** to select the channel for which you want to set the number of traces.
- Step 2.** Press **Display**.
- Step 3.** Press **Number of Traces**.
- Step 4.** Press the desired softkey to set the number of traces.

### Setting trace layout (graph layout)

Traces are laid out and displayed in the order of the trace number from graph 1 according to the graph layout in the channel window.

You can select the graph layout from Figure 3-2.

If the number of traces is less than the number of graphs, nothing is displayed in the remaining area. If the number of traces you set exceeds the number of graphs, excess traces are superimposed from the first graph. For example, if you select **x3** as the graph layout and set the number of traces to 4, graph 1 (Gr1 in Figure 3-2) displays traces 1 and 4 by superimposing, and graph 2 (Gr2 in Figure 3-2) and graph 3 (Gr3 in Figure 3-2) display trace 2 and 3 respectively as shown in the figure below.

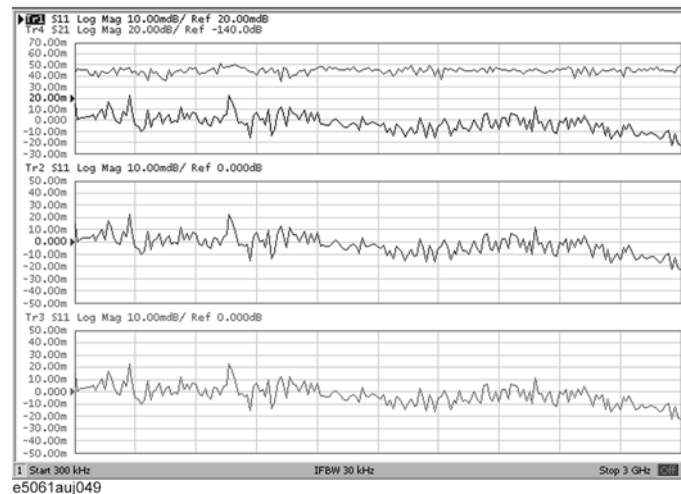

## Setting Measurement Conditions Setting Channels and Traces

The setting procedure of the graph layout is as follows:

- Step 1.** Press **Channel Next** or **Channel Prev** to select the channel for which you want to set the graph layout.
- Step 2.** Press **Display**.
- Step 3.** Press **Allocate Traces**.
- Step 4.** Press the desired softkey to select the graph layout (refer to Figure 3-2).

Figure 3-2

### Graph layout

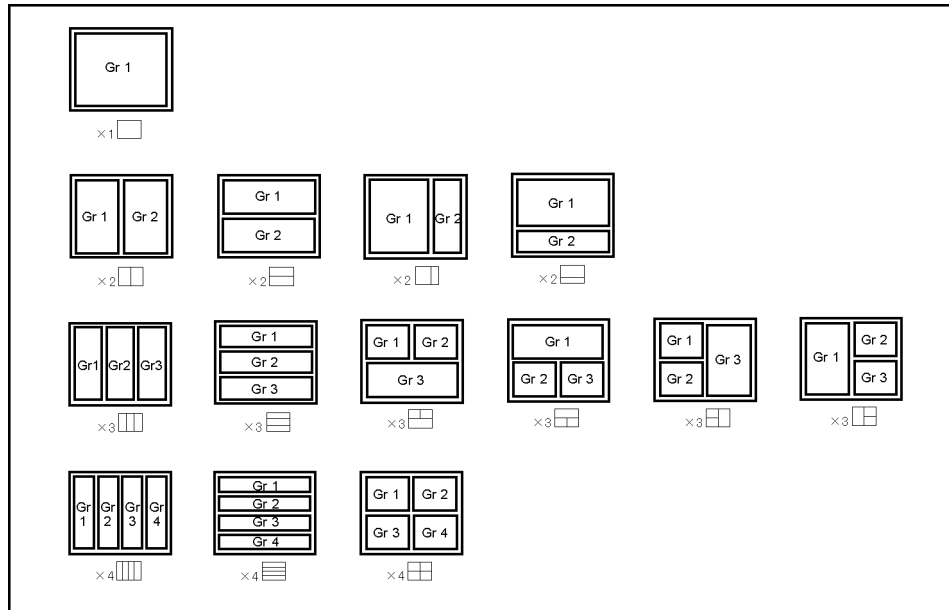

## Active channel

The channel whose setting is to be changed is called an active channel. The window frame for the active channel is displayed brighter than window frames for other channels. To change the setting specific to a certain channel, first activate the channel.

To change the active channel, use the following hardkeys:

| Hardkey             | Function   |
|---------------------|--|
| <b>Channel Next</b> | Change the active channel to the next channel with the larger channel number.  |
| <b>Channel Prev</b> | Change the active channel to the next channel with the smaller channel number. |

## Active trace

The trace whose setting is to be changed is called an active trace. The trace name on the screen (for example, Tr3) of the current active trace is highlighted and indicated with ► to the left. To change the setting specific to a certain trace, first activate the trace.

To select the active trace, use the following hardkeys:

| Hardkey           | Function   |
|-------------------|--|
| <b>Trace Next</b> | Change the active trace to the next trace with the larger trace number.  |
| <b>Trace Prev</b> | Change the active trace to the next trace with the smaller trace number. |

Setting Measurement Conditions  
Setting Channels and Traces

Setting target for each setting item (range to which setting affects)

Table 3-2 describes the setup items (analyzer, channel, or trace) and the effect that each parameter has on them.

**Table 3-2 Parameters and Setup Items (Controlled Items)**

| Parameter  | Setup Items (Controlled Items) |         |       | Setup Key(s)   |
|--|--------------------------------|---------|-------|--|
|  | Analyzer                       | Channel | Trace |  |
| <b>Stimulus Settings</b>   |                                |         |       |  |
| Sweep range  |                                | √       |       | <input type="button" value="Start"/> <input type="button" value="Stop"/> <input type="button" value="Center"/> <input type="button" value="Span"/> |
| Power, CW frequency  |                                | √       |       | <input type="button" value="Sweep Setup"/> - Power   |
| Sweep time/Sweep delay time  |                                | √       |       | <input type="button" value="Sweep Setup"/> - Sweep Time/Sweep Delay  |
| Number of points   |                                | √       |       | <input type="button" value="Sweep Setup"/> - Points  |
| Segment sweep  |                                | √       |       | <input type="button" value="Sweep Setup"/> - Sweep Type<br>/Edit Segment Table/Segment Display   |
| <b>Trigger Settings</b>  |                                |         |       |  |
| Trigger source   | √                              |         |       | <input type="button" value="Trigger"/> - Trigger Source/Restart/Trigger  |
| Trigger mode   |                                | √(*1)   |       | <input type="button" value="Trigger"/> - Hold/Hold All Channels /Single<br>/Continuous/Continuous Disp Channels                                    |
| <b>Response Settings</b>   |                                |         |       |  |
| Measurement parameter  |                                |         | √     | <input type="button" value="Meas"/>  |
| Data format  |                                |         | √     | <input type="button" value="Format"/>  |
| Scale, Electrical delay, Phase offset                                    |                                |         | √(*2) | <input type="button" value="Scale"/>   |
| Memory trace and data math   |                                |         | √     | <input type="button" value="Display"/> - Display /Data → Mem /Data Math  |
| Window title   |                                | √       |       | <input type="button" value="Display"/> - Edit Title Label<br>/Title Label (ON/OFF)   |
| ON/OFF for the graticule label display in the rectangular display format |                                | √       |       | <input type="button" value="Display"/> - Graticule Label (ON/OFF)  |
| Graticule label format in the rectangular display format                 |                                | √       |       | <input type="button" value="Display"/> - Graticule Label (Auto/Relative)   |
| Color inversion  | √                              |         |       | <input type="button" value="Display"/> - Invert Color  |
| Frequency display ON/OFF   | √                              |         |       | <input type="button" value="Display"/> - Frequency (ON/OFF)  |
| Display update ON/OFF  | √                              |         |       | <input type="button" value="Display"/> - Update (ON/OFF)   |
| Averaging  |                                | √       |       | <input type="button" value="Avg"/> - Averaging Restart<br>/Avg Factor/Averaging (ON/OFF)   |
| Smoothing  |                                |         | √     | <input type="button" value="Avg"/> - Smo Aperture<br>/Smoothing (ON/OFF)   |

**Table 3-2 Parameters and Setup Items (Controlled Items)**

| Parameter  | Setup Items (Controlled Items) |         |       | Setup Key(s)   |
|--|--------------------------------|---------|-------|--|
|  | Analyzer                       | Channel | Trace |  |
| IF bandwidth   |                                | ✓       |       | <input type="button" value="Avg"/> - IF Bandwidth  |
| Calibration  |                                | ✓       |       | <input type="button" value="Cal"/>   |
| Marker   |                                |         | ✓(*3) | <input type="button" value="Marker"/> <input type="button" value="Marker Search"/> <input type="button" value="Marker Fctn"/>  |
| <b>Analysis</b>  |                                |         |       |  |
| Fault Location   |                                |         | ✓     | <input type="button" value="Analysis"/> - Fault Location   |
| Parameter conversion   |                                |         | ✓     | <input type="button" value="Analysis"/> - Conversion   |
| Limit test   |                                |         | ✓     | <input type="button" value="Analysis"/> - Limit Test   |
| Saving and recalling data  | ✓                              |         |       | <input type="button" value="Save/Recall"/>   |
| Macro  | ✓                              |         |       | <input type="button" value="Macro Setup"/> <input type="button" value="Macro Run"/> <input type="button" value="Macro Break"/> |
| <b>System</b>  |                                |         |       |  |
| Printing/Saving display screen/Beeper/GRIB settings/Network settings/Date & Time/Key lock/Backlight/Firmware revision/Service menu | ✓                              |         |       | <input type="button" value="System"/>  |
| Preset   | ✓                              |         |       | <input type="button" value="Preset"/>  |

\*1. **Hold All Channels** for the analyzer.

\*2. **Auto Scale All** and scale **Divisions** must be set up in rectangular form for each channel.

\*3. Turning the marker table display on or off applies to the entire analyzer. On the other hand, the sweep range setting of the marker must be performed for each channel. In the preset conditions, marker coupling is enabled and marker settings and movements are effective for all traces on a channel.

## **Setting the System Z0**

The procedure to set the system characteristic impedance ( $Z_0$ ) is as follows:

- Step 1.** Press .
- Step 2.** Press **Set Z0**.
- Step 3.** Enter the system  $Z_0$  using the ENTRY block keys on the front panel.

## Setting Stimulus Conditions

You can set the stimulus condition for each channel independently.

### Setting sweep type

You can select the sweep type from the following 4 types.

| Sweep type | Description  |
|------------|--|
| Linear     | Sweeps frequencies in linear scale.  |
| Log        | Sweeps frequencies in logarithmic scale.   |
| Segment    | Performs a sweep with linear sweep conditions (segments) combined. For more information, refer to “Performing a Segment-by-Segment Sweep (Segment Sweep)” on page 201. |
| Power      | Sweeps power levels in linear scale.   |

The procedure to select the sweep type is as follows:

- Step 1.** Press **Channel Next** or **Channel Prev** to select the channel for which you want to set the sweep type.
- Step 2.** Press **Sweep Setup**.
- Step 3.** Press **Sweep Type**.
- Step 4.** Press the desired softkey to select the sweep type.

### Setting the Sweep Range

There are two ways to set the sweep range: by specifying the lowest and the highest values and by specifying the center value and a span. Once the sweep range is set, it is possible to change the range by substituting the lowest value, the highest value, or the center value with a value (stimulus value) represented by a marker on the trace.

Figure 3-3

#### Setting the Sweep Range

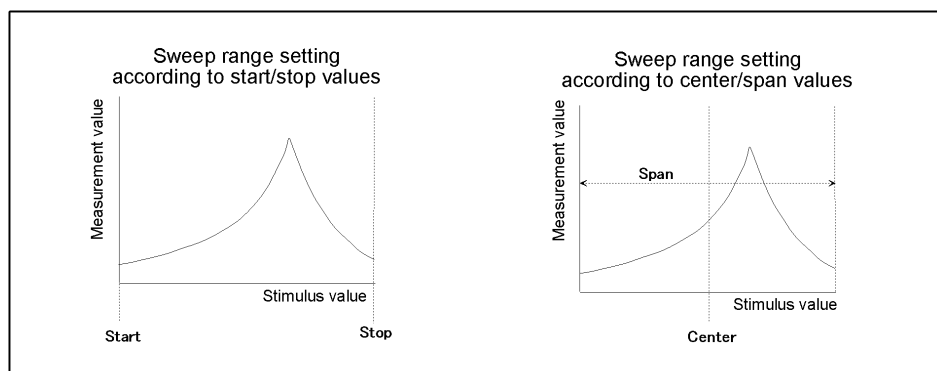

e5070bue001

## Setting Measurement Conditions

### Setting Stimulus Conditions

#### Setting the Sweep Range with the Lowest and Highest Values

- Step 1.** Press **Channel Next** or **Channel Prev** to select the channel for which the sweep range will be set.
- Step 2.** Press **Start**.
- Step 3.** Using the ENTRY block keys on the front panel, input the lowest value.
- Step 4.** Press **Stop**.
- Step 5.** Using the ENTRY block keys on the front panel, input the highest value.

#### Setting the Sweep Range with the Center Value and a Span

- Step 1.** Press **Channel Next** or **Channel Prev** to select the channel for which the sweep range will be set.
- Step 2.** Press **Center**.
- Step 3.** Using the ENTRY block keys on the front panel, input the center value.
- Step 4.** Press **Span**.
- Step 5.** Using the ENTRY block keys on the front panel, input a span value.

#### Setting the Sweep Range Using the Marker

- Step 1.** In the channel window whose range must be set, place the active marker on the active trace to a position that corresponds to the new range (to the lowest, highest, or center value).
- Step 2.** Press **Marker Fctn**.
- Step 3.** Press the softkey that corresponds to each value.

| Softkey                | Function   |
|------------------------|--|
| <b>Marker → Start</b>  | Sets the lowest value to the stimulus value of the active marker on the currently active trace.  |
| <b>Marker → Stop</b>   | Sets the highest value to the stimulus value of the active marker on the currently active trace. |
| <b>Marker → Center</b> | Sets the center value to the stimulus value of the active marker on the currently active trace.  |

---

#### NOTE

If the reference marker is on and the stimulus value of the active marker is expressed by a value relative to the reference marker, the absolute stimulus value will be used to set the new sweep range.

---



Figure 3-4 Setting the Sweep Range Using the Marker

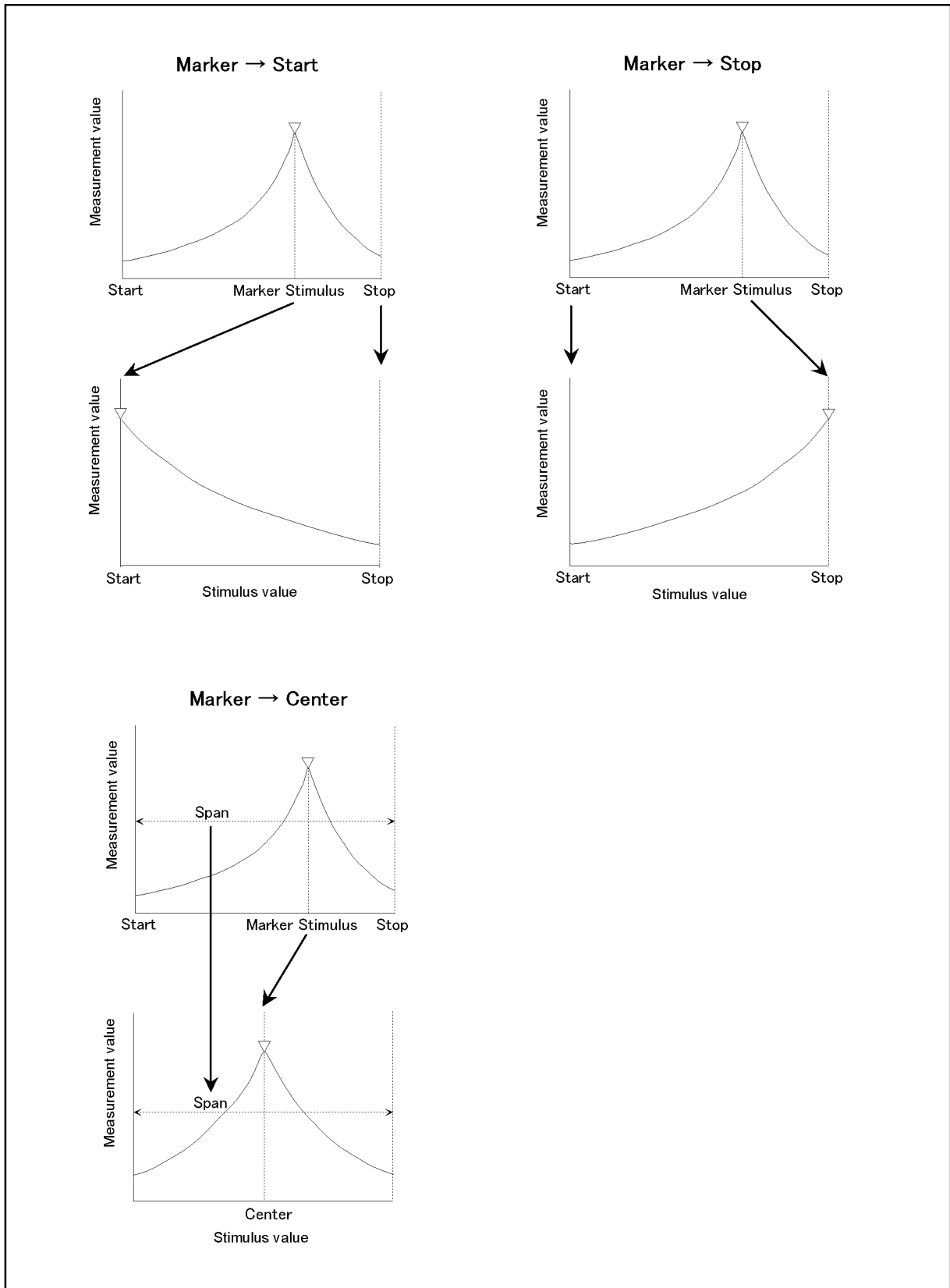

e5070aue118

## On/off of stimulus signal output

You can turn on/off the stimulus signal output.

When you turn off the stimulus signal output, you cannot perform measurement and therefore you do not need to turn it off usually. This is mainly used to turn the output back to on when the output has been turned off due to the power trip feature.

Follow these steps to turn it on/off:

- Step 1.** Press **Sweep Setup**.
- Step 2.** Press **Power**.
- Step 3.** Press **RF Out**. Each press toggles between on/off.

When set to off, “RF OFF” is displayed in “4. Instrument Status Bar” on page 34.

### Power trip

The power trip is a feature that the instrument automatically turns off the output of the stimulus signal to protect the instrument when a signal whose level exceeds the upper limit is inputted to the test port.

If the power output is automatically turned off due to the power trip feature, remove the cause of the overinput and turn on the power output according to the above steps to restart the measurement.

## Setting fixed frequency at power sweep

The setting procedure of the fixed frequency (CW frequency) at the power sweep is as follows:

- Step 1.** Press **Channel Next** or **Channel Prev** to select the channel for which you want to set the fixed frequency.
- Step 2.** Press **Sweep Setup**.
- Step 3.** Press **Power**.
- Step 4.** Press **CW Freq**.
- Step 5.** Enter the fixed frequency using the ENTRY block keys on the front panel.

## Setting power level at frequency sweep

You can set the power level at the frequency sweep independently for each test port, within the range of  $-5$  dBm to 10 dBm (for the instrument with option 250, 275, or 1E1, the range of  $-45$  dBm to 10 dBm) and in resolution of 0.05 dB.

### Selecting range

When option 1E1 is installed, you can select from the following power ranges.

| Selectable power range |
|------------------------|
| $-5$ dBm to 10 dBm     |
| $-15$ dBm to 0 dBm     |
| $-25$ dBm to $-10$ dBm |
| $-35$ dBm to $-20$ dBm |
| $-45$ dBm to $-30$ dBm |

#### NOTE

The range selection is common to all ports. You cannot select it for each port independently.

The selection procedure of the range is as follows:

- Step 1.** Press **Channel Next** or **Channel Prev** to select the channel for which you want to set the power range.
- Step 2.** Press **Sweep Setup**.
- Step 3.** Press **Power**.
- Step 4.** Press **Power Ranges**.
- Step 5.** Press the desired softkey to select the power range.

### Setting the level

- Step 1.** Press **Channel Next** or **Channel Prev** to select the channel for which you want to set the power level.
- Step 2.** Press **Sweep Setup**.
- Step 3.** Press **Power**.
- Step 4.** Press **Port Couple** and select the on/off of the level coupling for all ports.

|            |   |
|------------|---|
| <b>ON</b>  | The same power level is outputted to all ports.                 |
| <b>OFF</b> | A specific power level is outputted to each port independently. |

#### NOTE

The power level of port 1 is coupled with the power level for all ports.

#### NOTE

If you change the on/off of the level coupling, all ports are automatically changed to the same level value as that of port 1.

## Setting Measurement Conditions

### Setting Stimulus Conditions

#### Step 5. When setting level for all ports (Port Couple ON)

1. Press **Power**.
2. Enter the power level using the ENTRY block keys on the front panel.

#### When setting level for each port (Port Couple OFF)

1. Press **Port Power**.
2. Press the softkey corresponding to each port (**Port 1 Power** to **Port 2 Power**).
3. Enter the power level using the ENTRY block keys on the front panel.

#### Correcting attenuation of power level (using power slope feature)

You can use the power slope feature to correct the attenuation of a power level simply proportional to the frequency (attenuation due to cables and so on), which improves the accuracy of the level applied to the DUT actually.

#### On/off of power slope feature

**Step 1.** Press **Channel Next** or **Channel Prev** to select the channel for which power slope feature will be turned on or off.

**Step 2.** Press **Sweep Setup**.

**Step 3.** Press **Power**.

**Step 4.** Press **Slope [OFF]** (**Slope [ON]**). Each press toggles between on/off.

#### Setting correction coefficient (correction amount for 1 GHz)

**Step 1.** Press **Channel Next** or **Channel Prev** to select the channel for which you want to set the correction coefficient.

**Step 2.** Press **Sweep Setup**.

**Step 3.** Press **Power**.

**Step 4.** Press **Slope [xxx dB/GHz]**. "xxx" represents the current set value.

**Step 5.** Enter the correction coefficient using the ENTRY block keys on the front panel.

## Setting the Number of Points

The number of points is the number of data items collected in one sweep. It can be set to any number from 2 to 1601 for each channel independently.

- To obtain a higher trace resolution against the stimulus value, choose a larger number of points.
- To obtain higher throughput, keep the number of points to a smaller value within an allowable trace resolution.
- To obtain higher measurement accuracy after calibration, perform calibration using the same number of points as in actual measurements.

### Setting the Number of Points

- Step 1.** Press **Channel Next** or **Channel Prev** to select the channel for which the number of points will be set.
- Step 2.** Press **Sweep Setup**.
- Step 3.** Press **Points**.
- Step 4.** Using the ENTRY block keys on the front panel, input the desired number of points.

## Setting the Sweep Time

Sweep time is the time it takes to complete a sweep for each stimulus (source) port. Two modes are available for setting the sweep time: manual sweep time mode and automatic sweep time mode.

### Manual Sweep Time Mode

In this mode, the sweep time is set manually. Once the sweep time is set, changes in measurement conditions will not affect the sweep time as long as it is within the analyzer's capability. If the sweep time becomes lower than the analyzer's lower sweep time limit, the sweep time will be reset to the shortest time within the conditions. If the sweep time exceeds the analyzer's upper sweep time limit, the sweep time will be reset to the longest time within the conditions.

### Automatic Sweep Time Mode

The sweep time is always kept to the shortest time possible with the current measurement conditions.

Figure 3-5 shows the definitions of the sweep time and the sweep delay time.

Figure 3-5 Sweep Time and Sweep Delay Time

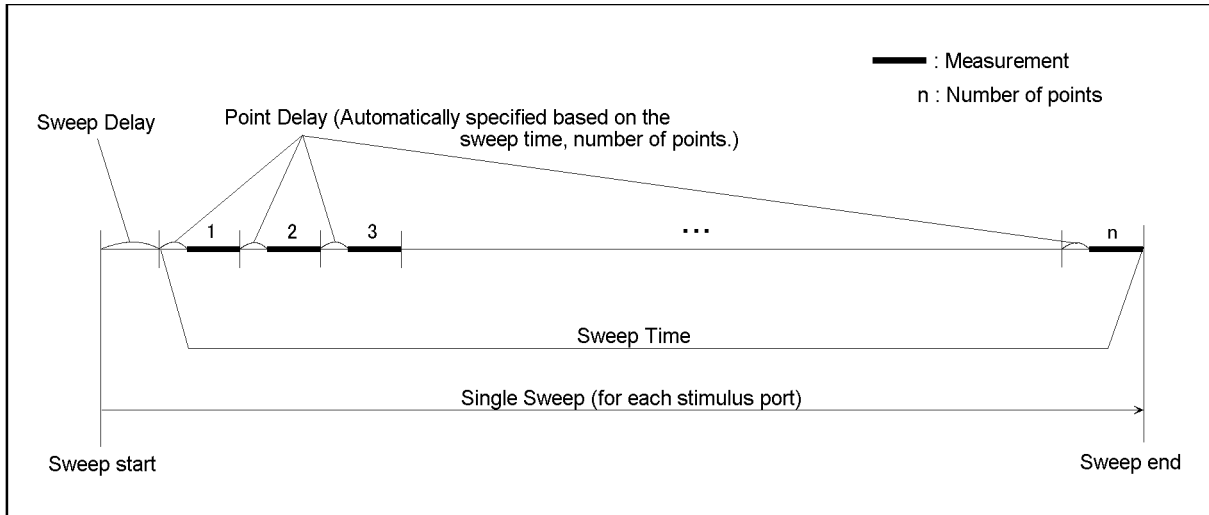

e5070aue119

Sweep delay is time before starting a sweep for each stimulus (source) port

#### Setting Up the Sweep Time (Manual Sweep Time Mode)

- Step 1.** Press **Channel Next** or **Channel Prev** to select the channel for which sweep time will be set.
- Step 2.** Press **Sweep Setup**.
- Step 3.** Press **Sweep Time**.
- Step 4.** Using the ENTRY block keys on the front panel, input the desired sweep time (in seconds).

If the previous operation mode was automatic sweep time mode, entering a new sweep time forces the machine to switch to manual sweep time mode.

#### Switching to Automatic Sweep Time Mode

- Step 1.** Press **Channel Next** or **Channel Prev** to select the channel which will be switched to automatic sweep time mode.
- Step 2.** Press **Sweep Setup**.
- Step 3.** Press **Sweep Time**.
- Step 4.** Press **0** **x1**. (By entering zero (seconds), automatic sweep time becomes effective.)

---

## Selecting Measurement Parameters

The E5061A/E5062A allows users to evaluate the DUT (device under test) characteristics using S-parameters.

### Definition of S-Parameters

S-parameters (scattering parameters) are used to evaluate how signals are reflected by and transferred through the DUT. An S-parameter is defined by the ratio of two complex numbers and contains information about magnitude and phase of the signal. S-parameters are typically expressed as follows.

$$S_{\text{out in}}$$

out: port number of the DUT from which the signal is output

in: port number of the DUT to which the signal is input

For example, S-parameter  $S_{21}$  is the ratio of the output signal of port 2 on the DUT with the input signal of port 1 on the DUT, both expressed in complex numbers.

### Setting Up S-Parameters

**Step 1.** Press **Channel Next** (or **Channel Prev**) and **Trace Next** (or **Trace Prev**) to select the trace for which measurement parameters will be set up.

**Step 2.** Press **Meas**.

**Step 3.** Press a softkey that corresponds to the desired S-parameter.

S-parameters on the softkeys are expressed as follows.

$$S_{\text{out in}}$$

out: test port number of the E5061A/E5062A to which the DUT's output signal is input

in: test port number of the E5061A/E5062A from which the signal is applied to the DUT

## Selecting a Data Format

The E5061A/E5062A allows you to display measured S-parameters using the following data formats:

- o Rectangular display formats
  - Log magnitude format
  - Phase format
  - Expanded phase format
  - Positive phase format
  - Group delay format
  - Linear magnitude format
  - SWR format
  - Real format
  - Imaginary format
- o Polar format
- o Smith chart format

### Rectangular Display Formats

Rectangular display format draws traces by assigning stimulus values (linear scale) to the X-axis and response values to the Y-axis (see Figure 3-6). Nine different formats are available depending on the selection of data for the Y-axis (see Table 3-3).

Figure 3-6

#### Rectangular Display Format

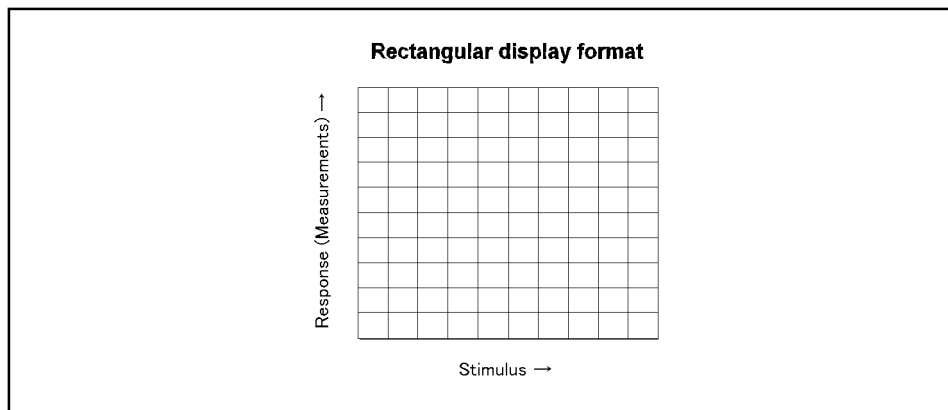

e5070bue070



**Table 3-3** Nine Types of Rectangular Display Formats

| Type                    | Y-axis Data Type   | Y-axis Unit          | Application Examples  |
|-------------------------|--|----------------------|---|
| Log magnitude format    | Magnitude  | dB                   | <ul style="list-style-type: none"> <li>•Return loss measurement</li> <li>•Insertion loss measurement (or gain measurement)</li> </ul> |
| Phase format            | Phase (displayed in the range from $-180^\circ$ to $+180^\circ$ )            | Degrees ( $^\circ$ ) | •Measurement of the deviation from the linear phase   |
| Expanded phase format   | Phase (it is possible to display above $+180^\circ$ and below $-180^\circ$ ) | Degrees ( $^\circ$ ) | •Measurement of the deviation from the linear phase   |
| Positive phase format   | Phase (displayed in the range from $0^\circ$ to $+360^\circ$ )               | Degrees ( $^\circ$ ) | •Measurement of the deviation from the linear phase   |
| Group delay format      | Signal transfer delays within the DUT  | Seconds (s)          | •Group delay measurement  |
| Linear magnitude format | Magnitude  | (Abstract number)    | •Reflection coefficient measurement   |
| SWR format              | $\frac{1 + \rho}{1 - \rho}$ ( $\rho$ : reflection coefficient)               | (Abstract number)    | •Measurement of the standing wave ratio   |
| Real format             | Real part of the measured complex parameter                                  | (Abstract number)    |   |
| Imaginary format        | Imaginary part of the measured complex parameter                             | (Abstract number)    |   |

### Polar Format

In the polar format, traces are drawn by expressing the magnitude as a displacement from the origin (linear) and phase in an angle counterclockwise from the positive X-axis. This data format does not have the stimulus axis so, frequencies must be read using the marker. Also, the polar format allows users to select one of the following three data groups for displaying the marker response values.

- Linear magnitude and phase ( $^\circ$ )
- Log magnitude and phase ( $^\circ$ )
- Real and imaginary parts

**Figure 3-7**

### Polar Format

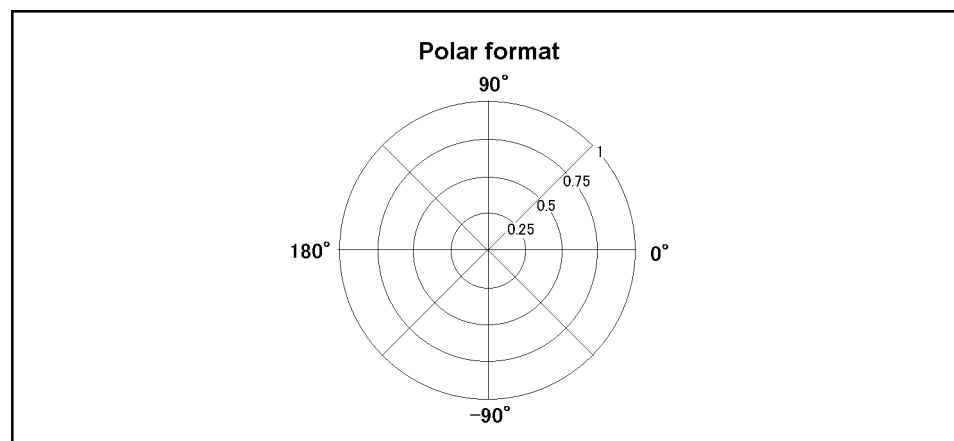

e5070aue030

### Smith Chart Format

The Smith chart format is used to display impedances based on reflection measurement data on the DUT. In this format, traces are plotted on the same spots as in the polar format. The Smith chart format allows users to select one of the following five data groups for displaying the marker response values.

- Linear magnitude and phase ( $^{\circ}$ )
- Log magnitude and phase ( $^{\circ}$ )
- Real and imaginary parts
- Resistance ( $\Omega$ ), reactance ( $\Omega$ ), and inductance (H) or capacitance (F)
- Conductance (S), susceptance (S), and capacitance (F) or inductance (H)

Figure 3-8

### Smith Chart Format

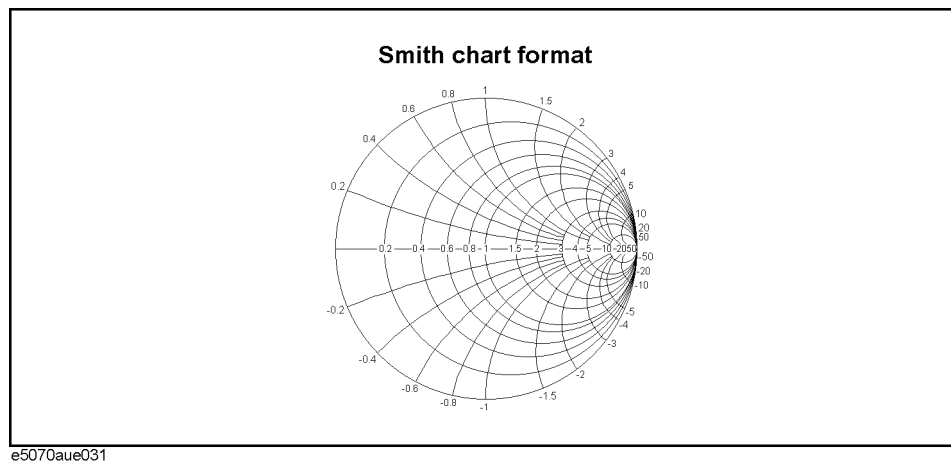

## Selecting a Data Format

Use the following procedure to select a data format.

**Step 1.** Press **Channel Next** (or **Channel Prev**) and **Trace Next** (or **Trace Prev**) to select the trace for which the data format will be set.

**Step 2.** Press **Format**.

**Step 3.** Press the softkey that corresponds to the desired data format.

| Softkey                    | Function  |
|----------------------------|---|
| <b>Log Mag</b>             | Selects the log magnitude format.   |
| <b>Phase</b>               | Selects the phase format.   |
| <b>Group Delay</b>         | Selects the group delay format.   |
| <b>Smith - Lin / Phase</b> | Selects the Smith chart format (with linear magnitude and phase as the marker response values).   |
| <b>Smith - Log / Phase</b> | Selects the Smith chart format (with log magnitude and phase as the marker response values).      |
| <b>Smith - Real / Imag</b> | Selects the Smith chart format (with the real and imaginary parts as the marker response values). |
| <b>Smith - R + jX</b>      | Selects the Smith chart format (with resistance and reactance as the marker response values).     |
| <b>Smith - G + jB</b>      | Selects the Smith chart format (with conductance and susceptance as the marker response values).  |
| <b>Polar - Lin / Phase</b> | Selects the polar format (with linear magnitude and phase as the marker response values).         |
| <b>Polar - Log / Phase</b> | Selects the polar format (with log magnitude and phase as the marker response values).            |
| <b>Polar - Real / Imag</b> | Selects the polar format (with the real and imaginary parts as the marker response values).       |
| <b>Lin Mag</b>             | Selects the linear magnitude format   |
| <b>SWR</b>                 | Selects the SWR (standing wave ratio) format.   |
| <b>Real</b>                | Selects the real format   |
| <b>Imaginary</b>           | Selects the imaginary format  |
| <b>Expand Phase</b>        | Selects the expanded phase format   |
| <b>Positive Phase</b>      | Selects the positive phase format   |

## Setting the Scales

### Auto Scale

The auto scale function is used to tailor each scale (scale/division and the reference line value) automatically in such a way that traces will appear in the proper sizes on the screen for easy observation.

#### Single Trace Auto Scale

Follow the procedure below to perform the auto scale function only on a specific trace.

- Step 1.** Press **Channel Next** (or **Channel Prev**) and **Trace Next** (or **Trace Prev**) to select the trace for which the auto scale function will be performed.
- Step 2.** Press **Scale**.
- Step 3.** Press **Auto Scale**.

#### Auto Scale on All Traces Within a Channel

- Step 1.** Press **Channel Next** (or **Channel Prev**) to select the channel for which the auto scale function will be performed.
- Step 2.** Press **Scale**.
- Step 3.** Press **Auto Scale All**.

### Manual Scale Adjustment on a Rectangular Display Format

For a rectangular display format, four parameters are used to manually adjust the scales. (See Table 3-3 and Figure 3-9.)

**Table 3-4**

#### Adjustable Scale Features on a Rectangular Display Format

| Adjustable Feature                               | Description   |
|--|---|
| Divisions ( <b>Divisions</b> )                   | Defines the number of divisions on the Y-axis. An even number from 4 to 30 must be used. Once set, it is commonly applied to all traces displayed in any rectangular format within that channel.  |
| Scale/Division ( <b>Scale/Div</b> )              | Defines the number of increments per division on the Y-axis. The value applies only to the active trace.  |
| Reference position ( <b>Reference Position</b> ) | Defines the position of the reference line. The position must be specified using the number assigned to each division on the Y-axis starting at 0 (the least significant) running up to the number of divisions being used (the most significant). The position applies only to the active trace. |
| Reference line value ( <b>Reference Value</b> )  | Defines the value corresponding to the reference line. It must be set using the unit on the Y-axis. The reference line value applies only to the active trace.  |

Figure 3-9 Manual Scale Setup on a Rectangular Display Format

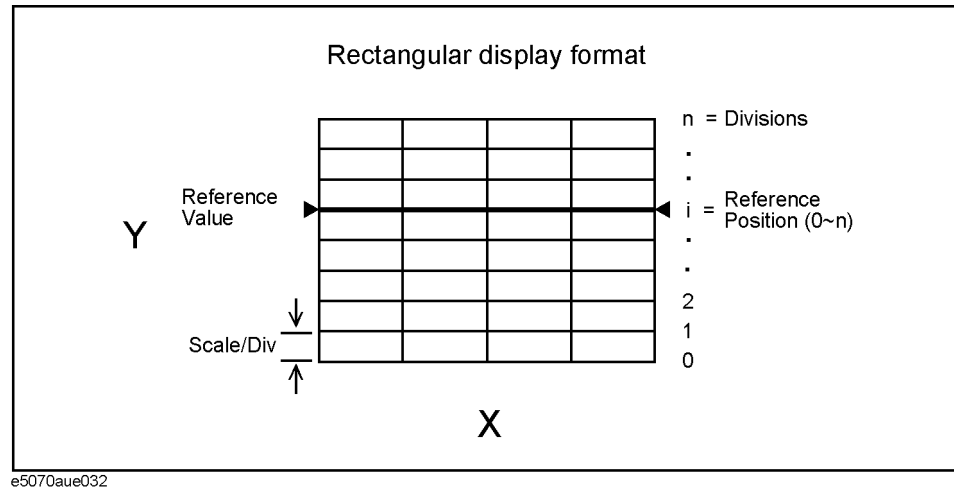

### Manually Setting Scales on a Rectangular Display Format

- Step 1.** Press **Channel Next** (or **Channel Prev**) and **Trace Next** (or **Trace Prev**) to select the trace for which scale features will be adjusted.
- Step 2.** Press **Scale**.
- Step 3.** Press the softkey that corresponds to the particular feature that needs to be adjusted.

| Softkey                   | Function   |
|---------------------------|--|
| <b>Divisions</b>          | Defines the number of divisions on the Y-axis.               |
| <b>Scale/Div</b>          | Defines the number of increments per division on the Y-axis. |
| <b>Reference Position</b> | Defines the position of the reference line.                  |
| <b>Reference Value</b>    | Defines the value corresponding to the reference line.       |

#### NOTE

It is also possible to turn off the display of graticule labels. For details, refer to “Turning Off the Display of Graticule Labels” on page 73.

## Manual Scale Adjustment on the Smith Chart/Polar Format

Manual scale adjustment on the Smith chart format or the polar format is done using the displacement (Scale/Div of the outermost circle. (See Figure 3-10.)

Figure 3-10

### Manual Scale Setup on the Smith Chart/Polar Format

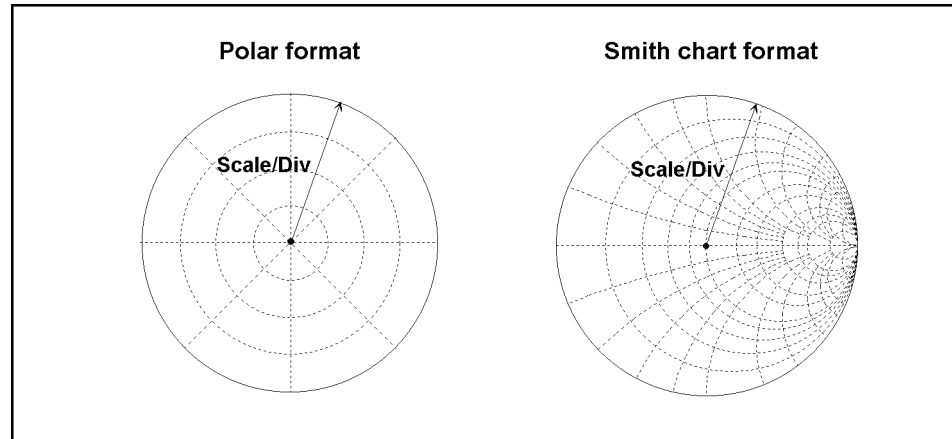

### Manually Setting Scales on the Smith Chart/Polar Format

- Step 1.** Press **Channel Next** (or **Channel Prev**) and **Trace Next** (or **Trace Prev**) to select the trace for which the scale will be adjusted.
- Step 2.** Press **Scale**.
- Step 3.** Press **Scale/Div**.
- Step 4.** Using the ENTRY block keys on the front panel, input the displacement of the outermost circle.

### Setting the Value of a Reference Line Using the Marker

When using a rectangular display format, it is possible to change the reference line value to be equal to the response value of the active marker on the active trace.

### Setting the Reference Line Value Using the Marker

- Step 1.** Place the active marker on the active trace on the position that corresponds to the new reference line value.
- Step 2.** Press **Scale** or **Marker Fctn**.
- Step 3.** Press **Marker** → **Reference** to change the reference line value to the marker response value.

---

#### NOTE

If the reference marker is on and the stimulus value of the active marker is expressed using a value relative to the reference marker, the absolute stimulus value will be used to set the new reference line value.

---

---

## Setting Window Displays

### Maximizing the Specified Window/Trace Display

When using multiple channels, it is possible to maximize a specific channel window on the screen. When multiple traces are displayed in a channel window, it is also possible to maximize a specific trace display within that channel window.

#### Maximizing a Window

**Step 1.** Press **Channel Next** (or **Channel Prev**) to select the channel whose window will be maximized.

**Step 2.** Press **Channel Max** to maximize the channel window.

Press **Channel Max** one more time to reduce the window to its previous size.

#### Maximizing a Trace Display

**Step 1.** Press **Channel Next** (or **Channel Prev**) to select the channel to which the trace belongs.

**Step 2.** Press **Trace Next** (or **Trace Prev**) to select the trace whose display will be maximized.

**Step 3.** Press **Trace Max** to maximize the trace display.

Press **Trace Max** one more time to reduce the display to its previous size.

### Turning Off the Display of Graticule Labels

When using a rectangular display format, the graph area can be expanded to the left by turning off the display of graticule labels.

#### Turning Off Graticule Label Display

**Step 1.** Press **Channel Next** (or **Channel Prev**) to select the channel for which graticule label display will be turned on or off.

**Step 2.** Press **Display**.

**Step 3.** Press **Graticule Label** to turn graticule label display on or off.

## Displaying the Graticule Label Display Using Relative Values

Displays the graticule label on the left side of the Y-axis in the rectangular display format using relative values based on the reference value.

### Setting procedure

- Step 1.** Press **Channel Next** (or **Channel Prev**) to select a channel for which you want to change the graticule label display format.
- Step 2.** Press **Display**.
- Step 3.** Press **Graticule Label** to change the graticule label display format.

| Softkey         | Function   |
|-----------------|--|
| <b>Auto</b>     | Specifies the normal display format.                                   |
| <b>Relative</b> | Specifies the relative value display, relative to the reference value. |



## Hiding Frequency Information

You can hide the frequency information from the screen in order to ensure its confidentiality or for other reasons.

### Hiding Frequency Information on the Screen

Follow the steps below to hide frequency information on the measurement screen.

**Step 1.** Press **Display**.

**Step 2.** Press **Frequency** turn off the frequency display.

#### NOTE

Turning off the frequency display using the **Frequency** key does not erase the frequency display within the Stimulus softkey, which is turned on by pressing **Start**, **Stop**, **Center**, and **Span**. The display of the softkey bar itself can be switched on or off by pressing **Softkey On/Off**.

### Hiding Softkey's Frequency Information

You can delete the frequency information from the measurement screen, which changes the frequency information displayed in the Stimulus softkey and the data entry area for Hz unit to asterisks (\*\*\*) .

**Step 1.** Press **System** - **Service Menu**.

**Step 2.** Press Security Level and select any of the following options for the frequency display.

| Softkey     | Function   |
|-------------|--|
| <b>None</b> | Displays the frequency information.  |
| <b>Low</b>  | Hides the frequency information with a series of asterisks. This can be turned to OFF by the Security Level menu.  |
| <b>High</b> | Hides the frequency information with a series of asterisks. This cannot be turned to OFF by the Security Level menu. Resetting to OFF is only possible by executig Preset or Recall. |

## Setting Measurement Conditions

### Setting Window Displays

#### Labeling a Window

It is possible to assign a unique name to a channel and display it on the screen. This feature is useful in saving and/or printing measurement result for future reference.

#### Labeling a Window

**Step 1.** Press **Channel Next** or **Channel Prev** to select the channel to be labeled.

**Step 2.** Press **Display**.

**Step 3.** Press **Edit Title Label**.

The title label input dialog box (see Figure 3-11) appears.

**Figure 3-11**

#### Title Label Input Dialog Box



**Step 4.** Using keys that appear in the dialog box, type a label and press **Enter**.

**Step 5.** Press **Title Label** to turn on the title display.

The title will appear within a frame at the top of the channel window (title bar). (See Figure 3-12.)

**Figure 3-12**

#### Title Display



## Setting display colors

### Selecting display mode

You can select the display mode of the LCD display from 2 modes: normal display (background: black) or inverted display (background: white). In normal display, the colors of items are preset so that you can recognize them easily on the display of the instrument. On the other hand, in inverted display, they are preset to colors obtained by almost inverting the default settings of the normal display so that you can use data easily when storing it into a graphic file.

The selection procedure is as follows:

**Step 1.** Press **Display**.

**Step 2.** Press **Invert Color** to select the display color. OFF indicates the normal display; ON the inverted display.

### Setting display color for each item

You can set the display color to the normal display or the inverted display separately for each of the following items.

- o Data/memory trace
- o Labels and lines of graphs
- o File display of the limit test and limit lines
- o Background

You set the color of each item by specifying the amounts of red (R), green (G), and blue (B) contained in the color. You can specify each of R, G, and B in 6 steps (0 to 5). Therefore, 216 colors in total are available by combining them. The below table shows the R, G, and B values for main colors for reference purposes.

|               | R | G | B |         | R | G | B |              | R | G | B |
|---------------|---|---|---|---------|---|---|---|--------------|---|---|---|
| White         | 5 | 5 | 5 | Gray    | 2 | 2 | 2 | Black        | 0 | 0 | 0 |
| Light red     | 5 | 3 | 3 | Red     | 5 | 0 | 0 | Dark red     | 2 | 0 | 0 |
| Light yellow  | 5 | 5 | 3 | Yellow  | 5 | 5 | 0 | Dark yellow  | 2 | 2 | 0 |
| Light green   | 3 | 5 | 3 | Green   | 0 | 5 | 0 | Dark green   | 0 | 2 | 0 |
| Light cyan    | 3 | 5 | 5 | Cyan    | 0 | 5 | 5 | Dark cyan    | 0 | 2 | 2 |
| Light blue    | 3 | 3 | 5 | Blue    | 0 | 0 | 5 | Dark blue    | 0 | 0 | 2 |
| Light magenta | 5 | 3 | 5 | Magenta | 5 | 0 | 5 | Dark magenta | 2 | 0 | 2 |

The setting procedure is as follows:

**Step 1.** Press **System**.

**Step 2.** Press **Misc Setup**.

**Step 3.** Press **Color Setup**.

**Step 4.** Press **Normal** (for normal display) or **Invert** (for inverted display).

## Setting Measurement Conditions

### Setting Window Displays

**Step 5.** Press the softkey corresponding to the item for which you want to set the display color.

| Softkey                  | Function   |
|--------------------------|--|
| <b>Data Trace 1 to 4</b> | Specifies the data trace of traces 1 to 4.                   |
| <b>Mem Trace 1 to 4</b>  | Specifies the memory trace of traces 1 to 4.                 |
| <b>Graticule Main</b>    | Specifies the graticule label and the outer lines of graphs. |
| <b>Graticule Sub</b>     | Specifies the grid of graphs.                                |
| <b>Limit Fail</b>        | Specifies the fail display in the limit test result.         |
| <b>Limit Line</b>        | Specifies the limit line.                                    |
| <b>Background</b>        | Specifies the background.                                    |

**Step 6.** Press **Red**.

**Step 7.** Select the amount of red (R) from **0** to **5**.

**Step 8.** Press **Green**.

**Step 9.** Select the amount of green (G) from **0** to **5**.

**Step 10.** Press **Blue**.

**Step 11.** Select the amount of blue (B) from **0** to **5**.

#### Resetting the display colors to the factory state

You can reset the display colors in normal display and inverted display to the preset factory state.

The selection procedure is as follows:

**Step 1.** Press **System**.

**Step 2.** Press **Misc Setup**.

**Step 3.** Press **Color Setup**.

**Step 4.** Press **Normal** (for normal display) or **Invert** (for inverted display).

**Step 5.** Press **Reset Color**.

**Step 6.** Press **OK**.

---

# 4 Calibration

This chapter describes the calibration process to use with the Agilent E5061A/E5062A.

## Measurement Errors and their Characteristics

It is important to understand factors contributing to measurement errors in order to determine the appropriate measures that should be taken to improve accuracy. Measurement errors are classified into three categories:

- Drift errors
- Random errors
- Systematic errors

### Drift Errors

Drift errors are caused by deviations in performance of the measuring instrument (measurement system) that occur after the calibration. Major causes are the thermal expansion of connecting cables and the thermal drift of the frequency converter within the measuring instrument. These errors may be reduced by carrying out frequent calibrations as the ambient temperature changes or by maintaining a stable ambient temperature during the course of a measurement.

### Random Errors

Random errors occur irregularly along the time line. Since random errors are unpredictable, they cannot be eliminated in a calibration. These errors are further classified into the following sub-categories depending on their causes.

- Instrument noise errors
- Switch repeatability errors
- Connector repeatability errors

#### Instrument Noise Errors

Instrument noise errors are caused by electric fluctuations within components used in the measuring instrument. These errors may be reduced by increasing the power of signal supplied to the DUT, narrowing the IF bandwidth, and enabling sweep averaging.

#### Switch Repeatability Errors

Switch repeatability errors occur due to the fact that electrical characteristics of the mechanical RF switch used in the measuring instrument change every time it is switched on. These errors may be reduced by carrying out measurements under conditions in which no switching operation takes place.

You can ignore those errors since the E5061A/E5062A does not have mechanical RF switches.

#### Connector Repeatability Errors

Connector repeatability errors are caused by fluctuations in the electrical characteristics of connectors due to wear. These errors may be reduced by handling connectors with care.

### Systematic Errors

Systematic errors are caused by imperfections in the measuring instrument and the test setup (cables, connectors, fixtures, etc.). Assuming that these errors are repeatable (i.e., predictable) and their characteristics do not change relative to time, then it is possible to eliminate these errors mathematically at the time of measurement by determining the characteristics of these errors in a calibration. There are six types of systematic errors, as follows.

Errors caused by signal leaks in the measuring system:

- Directivity
- Isolation (cross-talk)

Errors caused by reflections in the measuring system:

- Source match
- Load match

Errors caused by the frequency response of the receiver within the measuring instrument:

- Reflection tracking
- Transmission tracking

The E5061A/E5062A has 2 receivers for each test port, the reference receiver and the test receiver (transmission measurement or reflection measurement) and allows you to perform measurements using these receivers at the same time. Figure 4-1 shows the architecture of the test ports of the E5061A/E5062A and systematic errors.

Figure 4-1

E5061A/E5062A Port Architecture and Systematic Errors

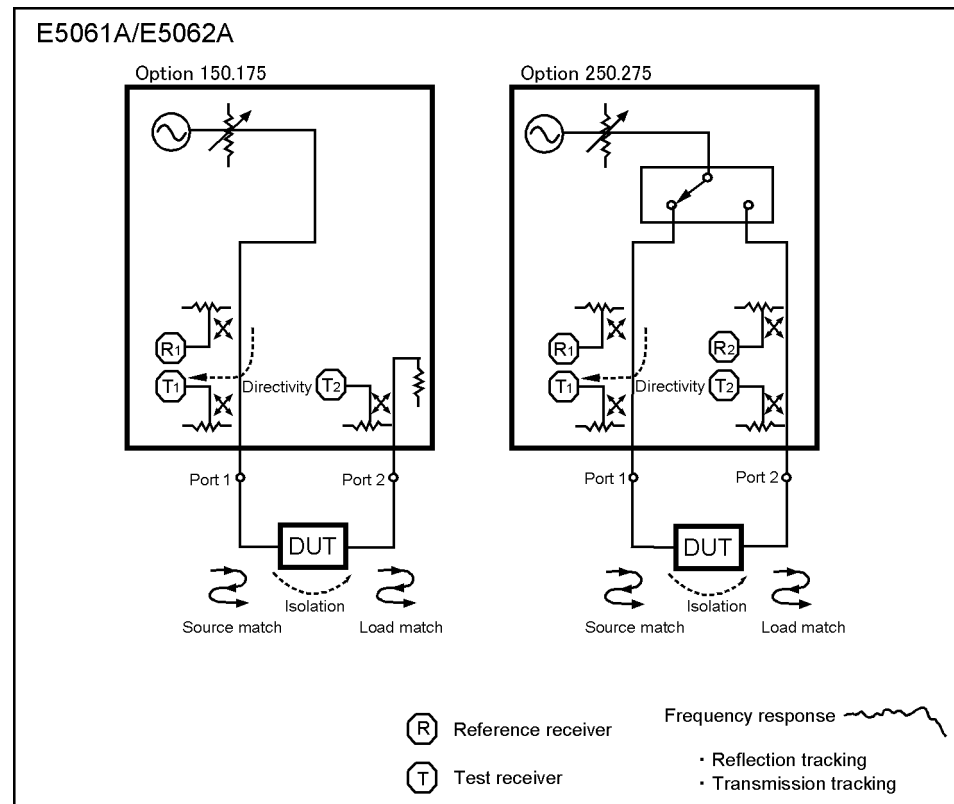

**Directivity error (Ed)**

Directivity errors are caused by the fact that, in a reflection measurement, signals other than the reflection signal from the DUT are received by receiver T1 (see Figure 4-1) through the directivity coupler. When a certain port is a stimulus port, this error can be defined as a constant value for each stimulus port because the state of the termination at the other ports does not change. The number of directivity errors of the E5061A/E5062A is the number of stimulus ports you use.

- Ed1                                      Directivity error of port 1
- Ed2                                      Directivity error of port 2

**Isolation error (Ex)**

An isolation error (crosstalk error) is caused because signals other than the transmission signal of the DUT leak to the test receiver of the transmission measurement port in transmission measurement. When a certain port is a stimulus port, an isolation error is defined for each of the other ports. Therefore, the number of isolation errors of the E5061A/E5062A is the total number of the combinations of stimulus ports and response ports.

- Ex21                                      Isolation error when port 1 is a stimulus port.
- Ex12                                      Isolation error when port 2 is a stimulus port.



**Source match error ( $E_s$ )**

A source match error is caused because the reflection signal of the DUT reflects at the signal source and enters into the DUT again. When a certain port is a stimulus port, this error can be defined as a constant value for each stimulus port because the state of the signal source switch does not change. The number of source match errors of the E5061A/E5062A is the number of stimulus ports you use.

- Es1 Source match error of port 1
- Es2 Source match error of port 2

**Load match error ( $E_l$ )**

A load match error is caused because part of the signal transmitted in the DUT reflects at a response port and all of the signal is not measured by the receiver of the response port. When a certain port is a stimulus port, a load match error is defined for each of the other ports. Therefore, the number of load match errors of the E5061A/E5062A is the total number of the combinations of stimulus ports and response ports.

- E<sub>l</sub>21 Load match error when port 1 is a stimulus port.
- E<sub>l</sub>12 Load match error when port 2 is a stimulus port.

**Reflection tracking error ( $E_r$ )**

A reflection tracking error is caused because the difference in frequency response between the test receiver and the reference receiver of a stimulus port in reflection measurement. This error can be defined as a constant value for each stimulus port because the combination of the test receiver and the reference receiver of a stimulus port is always the same. The number of reflection tracking errors of the E5061A/E5062A is the number of stimulus ports you use.

- Er1 Reflection tracking error of port 1
- Er2 Reflection tracking error of port 2



## Calibration Types and Characteristics

Table 4-1 shows the different types of calibrations and the features of each method.

**Table 4-1 Calibration Types and Characteristics**

| Calibration Method                          | Standard(s) Used  | Corrected Error Factor  | Measurement Parameters                                    | Characteristics  |
|---|---|---|---|--|
| No calibration                              | None  | None  | All parameters  | <ul style="list-style-type: none"> <li>• Low accuracy</li> <li>• Calibration not required</li> </ul>   |
| Response Calibration <sup>*1</sup>          | <ul style="list-style-type: none"> <li>•OPEN or SHORT<sup>*2</sup></li> <li>•LOAD<sup>*3</sup></li> </ul> | Following 2 error terms: <ul style="list-style-type: none"> <li>•Reflection Tracking (Er)</li> <li>•Directivity (Ed)<sup>*3</sup></li> </ul>  | S11 (Reflection characteristics at 1 port)                | <ul style="list-style-type: none"> <li>•Medium accuracy</li> <li>•Quick calibration</li> <li>•An isolation calibration improves the accuracy in a reflection measurement of the DUT that has high return loss</li> </ul>       |
|   | <ul style="list-style-type: none"> <li>•THRU</li> <li>•LOAD<sup>*3</sup></li> </ul>                       | Following 2 error terms: <ul style="list-style-type: none"> <li>•Transmission Tracking (Et)</li> <li>•Isolation (Ex)<sup>*3</sup></li> </ul>  | S21 (1 direction transmission characteristics at 2 ports) | <ul style="list-style-type: none"> <li>•Medium accuracy</li> <li>•Quick calibration</li> <li>•An isolation calibration improves the accuracy in a transmission measurement of a device that has high insertion loss</li> </ul> |
| 1-Port Calibration                          | ECal module (2-port/4-port)   | Following 3 error terms: <ul style="list-style-type: none"> <li>•Directivity (Ed)</li> <li>•Source Match (Es)</li> <li>•Reflection Tracking (Er)</li> </ul>   | S11 (Reflection characteristics at 1 port)                | <ul style="list-style-type: none"> <li>•Highly accurate 1-port measurement</li> <li>•Quick calibration with low chance of operator errors</li> </ul>   |
|   | <ul style="list-style-type: none"> <li>•OPEN</li> <li>•SHORT</li> <li>•LOAD</li> </ul>                    |   |   | <ul style="list-style-type: none"> <li>•Highly accurate 1-port measurement (more accurate than the ECal)</li> </ul>  |
| Enhanced Response Calibration <sup>*1</sup> | ECal module (2-port/4-port)   | Following 5 error terms: <ul style="list-style-type: none"> <li>•Directivity (Ed1)</li> <li>•Isolation (Ex21,Ex12)<sup>*3</sup></li> <li>•Source Match (Es1)</li> <li>•Transmission Tracking (Et21)</li> <li>•Reflection Tracking (Er1)</li> </ul>  | S11,S21,S12,S22 (All S-parameters at 2 ports)             | <ul style="list-style-type: none"> <li>•2-port measurement with higher accuracy than response calibration</li> <li>•Quick calibration with low chance of operator errors</li> </ul>  |
|   | <ul style="list-style-type: none"> <li>•OPEN</li> <li>•SHORT</li> <li>•LOAD</li> <li>•THRU</li> </ul>     |   |   | <ul style="list-style-type: none"> <li>•2-port measurement with higher accuracy than response calibration</li> </ul>   |
| Full 2-Port Calibration <sup>*1</sup>       | ECal module (2-port/4-port)   | Following 12 error terms: <ul style="list-style-type: none"> <li>•Directivity (Ed1,Ed2)</li> <li>•Isolation (Ex21,Ex12)<sup>*3</sup></li> <li>•Source Match (Es1,Es2)</li> <li>•Load Match (El1,El2)</li> <li>•Transmission Tracking (Et21,Et12)</li> <li>•Reflection Tracking (Er1,Er2)</li> </ul> | S11,S21,S12,S22 (All S-parameters at 2 ports)             | <ul style="list-style-type: none"> <li>•Highly accurate 2-port measurement</li> <li>•Quick calibration with low chance of operator errors</li> </ul>   |
|   | <ul style="list-style-type: none"> <li>•OPEN</li> <li>•SHORT</li> <li>•LOAD</li> <li>•THRU</li> </ul>     |   |   | <ul style="list-style-type: none"> <li>•A 2-port measurement with the highest degree of accuracy</li> </ul>  |

\*1. The user may select whether or not to carry out an isolation calibration.

\*2. A general principle is to use an open standard if the impedance of the device is larger than 50 Ω and a short standard if it is less.

\*3. Only when an isolation calibration is carried out. Isolation calibration is not performed when the 2 port ECal module and ECal Assistant VBA macro are used.

---

## Checking Calibration Status

### Execution status of error correction for each channel

You can check the error correction execution status for each channel with the error correction status.

The error correction status is indicated in the channel status bar in the lower part of the window by the symbols in the below table.

| Symbol                         | Execution status of error correction  |
|--------------------------------|---|
| <b>Cor</b> (displayed in blue) | Error correction: On (enabled for all traces)   |
| <b>Cor</b> (displayed in gray) | Error correction: On (enabled for some traces)  |
| <b>Off</b> (displayed in gray) | Error correction: Off   |
| <b>--</b> (displayed in gray)  | Error correction: On (no calibration data)  |
| <b>C?</b> (displayed in blue)  | Error correction: On (Interpolation is being executed or the IF bandwidth, power level, power range, sweep time, sweep delay time, or sweep type is different from that when the calibration was executed.) |
| <b>C!</b> (displayed in blue)  | Error correction: On (Extrapolation is being executed.)   |

### Execution status of error correction for each trace

You can check the status of the error correction actually executed for each trace with the trace status area.

For a trace for which error correction is executed, the applied calibration type is indicated in the trace status area by the symbols in the below table.

| Symbol    | Calibration type              |
|-----------|-------------------------------|
| <b>RO</b> | Open response calibration     |
| <b>RS</b> | Short response calibration    |
| <b>RT</b> | Thru response calibration     |
| <b>ER</b> | Enhanced response calibration |
| <b>F1</b> | 1-port calibration            |
| <b>F2</b> | Full 2-port calibration       |

If no symbol described above is displayed, error correction is not executed for the trace.

For details about the trace status area, see “5-5. Trace Status Area” on page 38.

## Acquisition status of calibration coefficient for each channel

You can check the acquisition status of the calibration coefficient for each channel with the calibration property.

The calibration property displays the acquisition status of the calibration coefficient between test ports for each channel in matrix format. Figure 4-2 shows an example when the calibration coefficients for the enhanced response calibration between test ports 1 and 2 with the port 1 signal source have been acquired.

Figure 4-2

### Example of calibration property display

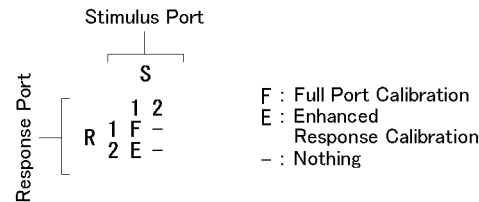

e5061aue004

### Condition to clear already acquired calibration coefficients

In the following cases, already acquired calibration coefficients are cleared.

- If S parameters required to calculate the calibration coefficient for the specified calibration type and test ports and those required for the existing calibration coefficient overlap, executing the acquisition of the calibration coefficient (measuring necessary data and then pressing the **Done** softkey) clears the calibration coefficient for which necessary s parameters overlap. Take Figure 4-2 as an example. If you acquire the calibration coefficient of the 1-port calibration for test port 4, both calibration coefficients are not cleared. On the other hand, if you acquire the calibration coefficient for the full 2-port calibration between test ports 2 and 3, the calibration coefficient of the full 2-port calibration between test ports 1 and 2 and that of the response calibration for test port 3 are cleared.

### NOTE

An asterisk (\*) in the upper right of the softkey displayed when selecting a test port indicates that, if you select the test port and execute the acquisition of the calibration coefficient, the existing calibration coefficient will be cleared.

### Procedure to turn on/off calibration property display

Follow these steps to turn on/off the calibration property display.

- Step 1.** Press **Channel Next** or **Channel Prev** to select the channel for which you want to turn on/off the calibration property display.
- Step 2.** Press **Cal**.
- Step 3.** Press **Property**. Each press toggles between on/off.

---

## Selecting Calibration Kit

Before executing calibration, you need to select a calibration kit you use.

If you use a calibration kit other than predefined, you need to define it. If the connector type of the standard of the calibration kit you use has the polarity (a distinction between male and female), you need to change the standard class definition of the calibration kit depending on the standard you actually use. For more information, see “Changing the Calibration Kit Definition” on page 107.

---

**NOTE**

If you select a predefined calibration kit, (m) and (f) in the name (label) of the standard displayed in the softkey indicate male (m) and female (f) of the connector of the analyzer, respectively.

Follow these steps to select the calibration kit.

- Step 1.** Press **Channel Next** or **Channel Prev** to select the channel for which you want to select the calibration kit.
- Step 2.** Press **Cal**.
- Step 3.** Press **Cal Kit**.
- Step 4.** Select the calibration kit.

| Softkey           | Function                                  |
|-------------------|---|
| <b>85033E</b>     | Selects the calibration kit “85033E.”     |
| <b>85033D</b>     | Selects the calibration kit “85033D.”     |
| <b>85052D</b>     | Selects the calibration kit “85052D.”     |
| <b>85032F</b>     | Selects the calibration kit “85032F.”     |
| <b>85032B/E</b>   | Selects the calibration kit “85032B/E.”   |
| <b>85036B/E</b>   | Selects the calibration kit “85036B/E.”   |
| <b>85039B</b>     | Selects the calibration kit “85039B”.     |
| <b>85038A/F/M</b> | Selects the calibration kit “85038A/F/M”. |
| <b>User</b>       | Selects the calibration kit “User.”       |
| <b>User</b>       | Selects the calibration kit “User.”       |

---

**NOTE**

If the name (label) of the calibration kit has been changed, the label is displayed as the softkey.

---

**NOTE**

An asterisk (\*) on the upper right of the softkey corresponding to a predefined calibration kit indicates that its definition value has been changed from the factory setting by the user.

## OPEN/SHORT Response Calibration (Reflection Test)

In OPEN or SHORT response calibration, calibration data are measured by connecting an OPEN or SHORT standard, respectively, to the desired test port. For frequency response, these calibrations effectively eliminate the reflection tracking error from the test setup in a reflection test using that port (Figure 4-3). It is also possible to carry out isolation calibration with a LOAD standard during OPEN/SHORT response calibration. An isolation calibration will eliminate the directivity error from the test setup in a reflection test using that port (Figure 4-4).

**Figure 4-3**

**1-Port Error Model (OPEN/SHORT Response)**

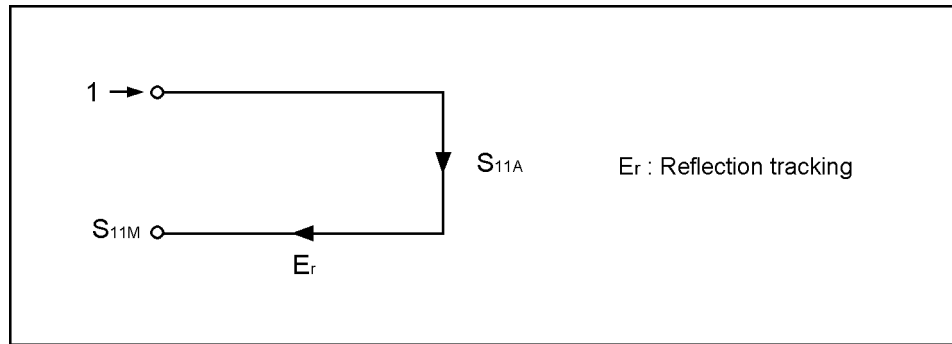

e5070aue148

**Figure 4-4**

**1-Port Error Model (OPEN/SHORT Response + Isolation)**

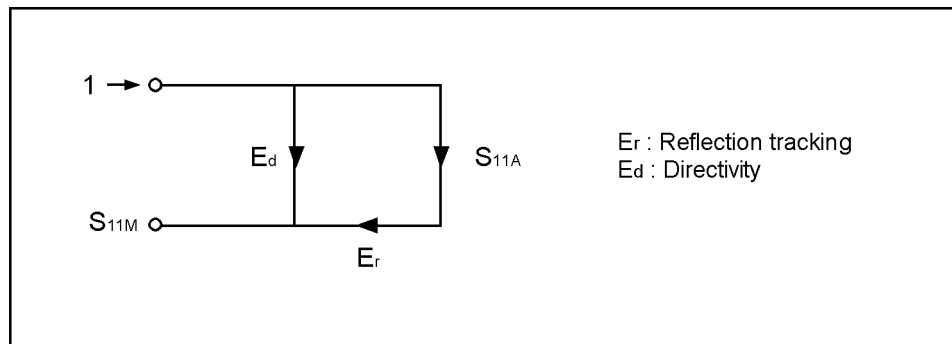

e5070aue149

### Procedure

- Step 1.** Press **Channel Next** or **Channel Prev** to select the channel for which you want to perform the calibration.
- Step 2.** Press **Cal**.
- Step 3.** Press **Calibrate**.

Calibration  
**OPEN/SHORT Response Calibration (Reflection Test)**

**Step 4.** Select OPEN or SHORT response calibration.

| Softkey                 | Function  |
|-------------------------|---|
| <b>Response (Open)</b>  | Displays softkeys for performing an open response calibration (response calibration with an OPEN standard). |
| <b>Response (Short)</b> | Displays softkeys for performing a SHORT response calibration (response calibration with a SHORT standard). |

**Step 5.** Press **Port** to select a test port upon which an OPEN/SHORT response calibration will be performed.

| Softkey display | Function        |
|-----------------|-----------------|
| 1               | Selects port 1. |
| 2               | Selects port 2. |

**NOTE**

An asterisk (\*) in the upper right of the softkey indicates that, if you select the test port and execute the acquisition of the calibration coefficient (press **Done**), the existing calibration coefficient will be cleared.

**Step 6.** According to the selection made in Step 4, connect an OPEN or SHORT calibration standard to the test port (connector to which the DUT will be connected) selected in Step 5.

**Figure 4-5**

**Connecting the standard at OPEN/SHORT Response Calibration**

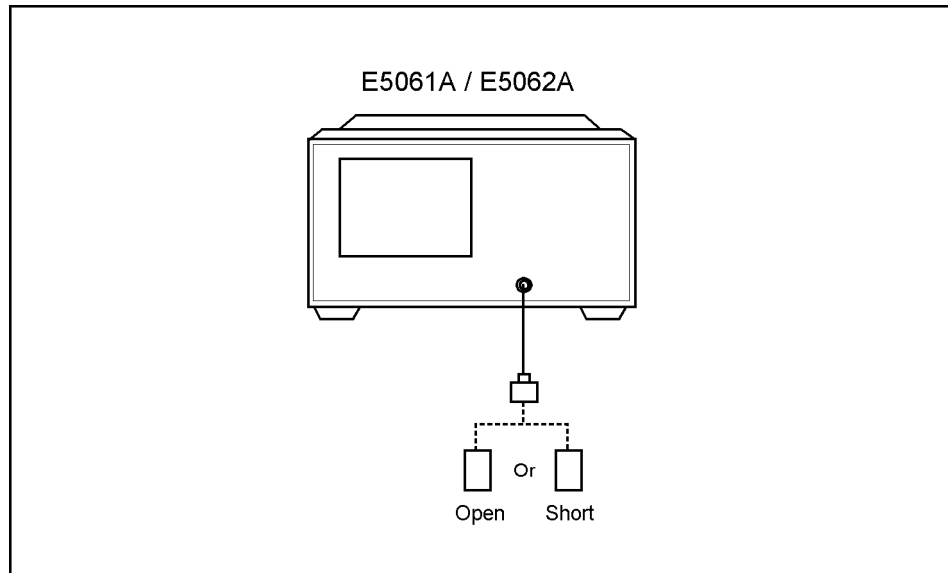

e5061aue005

**Step 7.** Press **Open** or **Short** to start the calibration measurement.

**Step 8.** If an isolation calibration must be performed using a LOAD standard, follow the procedure below.

- a. Connect a LOAD standard to the test port (connector to which the DUT will be



connected) selected in Step 5.

**Figure 4-6** Connecting the Load Standard

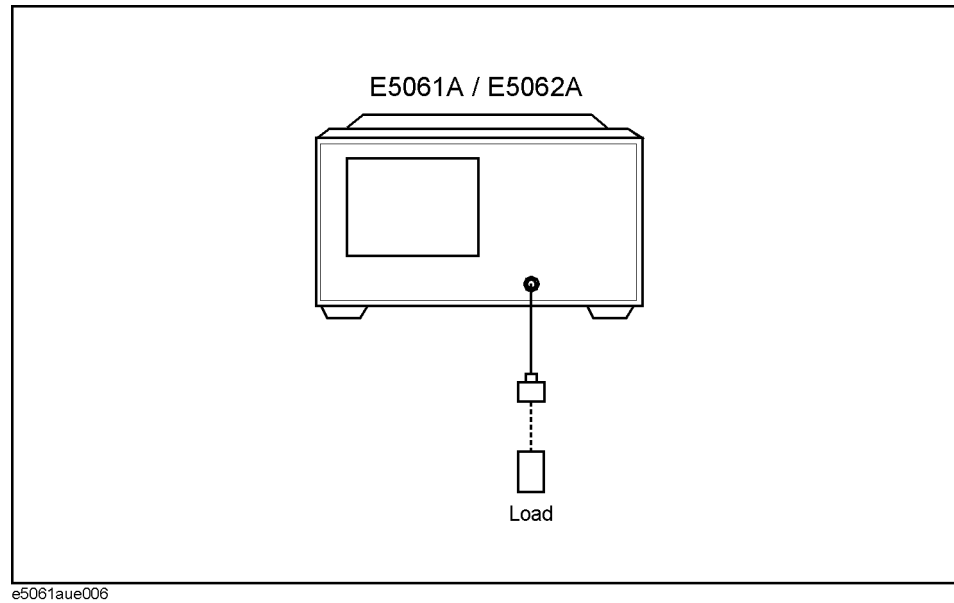

**b.** Press **Load (Optional)** to start the measurement on the LOAD standard.

**Step 9.** Press **Done** to terminate the response calibration (and the LOAD isolation calibration) process. Upon pressing the key, calibration coefficients will be calculated and saved. The error correction function will also be automatically enabled.

## THRU Response Calibration (Transmission Test)

In THRU response calibration, calibration data are measured by connecting a THRU standard to the desired test port. This calibration effectively eliminates the frequency response transmission tracking error from the test setup in a transmission test using that port (Figure 4-7). It is also possible to carry out an isolation calibration using a LOAD standard in the process of THRU response calibration. An isolation calibration will eliminate isolation error (crosstalk error) from the test setup in a transmission test using that port.

Figure 4-7

2-Port Error Model (Thru Response)

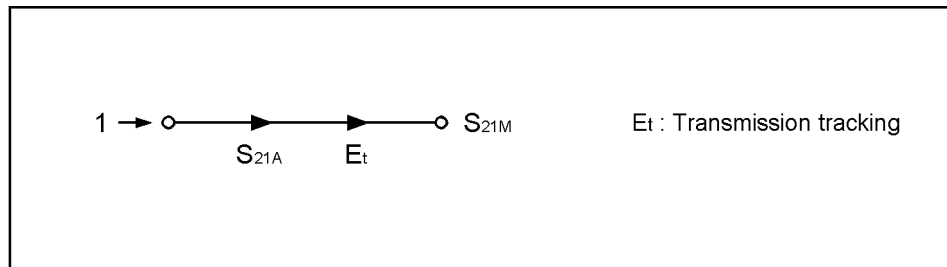

e5070aue150

Figure 4-8

2-Port Error Model (Thru Response + Isolation)

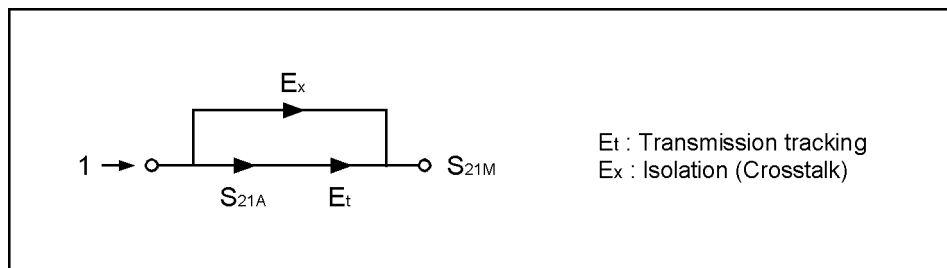

e5070aue151

### Procedure

- Step 1.** Press **Channel Next** or **Channel Prev** to select the channel for which you want to perform the calibration.
- Step 2.** Press **Cal**.
- Step 3.** Press **Calibrate**.
- Step 4.** Press **Response (Thru)**.
- Step 5.** Press **Ports** to select the test ports (and corresponding S parameters) upon which a THRU response calibration will be performed.

| Softkey display | Function   |
|-----------------|--|
| 2-1 (S21)       | Selects test port 2 (input) and test port 1 (output). Corresponds to the determination of $S_{21}$ . |
| 1-2 (S12)       | Selects test port 1 (input) and test port 2 (output). Corresponds to the determination of $S_{12}$ . |

---

**NOTE** An asterisk (\*) in the upper right of the softkey indicates that, if you select the test port and execute the acquisition of the calibration coefficient (press **Done**), the existing calibration coefficient will be cleared.

---

**Step 6.** Make a THRU connection between the test ports (between the connectors to which the DUT will be connected) selected in Step 5.

**Figure 4-9** Connecting at Thru Response Calibration

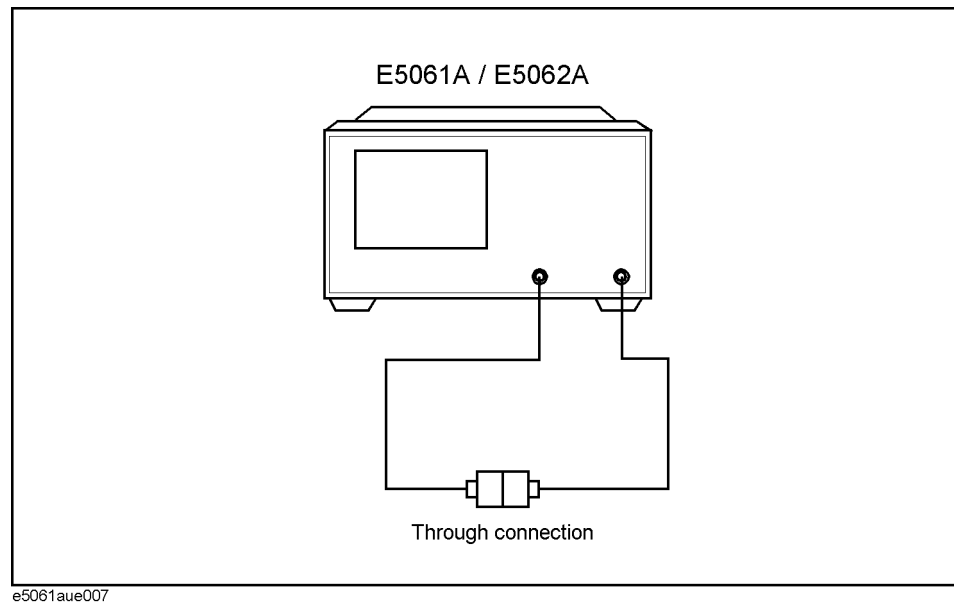

**Step 7.** Press **Thru** to start the calibration measurement.

**Step 8.** If an isolation calibration must be performed using a LOAD standard, follow the procedure below.

- a. Connect a LOAD standard to each of the two test ports.

Figure 4-10 Connecting the Load Standard

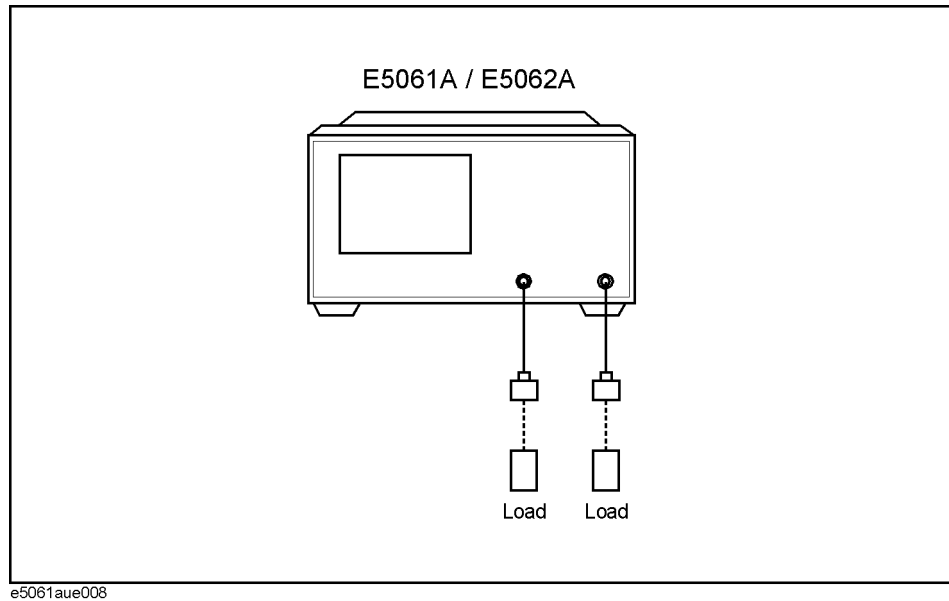

b. Press **Isolation (Optional)** to start the calibration measurement.

**Step 9.** Press **Done** to terminate the response calibration (and the load isolation calibration) process. Upon pressing the key, calibration coefficients will be calculated and saved. The error correction function will also be automatically enabled.

### 1-Port Calibration (Reflection Test)

In 1-port calibration, calibration data are measured by connecting an OPEN standard, a SHORT standard, and a LOAD standard to the desired test port. This calibration effectively eliminates the frequency response reflection tracking error, directivity error, and source match error from the test setup in a reflection test using that port (Figure 4-11).

Figure 4-11

1-Port Error Model (1-Port Calibration)

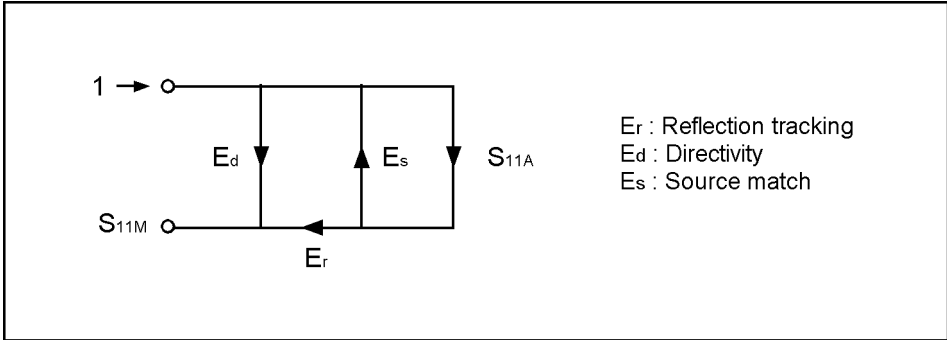

e5070aue152

### Procedure

Figure 4-12

Connecting the Standard at 1-Port Calibration

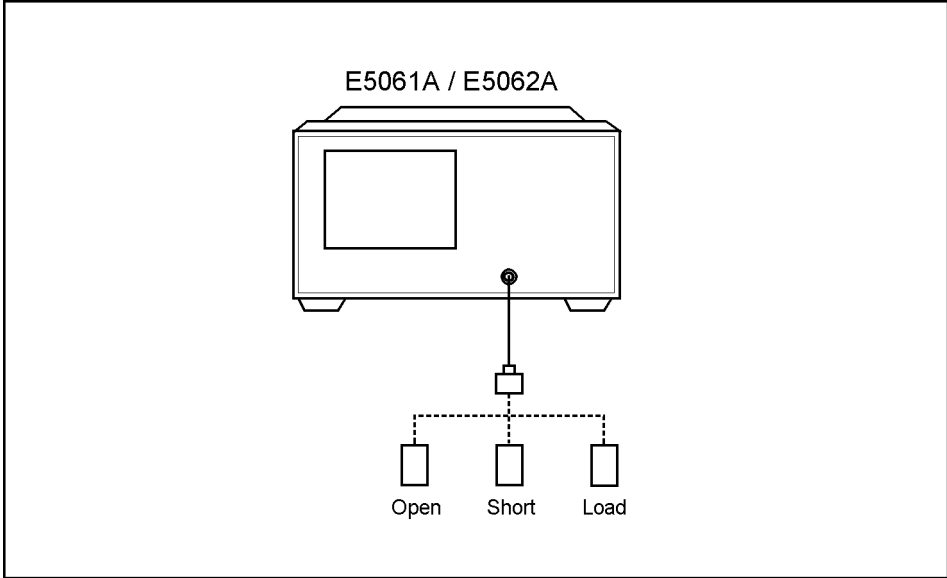

e5061aue009

## Calibration

### 1-Port Calibration (Reflection Test)

- Step 1.** Press **Channel Next** or **Channel Prev** to select the channel for which you want to perform the calibration.
- Step 2.** Press **Cal**.
- Step 3.** Press **Calibrate**.
- Step 4.** Press **1-Port Cal**.
- Step 5.** Press **Port** to select a test port (and corresponding S parameter) on which a 1-port calibration will be performed.

| Softkey | Function        |
|---------|-----------------|
| 1       | Selects port 1. |
| 2       | Selects port 2. |

---

#### NOTE

An asterisk (\*) in the upper right of the softkey indicates that, if you select the test port and execute the acquisition of the calibration coefficient (press **Done**), the existing calibration coefficient will be cleared.

- Step 6.** Connect an OPEN calibration standard to the test port (connector to which the DUT will be connected) selected in Step 5.
- Step 7.** Press **Open** to start the calibration measurement.
- Step 8.** Connect a SHORT calibration standard to the test port (connector to which the DUT will be connected) selected in Step 5.
- Step 9.** Press **Short** to start the calibration measurement.
- Step 10.** Connect a LOAD calibration standard to the test port (connector to which the DUT will be connected) selected in Step 5.
- Step 11.** Press **Load** to start the calibration measurement.
- Step 12.** Press **Done** to terminate the 1-port calibration process. Upon pressing the key, calibration coefficients will be calculated and saved. The error correction function will also be automatically enabled.

## Enhanced Response Calibration

In enhanced response calibration, calibration data are measured by connecting an OPEN standard, a SHORT standard, or a LOAD standard to the output port (or a THRU standard between two ports). This calibration effectively eliminates the directivity error, crosstalk, source match error, frequency response reflection tracking error, and frequency response transmission tracking error from the test setup in a transmission or reflection test using those ports (Figure 4-13).

Figure 4-13 2-Port Error Model (Enhanced Response)

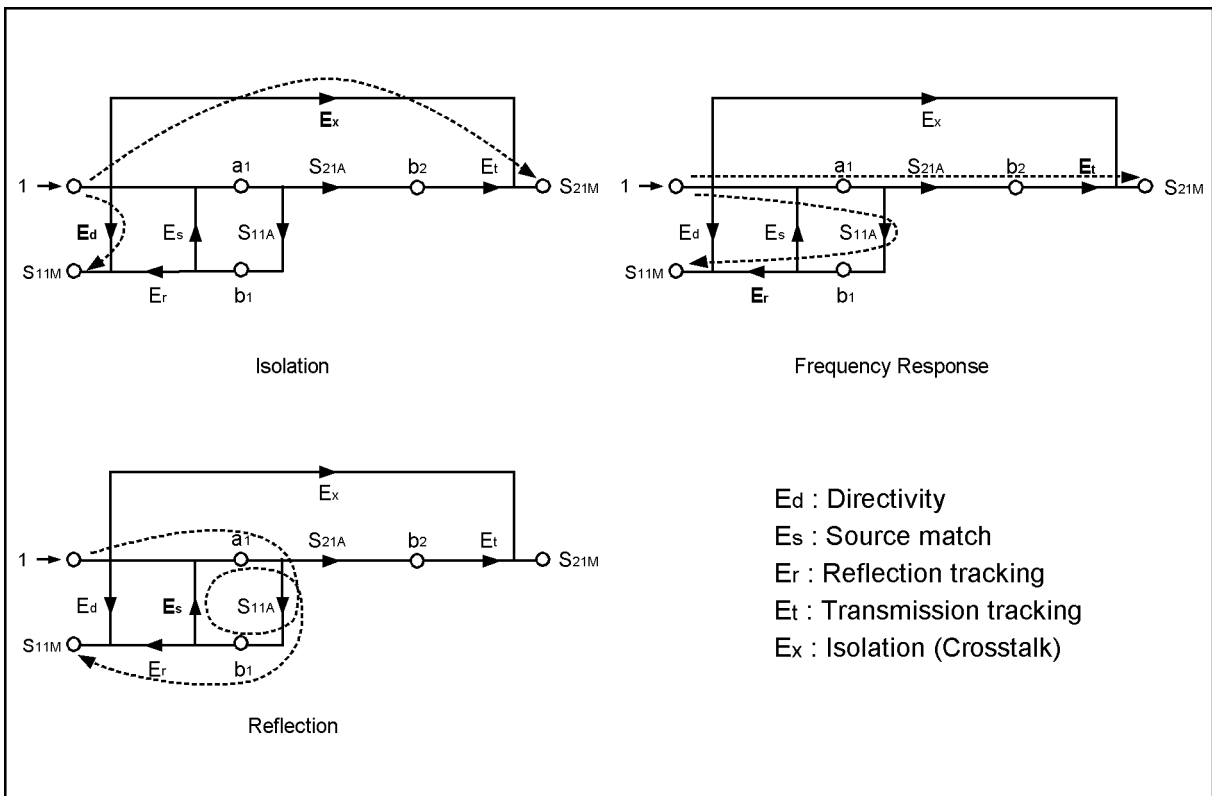

e5061aue010

**Procedure**

**Figure 4-14** Connecting the Standard at Enhanced Response Calibration

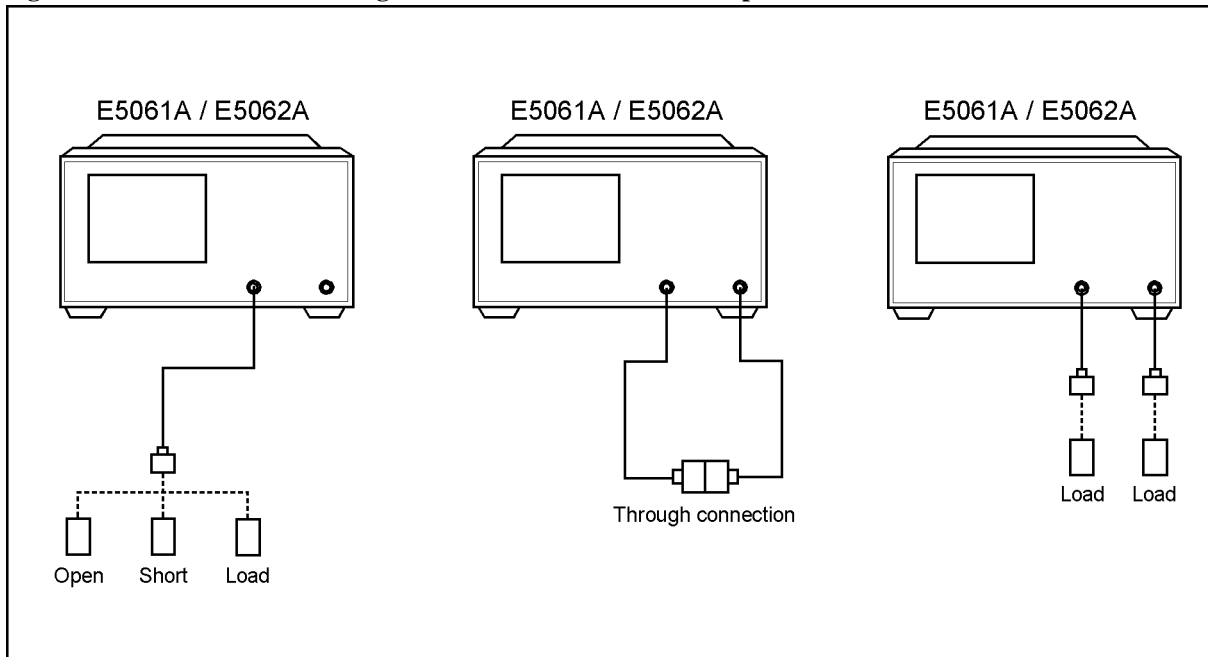

e5061aue020

- Step 1.** Press **Channel Next** or **Channel Prev** to select the channel for which you want to perform the calibration.
- Step 2.** Press **Cal**.
- Step 3.** Press **Calibrate**.
- Step 4.** Press **Enhanced Response**.
- Step 5.** Press **Ports** to select the test ports on which an enhanced response calibration will be performed.)

| Softkey display | Function                       |
|-----------------|--------------------------------|
| 2-1(S21 S11)    | Selects test port 1 as output. |
| 1-2(S12 S22)    | Selects test port 2 as output. |

**NOTE**

An asterisk (\*) in the upper right of the softkey indicates that, if you select the test port and execute the acquisition of the calibration coefficient (press **Done**), the existing calibration coefficient will be cleared.

- Step 6.** Connect an OPEN calibration standard to the output port.
- Step 7.** Press **Open** to start the calibration measurement.
- Step 8.** Disconnect the OPEN calibration standard that was connected in Step 6 and replace it with



a SHORT calibration standard.

**Step 9.** Press **Short** to start the calibration measurement.

**Step 10.** Disconnect the SHORT calibration standard that was connected in Step 6 and replace it with a LOAD standard.

**Step 11.** Press **Load** to start the calibration measurement.

**Step 12.** Make a THRU connection between the two ports.

**Step 13.** Press **Thru** to start the calibration measurement.

**Step 14.** If an isolation calibration must be performed using a LOAD standard, follow the procedure below.

c. Connect a LOAD standard to the two test ports.

d. Press **Isolation (Optional)** to start the calibration measurement.

**Step 15.** Press **Return**.

**Step 16.** Press **Done** to terminate the enhanced response calibration process. Upon pressing the key, calibration coefficients will be calculated and saved. The error correction function will also be automatically enabled.

## Full 2-Port Calibration

In full 2-port calibration, calibration data are measured by connecting an OPEN standard, a SHORT standard, or a LOAD standard to two desired test ports (or a THRU standard between two ports). This calibration effectively eliminates the directivity error, crosstalk, source match error, frequency response reflection tracking error, and frequency response transmission tracking error from the test setup in a transmission or reflection test using those ports (Figure 4-13). This calibration makes it possible to perform measurements with the highest possible accuracy. A total of twelve error terms, six each in the forward direction and the reverse direction, are used in a calibration.

Figure 4-15 Full 2-Port Error Model (Forward)

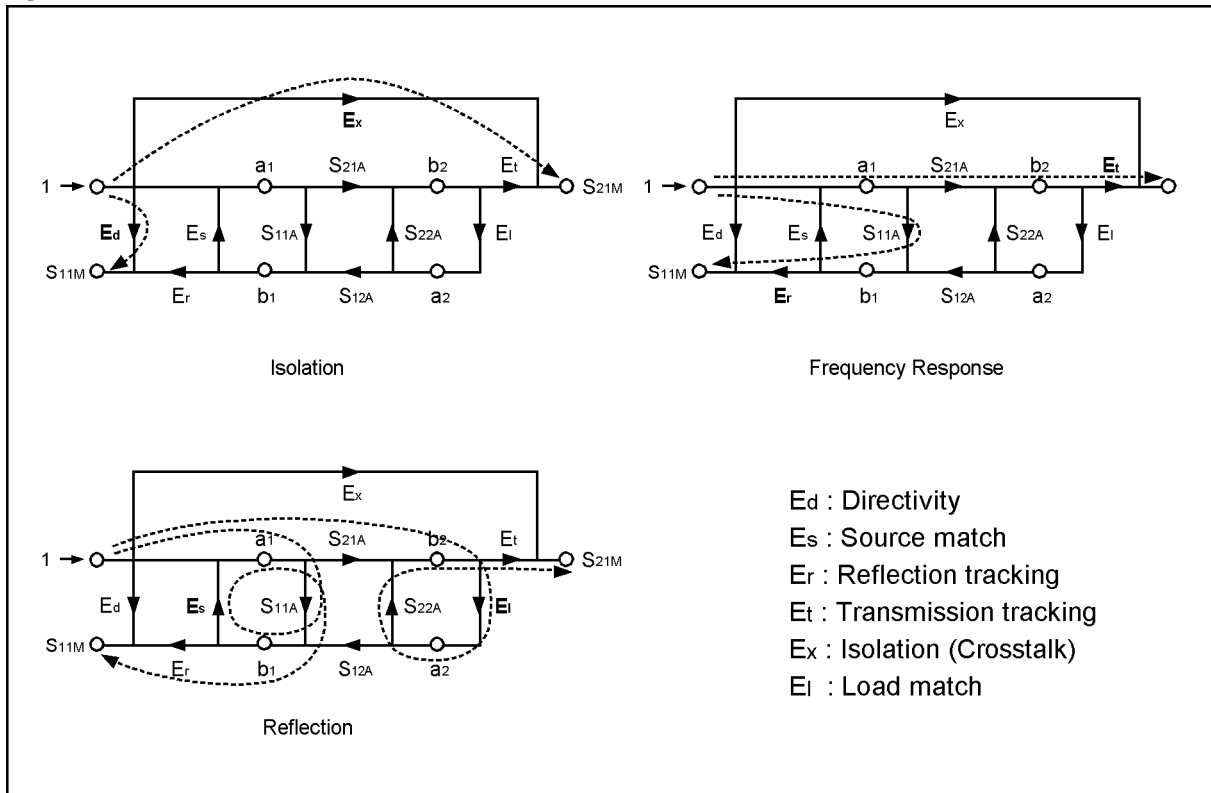

e5070aue144

## Procedure

Figure 4-16 Connecting the Standard at Full 2-Port Calibration

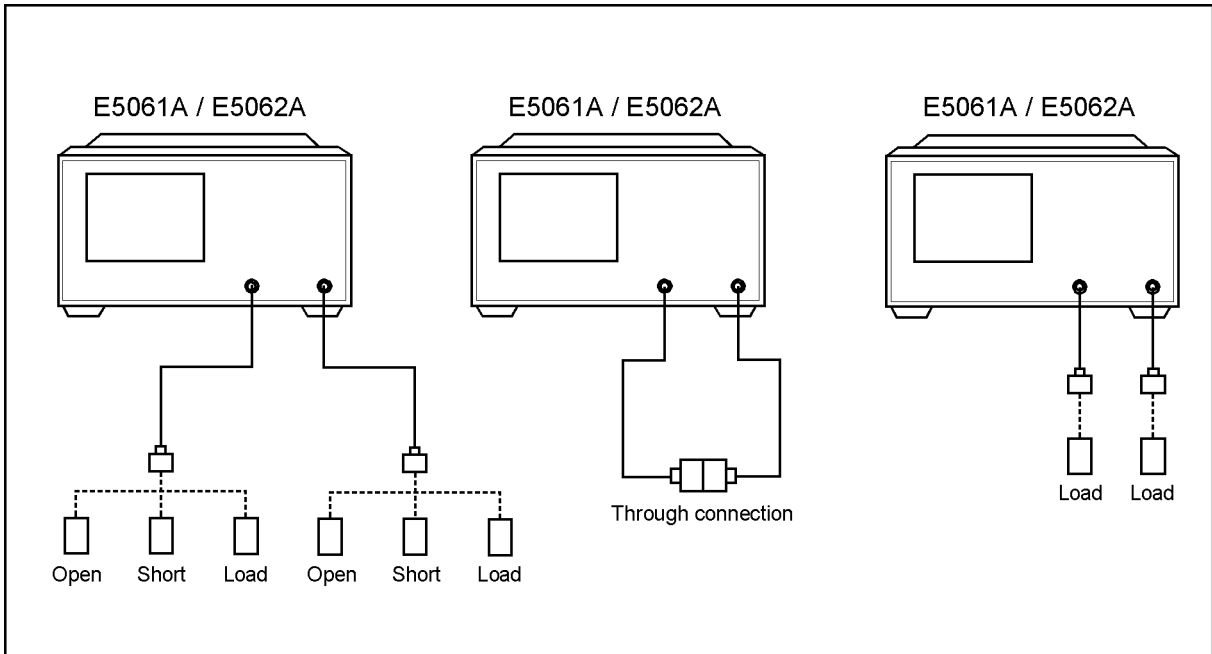

e5061aue011

- Step 1.** Press **Channel Next** or **Channel Prev** to select the channel for which you want to perform the calibration.
- Step 2.** Press **Cal**.
- Step 3.** Press **Calibrate**.
- Step 4.** Press **2-Port Cal**.
- Step 5.** Press **Reflection**.
- Step 6.** Connect an OPEN calibration standard to test port x (the connector to which the DUT will be connected).
- Step 7.** Press **Port x Open** to start the calibration measurement (x denotes the test port to which the standard is connected).
- Step 8.** Disconnect the OPEN calibration standard that was connected in Step 6 and replace it with a SHORT calibration standard.
- Step 9.** Press **Port x Short** to start the calibration measurement (x denotes the test port to which the standard is connected).
- Step 10.** Disconnect the SHORT calibration standard that was connected in Step 6 and replace it with a LOAD standard.
- Step 11.** Press **Port x Load** to start the calibration measurement (x denotes the test port to which the standard is connected).
- Step 12.** Repeat Step 6 to Step 11 for the other port.

## Calibration

### Full 2-Port Calibration

- Step 13.** Press **Return**.
- Step 14.** Press **Transmission**.
- Step 15.** Make a THRU connection between the two ports.
- Step 16.** Press **Port 1-2 Thru** to start the calibration measurement.
- Step 17.** Press **Return**.
- Step 18.** If an isolation calibration must be performed using a LOAD standard, follow the procedure below.
- a. Press **Isolation (Optional)**.
  - b. Connect a LOAD standard to each of the two test ports.
  - c. Press **Port 1-2 Isol** to start the calibration measurement.
- Step 19.** Press **Return**.
- Step 20.** Press **Done** to terminate the full 2-port calibration process. Upon pressing the key, calibration coefficients will be calculated and saved. The error correction function will also be automatically enabled.

## ECal (Electronic Calibration)

ECal is a calibration method that uses solid state circuit technology. ECal has following advantages:

- Simplifies the calibration process.
- Shortens the time required for calibration.
- Reduces the chances for erroneous manipulation.
- Prevents inferior performance due to wear because the ECal module employs PIN diodes and FET switches.

### 1-Port Calibration Using the ECal Module

Follow the procedure below to perform a 1-port calibration using the ECal module.

- Step 1.** Connect the USB port on the ECal module with the USB port on the E5061A/E5062A using a USB cable. This connection may be done with the E5061A/E5062A power on.
- Step 2.** Connect port on the ECal module to the test port that needs to be calibrated.

**NOTE** You can connect the ports of the ECal and the test ports of the E5061A/E5062A arbitrarily.

**NOTE** If you don't use all ports of the ECal, connect terminations to the unused ports.

**Figure 4-17** Connecting the ECal Module (1-Port Calibration)

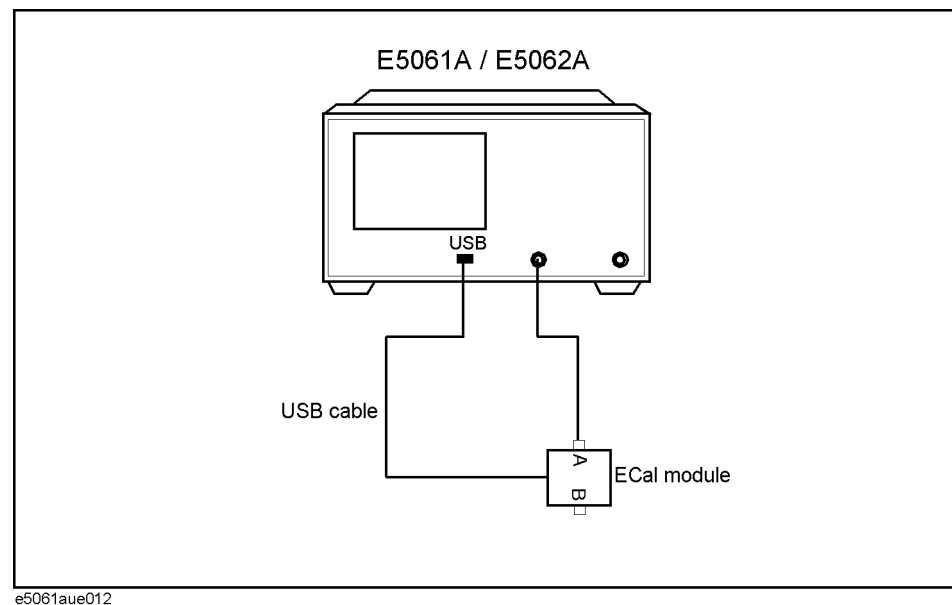

- Step 3.** Press **Channel Next** or **Channel Prev** to select the channel for which you want to perform the calibration.

## Calibration

### ECal (Electronic Calibration)

**Step 4.** Press **Cal**.

**Step 5.** Press **ECal**.

**Step 6.** Press **1 Port ECal**.

**Step 7.** Perform a 1-port calibration.

| Softkey       | Function                                      |
|---------------|---|
| <b>Port 1</b> | Performs a 1-port calibration on test port 1. |
| <b>Port 2</b> | Performs a 1-port calibration on test port 2. |

### Enhanced Response Calibration Using the ECal Module

Follow the procedure below to perform an enhanced response calibration using the ECal module.

**Step 1.** Connect the USB port on the ECal module with the USB port on the E5061A/E5062A using a USB cable. This connection may be done with the E5061A/E5062A power on.

**Step 2.** Connect port A and port B on the ECal module to the test ports that need to be calibrated.

#### NOTE

If an analyzer is equipped with an S-parameter test set, you can connect the ports of the ECal and the test ports of the E5061A/E5062A arbitrarily. In case of a T/R test set, one of the connections in Table 4-2 needs to be used.

**Table 4-2**

**4-Port ECal connection to T/R test set**

| Port 1 | Port 2 |
|--------|--------|
| PORT A | PORT B |
| PORT B | PORT C |
| PORT C | PORT D |
| PORT D | PORT A |

**Figure 4-18**

**Connecting the ECal Module (Enhanced Response Calibration)**

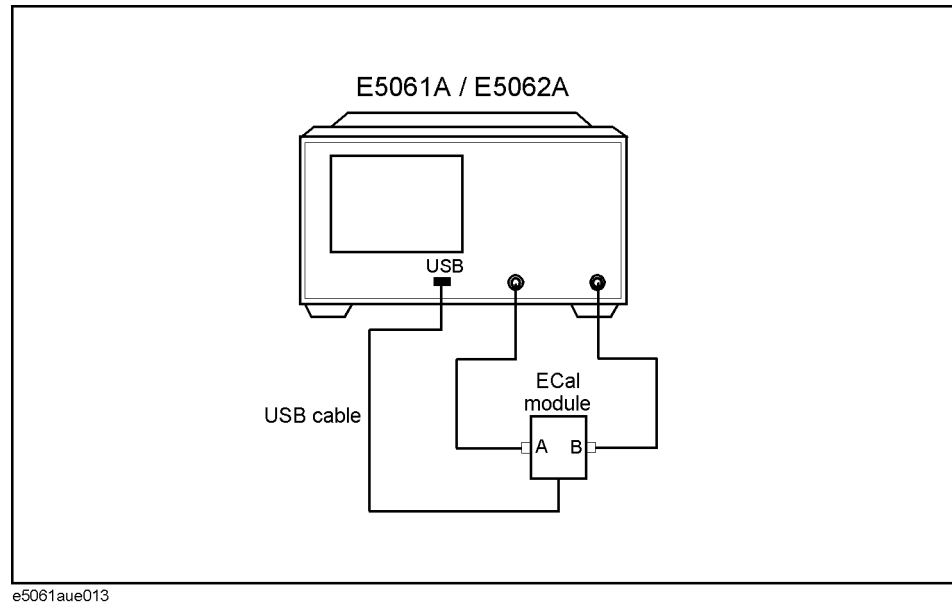

e5061aue013

- Step 3.** Press **Channel Next** or **Channel Prev** to select the channel for which you want to perform the calibration.
- Step 4.** Press **Cal**.
- Step 5.** Press **ECal**.
- Step 6.** To enable isolation calibration, press **Isolation** and confirm that the display turns **ON**.
- Step 7.** Press **Enhanced Response**.
- Step 8.** Press one of the softkeys below to start an enhanced response calibration.

| Softkey              | Function  |
|----------------------|---|
| <b>2-1 (S21 S11)</b> | Performs an enhanced response calibration with port 1 output. |
| <b>1-2 (S12 S22)</b> | Performs an enhanced response calibration with port 2 output. |

### Full 2-Port Calibration Using the ECal Module

Follow the procedure below to perform a full 2-port calibration using the ECal module.

- Step 1.** Connect the USB port on the ECal module with the USB port on the E5061A/E5062A using a USB cable. This connection may be done with the E5061A/E5062A power on.
- Step 2.** Connect port A and port B on the ECal module to the test ports that need to be calibrated.

**NOTE**

You can connect the ports of the ECal and the test ports of the E5061A/E5062A arbitrarily.

Calibration  
**ECal (Electronic Calibration)**

**Figure 4-19**

**Connecting the ECal Module (Full 2-Port Calibration)**

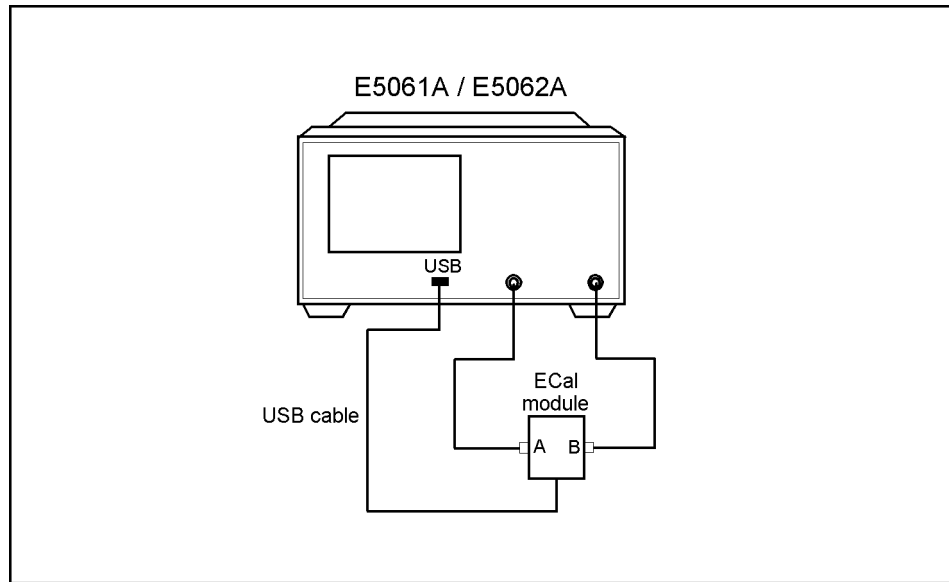

e5061aue013

- Step 3.** Press **Channel Next** or **Channel Prev** to select the channel for which you want to perform the calibration.
- Step 4.** Press **Cal**.
- Step 5.** Press **ECal**.
- Step 6.** To enable isolation calibration, press **Isolation** and confirm that the display turns **ON**.
- Step 7.** Press **2 Port ECal** to perform a 2-port ECal.



---

## Changing the Calibration Kit Definition

In most measurements, the user can use pre-defined calibration kits as they are. However, it may be necessary to change the definition of a calibration kit (or create a new one) when a special standard is used or a high degree of accuracy is demanded. When it is necessary to change the definition of a calibration kit that contains a calibration device but no calibration kit model, the user must fully understand error correction and the system error model.

A user-defined calibration kit may be used in the following circumstances.

- When the user wants to use connectors other than those pre-defined in the calibration kits for the E5061A/E5062A (e.g., a SMA connector).
- When the user wants to use different standards in place of one or more standards pre-defined in the E5061A/E5062A. For example, when three offset SHORT standards are used instead of OPEN, SHORT, and LOAD standards.
- When the user wants to modify the standard model of a pre-defined calibration kit and turn it into a more accurate model. It is possible to perform better calibration if the performance of the actual standard is reflected in the standard model better. For example, define the 7 mm load standard as 50.4  $\Omega$  instead of 50.0  $\Omega$ .

### Definitions of Terms

The terms used in this section are defined as follows:

|                             |   |
|-----------------------------|---|
| <b>Standard</b>             | An accurate physical device, for which the model is clearly defined, and is used to determine system errors. With the E5061A/E5062A, the user may define up to 21 standards per calibration kit. Each standard is numbered, from 1 through 21. For example, standard 1 for the 85033E 3.5 mm calibration kit is a SHORT standard. |
| <b>Standard type</b>        | The type of standard used to classify a standard model based on its form and construction. Five standard types are available: SHORT, OPEN, LOAD, delay/THRU, and arbitrary impedance.   |
| <b>Standard coefficient</b> | The numeric characteristics of the standard used in the selected model. For example, the offset delay (32 ps) of the SHORT standard in the 3.5 mm calibration kit is a standard coefficient.  |
| <b>Standard class</b>       | A group of standards used in a calibration process. For each class, the user must select the standards to use from the 21 available standards.  |

### Defining Parameters for Standards

Figure 4-20 and Figure 4-21 show the parameters used in defining standards.

**Figure 4-20** Reflection Standard Model (SHORT, OPEN, or LOAD)

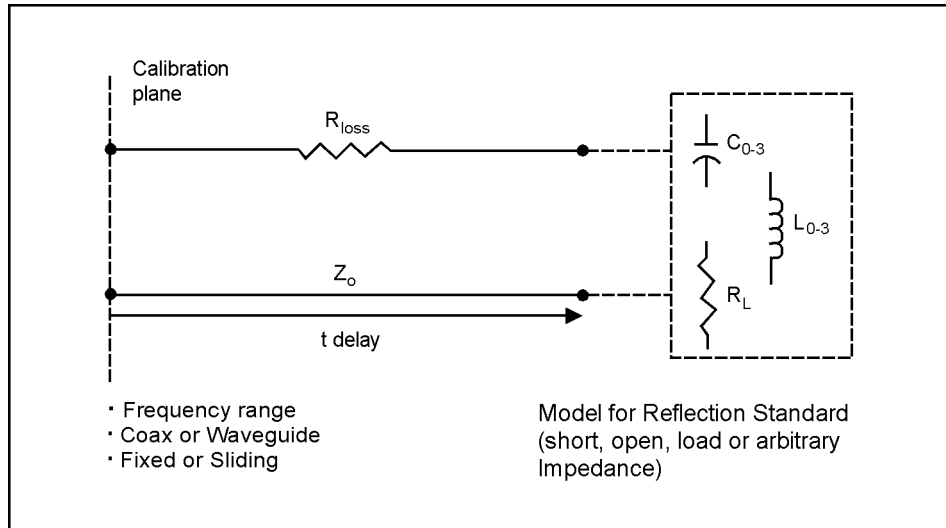

e5070aue004

**Figure 4-21** Transmission Standard Model (THRU)

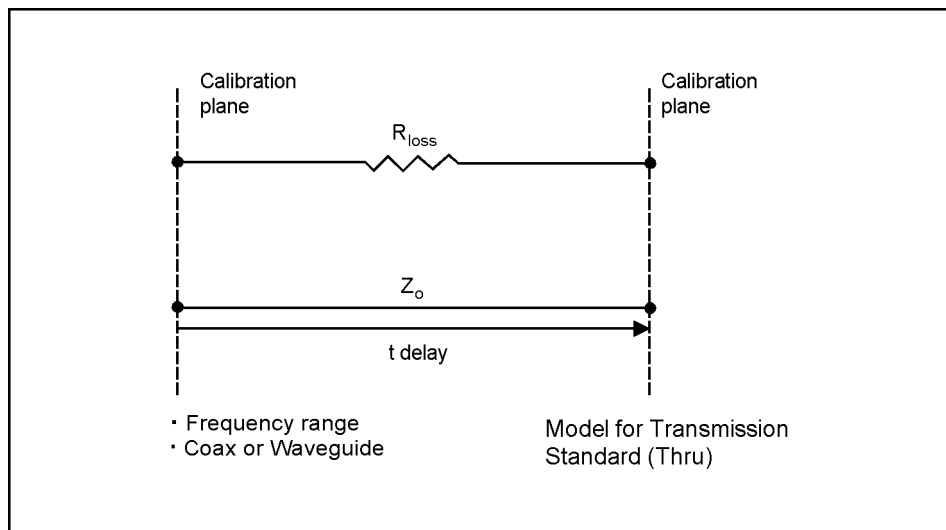

e5070aue005

**Z<sub>0</sub>** The offset impedance between the standard to be defined and the actual measurement plane. Normally, this is set to the characteristic impedance of the system.

**Delay** The delay occurs depending on the length of the transmission line between the standard to be defined and the actual measurement plane. In an OPEN, SHOT, or LOAD standard, the delay is defined as one-way propagation time (sec.) from the measurement plane to the standard. In a THRU standard, it is defined as one-way propagation time (sec.) from one measurement plane to the other. The delay can be

determined through measurement or by dividing the exact physical length of the standard by the velocity coefficient.

**Loss** This is used to determine the energy loss caused by the skin effect for the length (one-way) of the coaxial cable. Loss is defined using the unit of  $\Omega/s$  at 1 GHz. In many applications, using the value  $i0i$  for the loss should not result in significant errors. The loss of a standard is determined by measuring the delay (sec.) and the loss at 1 GHz and then substituting them in the formula below.

$$Loss\left(\frac{\Omega}{s}\right) = \frac{loss(dB) \times Z_0(\Omega)}{4.3429(dB) \times delay(s)}$$

**C0, C1, C2, C3** It is extremely rare for an OPEN standard to have perfect reflection characteristics at high frequencies. This is because the fringe capacitance of the standard causes a phase shift that varies along with the frequency. For internal calculation of the analyzer, an OPEN capacitance model is used. This model is described as a function of frequency, which is a polynomial of the third degree. Coefficients in the polynomial may be defined by the user. The formula for the capacitance model is shown below.

$$C = (C0) + (C1 \times F) + (C2 \times F^2) + (C3 \times F^3)$$

F: measurement frequency

C0 unit: (Farads) (constant in the polynomial)

C1 unit: (Farads/Hz)

C2 unit: (Farads/Hz<sup>2</sup>)

C3 unit: (Farads/Hz<sup>3</sup>)

**L0, L1, L2, L3** It is extremely rare for a SHORT standard to have perfect reflection characteristics at high frequencies. This is because the residual inductance of the standard causes a phase shift that varies along with the frequency. It is not possible to eliminate this effect. For internal calculation of the analyzer, a short-circuit inductance model is used. The model is described as a function of frequency, which is a polynomial of the third degree. Coefficients in the polynomial may be defined by the user. The formula for the inductance model is shown below.

$$L = (L0) + (L1 \times F) + (L2 \times F^2) + (L3 \times F^3)$$

F: Measurement frequency

L0 unit: [Farads] (the constant in the polynomial)

L1 unit: [Farads/Hz]

L2 unit: [Farads/Hz<sup>2</sup>]

L3 unit: [Farads/Hz<sup>3</sup>]

In most existing calibration kits, THRU standards are defined as “zero-length THRU,” i.e., the delay and loss are both “0”. Such a THRU standard does not exist, however. Calibration must be done with two test ports interconnected directly.

**NOTE**

The measurement accuracy depends on the conformity of the calibration standard to its definition. If the calibration standard has been damaged or worn out, the accuracy will decrease.

## Redefining a Calibration Kit

To change the definition of a calibration kit, follow the procedure below.

1. Select a calibration kit to be redefined.
2. Define the type of standard. Select one from among the OPEN, SHORT, LOAD, delay/THRU, and arbitrary impedance standards.
3. Define the standard coefficient.
4. Designate a standard class for the standard.
5. Save the data for the calibration kit that has been redefined.

### Redefining a Calibration Kit

**Step 1.** Press **Cal**.

**Step 2.** Press **Cal Kit**.

**Step 3.** Select the calibration kit to be redefined.

| Softkey           | Function                                  |
|-------------------|---|
| <b>85033E</b>     | Selects the “85033E” calibration kit.     |
| <b>85033D</b>     | Selects the “85033D” calibration kit.     |
| <b>85052D</b>     | Selects the “85052D” calibration kit.     |
| <b>85032F</b>     | Selects the “85032F” calibration kit.     |
| <b>85032B</b>     | Selects the “85032B” calibration kit.     |
| <b>85036B/E</b>   | Selects the “85036B/E” calibration kit.   |
| <b>85039B</b>     | Selects the “85039B” calibration kit.     |
| <b>85038A/F/M</b> | Selects the “85038A/F/M” calibration kit. |
| <b>User</b>       | Selects a user-defined calibration kit.   |
| <b>User</b>       | Selects a user-defined calibration kit.   |

---

#### NOTE

If the names (labels) of calibration kits were changed prior to operation, the new names will appear as respective softkeys.

**Step 4.** Press **Modify Cal Kit**.

**Step 5.** Press **Define STDs**.

**Step 6.** Select the standard to be redefined from among standards numbered 1 through 21.

**Step 7.** Press **STD Type**.

**Step 8.** Select a type of standard.

| Softkey           | Function                         |
|-------------------|----------------------------------|
| <b>Open</b>       | Selects the OPEN standard.       |
| <b>Short</b>      | Selects the SHORT standard.      |
| <b>Load</b>       | Selects the LOAD standard.       |
| <b>Delay/Thru</b> | Selects the delay/THRU standard. |
| <b>Arbitrary</b>  | Selects the arbitrary impedance. |
| <b>None</b>       | Selects no standard type.        |

**Step 9.** Set the standard coefficient.

| Softkey               | Function                     |
|-----------------------|------------------------------|
| <b>C0</b>             | Sets C0.                     |
| <b>C1</b>             | Sets C1.                     |
| <b>C2</b>             | Sets C2.                     |
| <b>C3</b>             | Sets C3.                     |
| <b>L0</b>             | Sets L0.                     |
| <b>L1</b>             | Sets L1.                     |
| <b>L2</b>             | Sets L2.                     |
| <b>L3</b>             | Sets L3.                     |
| <b>Offset Delay</b>   | Sets the offset delay.       |
| <b>Offset Z0</b>      | Sets the offset Z0.          |
| <b>Offset Loss</b>    | Sets the offset loss.        |
| <b>Arb. Impedance</b> | Sets an arbitrary impedance. |

**Step 10.** Press **Label** and input a new label for the standard using the keypad displayed on the screen.

**Step 11.** Press **Return**.

**Step 12.** Repeat Step 6 to Step 11 to redefine all standards for which changes are necessary.

**Step 13.** Press **Return**.

**Step 14.** Press **Specify CLSs**.

## Calibration

### Changing the Calibration Kit Definition

**Step 15.** Select the class to be redefined.

| Softkey | Function                 |
|---------|--------------------------|
| Open    | Selects the OPEN class.  |
| Short   | Selects the SHORT class. |
| Load    | Selects the LOAD class.  |
| Thru    | Selects the THRU class.  |

**Step 16.** Select a test port.

| Softkey | Function        |
|---------|-----------------|
| Port 1  | Selects port 1. |
| Port 2  | Selects port 2. |
| Port 3  | Selects port 3. |
| Port 4  | Selects port 4. |

---

**NOTE**

Select **Set All** to use the same standards for all test ports.

**Step 17.** Select the standards to be registered in the class from among standards numbered 1 through 21.

**Step 18.** Repeat Step 16 and Step 17 until classes are defined for all test ports that need to be redefined.

**Step 19.** Press **Return**.

**Step 20.** Repeat Step 15 to Step 19 to redefine all classes that need to be modified.

**Step 21.** Press **Return**.

**Step 22.** Press **Label Kit** and input a new label for the calibration kit using the keypad displayed on the screen.

## Default Settings of Pre-defined Calibration Kits

Calibration kits 85033E, 85033D, 85052D, 85032F, 85032B, and 85036B/E are pre-defined with default settings.

### 85033E

|   | 1. Short | 2. Open  | 3. Broadband | 4. Thru    |
|---|----------|----------|--------------|------------|
| <b>Label</b>                                      | Short    | Open     | Broadband    | Thru       |
| <b>STD Type</b>                                   | Short    | Open     | Load         | Delay/Thru |
| <b>C0</b> [ $\times 10^{-15}$ F]                  | 0        | 49.43    | 0            | 0          |
| <b>C1</b> [ $\times 10^{-27}$ F/Hz]               | 0        | -310.13  | 0            | 0          |
| <b>C2</b> [ $\times 10^{-36}$ F/Hz <sup>2</sup> ] | 0        | 23.17    | 0            | 0          |
| <b>C3</b> [ $\times 10^{-45}$ F/Hz <sup>3</sup> ] | 0        | -0.16    | 0            | 0          |
| <b>L0</b> [ $\times 10^{-12}$ H]                  | 2.0765   | 0        | 0            | 0          |
| <b>L1</b> [ $\times 10^{-24}$ H/Hz]               | -108.54  | 0        | 0            | 0          |
| <b>L2</b> [ $\times 10^{-33}$ H/Hz <sup>2</sup> ] | 2.1705   | 0        | 0            | 0          |
| <b>L3</b> [ $\times 10^{-42}$ H/Hz <sup>3</sup> ] | 0.01     | 0        | 0            | 0          |
| <b>Offset Delay</b> [s]                           | 31.808 p | 29.243 p | 0            | 0          |
| <b>Offset Z0</b> [ $\Omega$ ]                     | 50       | 50       | 50           | 50         |
| <b>Offset Loss</b> [ $\Omega$ /s]                 | 2.36 G   | 2.2 G    | 2.2 G        | 2.2 G      |
| <b>Arb. Impedance</b> [ $\Omega$ ]                | 50       | 50       | 50           | 50         |

### 85033D

|   | 1. Short | 2. Open  | 3. Broadband | 4. Thru    |
|---|----------|----------|--------------|------------|
| <b>Label</b>                                      | Short    | Open     | Broadband    | Thru       |
| <b>STD Type</b>                                   | Short    | Open     | Load         | Delay/Thru |
| <b>C0</b> [ $\times 10^{-15}$ F]                  | 0        | 49.43    | 0            | 0          |
| <b>C1</b> [ $\times 10^{-27}$ F/Hz]               | 0        | -310.13  | 0            | 0          |
| <b>C2</b> [ $\times 10^{-36}$ F/Hz <sup>2</sup> ] | 0        | 23.17    | 0            | 0          |
| <b>C3</b> [ $\times 10^{-45}$ F/Hz <sup>3</sup> ] | 0        | -0.16    | 0            | 0          |
| <b>L0</b> [ $\times 10^{-12}$ H]                  | 2.0765   | 0        | 0            | 0          |
| <b>L1</b> [ $\times 10^{-24}$ H/Hz]               | -108.54  | 0        | 0            | 0          |
| <b>L2</b> [ $\times 10^{-33}$ H/Hz <sup>2</sup> ] | 2.1705   | 0        | 0            | 0          |
| <b>L3</b> [ $\times 10^{-42}$ H/Hz <sup>3</sup> ] | 0.01     | 0        | 0            | 0          |
| <b>Offset Delay</b> [s]                           | 31.808 p | 29.243 p | 0            | 0          |
| <b>Offset Z0</b> [ $\Omega$ ]                     | 50       | 50       | 50           | 50         |
| <b>Offset Loss</b> [ $\Omega$ /s]                 | 2.36 G   | 2.2 G    | 2.2 G        | 2.2 G      |
| <b>Arb. Impedance</b> [ $\Omega$ ]                | 50       | 50       | 50           | 50         |

Calibration  
Changing the Calibration Kit Definition

85052D

|   | <b>1. Short</b>    | <b>2. Open</b>      | <b>5. 3.5/2.92</b> | <b>6. 3.5/SMA</b>  | <b>7. 2.92/SMA</b> |
|---|--------------------|---------------------|--------------------|--------------------|--------------------|
| <b>Label</b>                                      | Short              | Open                | 3.5/2.92           | 3.5/SMA            | 3.5/SMA            |
| <b>STD Type</b>                                   | Short              | Open                | Open               | Open               | Open               |
| <b>C0</b> [ $\times 10^{-15}$ F]                  | 0                  | 49.433              | 6.9558             | 5.9588             | 13.4203            |
| <b>C1</b> [ $\times 10^{-27}$ F/Hz]               | 0                  | -310.131            | -1.0259            | -11.195            | -1.9452            |
| <b>C2</b> [ $\times 10^{-36}$ F/Hz <sup>2</sup> ] | 0                  | 23.1682             | -0.01435           | 0.5076             | 0.5459             |
| <b>C3</b> [ $\times 10^{-45}$ F/Hz <sup>3</sup> ] | 0                  | -0.15966            | 0.0028             | -0.00243           | 0.01594            |
| <b>L0</b> [ $\times 10^{-12}$ H]                  | 2.0765             | 0                   | 0                  | 0                  | 0                  |
| <b>L1</b> [ $\times 10^{-24}$ H/Hz]               | -108.54            | 0                   | 0                  | 0                  | 0                  |
| <b>L2</b> [ $\times 10^{-33}$ H/Hz <sup>2</sup> ] | 2.1705             | 0                   | 0                  | 0                  | 0                  |
| <b>L3</b> [ $\times 10^{-42}$ H/Hz <sup>3</sup> ] | 0.01               | 0                   | 0                  | 0                  | 0                  |
| <b>Offset Delay</b> [s]                           | 31.785 p           | 29.243 p            | 0                  | 0                  | 0                  |
| <b>Offset Z0</b> [ $\Omega$ ]                     | 50                 | 50                  | 50                 | 50                 | 50                 |
| <b>Offset Loss</b> [ $\Omega$ /s]                 | 2.36 G             | 2.2 G               | 0                  | 0                  | 0                  |
| <b>Arb. Impedance</b> [ $\Omega$ ]                | 50                 | 50                  | 50                 | 50                 | 50                 |
|   | <b>8. 2.4/1.85</b> | <b>9. Broadband</b> | <b>11. Thru</b>    | <b>13. Adapter</b> |                    |
| <b>Label</b>                                      | 2.4/1.85           | Broadband           | Thru               | Adapter            |                    |
| <b>STD Type</b>                                   | Open               | Load                | Delay/Thru         | Delay/Thru         |                    |
| <b>C0</b> [ $\times 10^{-15}$ F]                  | 8.9843             | 0                   | 0                  | 0                  |                    |
| <b>C1</b> [ $\times 10^{-27}$ F/Hz]               | -13.9923           | 0                   | 0                  | 0                  |                    |
| <b>C2</b> [ $\times 10^{-36}$ F/Hz <sup>2</sup> ] | 0.3242             | 0                   | 0                  | 0                  |                    |
| <b>C3</b> [ $\times 10^{-45}$ F/Hz <sup>3</sup> ] | -0.00112           | 0                   | 0                  | 0                  |                    |
| <b>L0</b> [ $\times 10^{-12}$ H]                  | 0                  | 0                   | 0                  | 0                  |                    |
| <b>L1</b> [ $\times 10^{-24}$ H/Hz]               | 0                  | 0                   | 0                  | 0                  |                    |
| <b>L2</b> [ $\times 10^{-33}$ H/Hz <sup>2</sup> ] | 0                  | 0                   | 0                  | 0                  |                    |
| <b>L3</b> [ $\times 10^{-42}$ H/Hz <sup>3</sup> ] | 0                  | 0                   | 0                  | 0                  |                    |
| <b>Offset Delay</b> [s]                           | 0                  | 0                   | 0                  | 94.75 p            |                    |
| <b>Offset Z0</b> [ $\Omega$ ]                     | 50                 | 50                  | 50                 | 50                 |                    |
| <b>Offset Loss</b> [ $\Omega$ /s]                 | 0                  | 0                   | 0                  | 2.51 G             |                    |
| <b>Arb. Impedance</b> [ $\Omega$ ]                | 50                 | 50                  | 50                 | 50                 |                    |



85032F

|   | <b>1. Short(m)</b>  | <b>2. Open(m)</b> | <b>7. Short(f)</b>      | <b>8. Open(f)</b>       |
|---|---------------------|-------------------|-------------------------|-------------------------|
| <b>Label</b>  | Short(m)            | Open(m)           | Short(f)                | Open(f)                 |
| <b>STD Type</b>   | Short               | Open              | Short                   | Open                    |
| <b>C0 [<math>\times 10^{-15}</math> F]</b>                | 0                   | 89.939            | 0                       | 89.939                  |
| <b>C1 [<math>\times 10^{-27}</math> F/Hz]</b>             | 0                   | 2536.8            | 0                       | 2536.8                  |
| <b>C2 [<math>\times 10^{-36}</math> F/Hz<sup>2</sup>]</b> | 0                   | -264.99           | 0                       | -264.99                 |
| <b>C3 [<math>\times 10^{-45}</math> F/Hz<sup>3</sup>]</b> | 0                   | 13.4              | 0                       | 13.4                    |
| <b>L0 [<math>\times 10^{-12}</math> H]</b>                | 3.3998              | 0                 | 3.3998                  | 0                       |
| <b>L1 [<math>\times 10^{-24}</math> H/Hz]</b>             | -496.4808           | 0                 | -496.4808               | 0                       |
| <b>L2 [<math>\times 10^{-33}</math> H/Hz<sup>2</sup>]</b> | 34.8314             | 0                 | 34.8314                 | 0                       |
| <b>L3 [<math>\times 10^{-42}</math> H/Hz<sup>3</sup>]</b> | -0.7847             | 0                 | -0.7847                 | 0                       |
| <b>Offset Delay [s]</b>                                   | 45.955 p            | 41.19 p           | 45.955 p                | 40.8688 p               |
| <b>Offset Z0 [<math>\Omega</math>]</b>                    | 49.99               | 50                | 49.99                   | 50                      |
| <b>Offset Loss [<math>\Omega</math>/s]</b>                | 1.087 G             | 930 M             | 1.087 G                 | 930 M                   |
| <b>Arb. Impedance [<math>\Omega</math>]</b>               | 50                  | 50                | 50                      | 50                      |
|   | <b>9. Broadband</b> | <b>11. Thru</b>   | <b>13. (f/f)Adapter</b> | <b>14. (m/m)Adapter</b> |
| <b>Label</b>  | Broadband           | Thru              | (f/f)Adapter            | (m/m)Adapter            |
| <b>STD Type</b>   | Load                | Delay/Thru        | Delay/Thru              | Delay/Thru              |
| <b>C0 [<math>\times 10^{-15}</math> F]</b>                | 0                   | 0                 | 0                       | 0                       |
| <b>C1 [<math>\times 10^{-27}</math> F/Hz]</b>             | 0                   | 0                 | 0                       | 0                       |
| <b>C2 [<math>\times 10^{-36}</math> F/Hz<sup>2</sup>]</b> | 0                   | 0                 | 0                       | 0                       |
| <b>C3 [<math>\times 10^{-45}</math> F/Hz<sup>3</sup>]</b> | 0                   | 0                 | 0                       | 0                       |
| <b>L0 [<math>\times 10^{-12}</math> H]</b>                | 0                   | 0                 | 0                       | 0                       |
| <b>L1 [<math>\times 10^{-24}</math> H/Hz]</b>             | 0                   | 0                 | 0                       | 0                       |
| <b>L2 [<math>\times 10^{-33}</math> H/Hz<sup>2</sup>]</b> | 0                   | 0                 | 0                       | 0                       |
| <b>L3 [<math>\times 10^{-42}</math> H/Hz<sup>3</sup>]</b> | 0                   | 0                 | 0                       | 0                       |
| <b>Offset Delay [s]</b>                                   | 0                   | 0                 | 339 p                   | 339 p                   |
| <b>Offset Z0 [<math>\Omega</math>]</b>                    | 50                  | 50                | 50                      | 50                      |
| <b>Offset Loss [<math>\Omega</math>/s]</b>                | 0                   | 0                 | 2.2 G                   | 2.2 G                   |
| <b>Arb. Impedance [<math>\Omega</math>]</b>               | 50                  | 50                | 50                      | 50                      |

**NOTE**

(m) and (f) in the name (label) of the standard indicate male (m) and female (f) of the connector of the analyzer, respectively.

Calibration  
Changing the Calibration Kit Definition

85032B/E

|   | <b>1. Short(m)</b> | <b>2. Open(m)</b> | <b>3. Broadband</b> | <b>4. Thru</b> |
|---|--------------------|-------------------|---------------------|----------------|
| <b>Label</b>                                      | Short(m)           | Open(m)           | Broadband           | Thru           |
| <b>STD Type</b>                                   | Short              | Open              | Load                | Delay/Thru     |
| <b>C0</b> [ $\times 10^{-15}$ F]                  | 0                  | 119.09            | 0                   | 0              |
| <b>C1</b> [ $\times 10^{-27}$ F/Hz]               | 0                  | -36.955           | 0                   | 0              |
| <b>C2</b> [ $\times 10^{-36}$ F/Hz <sup>2</sup> ] | 0                  | 26.258            | 0                   | 0              |
| <b>C3</b> [ $\times 10^{-45}$ F/Hz <sup>3</sup> ] | 0                  | 5.5136            | 0                   | 0              |
| <b>L0</b> [ $\times 10^{-12}$ H]                  | 0                  | 0                 | 0                   | 0              |
| <b>L1</b> [ $\times 10^{-24}$ H/Hz]               | 0                  | 0                 | 0                   | 0              |
| <b>L2</b> [ $\times 10^{-33}$ H/Hz <sup>2</sup> ] | 0                  | 0                 | 0                   | 0              |
| <b>L3</b> [ $\times 10^{-42}$ H/Hz <sup>3</sup> ] | 0                  | 0                 | 0                   | 0              |
| <b>Offset Delay</b> [s]                           | 93 f               | 0                 | 0                   | 0              |
| <b>Offset Z0</b> [ $\Omega$ ]                     | 49.992             | 50                | 50                  | 50             |
| <b>Offset Loss</b> [ $\Omega$ /s]                 | 700 M              | 700 M             | 700 M               | 700 M          |
| <b>Arb. Impedance</b> [ $\Omega$ ]                | 50                 | 50                | 50                  | 50             |
|   | <b>7. Short(f)</b> | <b>8. Open(f)</b> |                     |                |
| <b>Label</b>                                      | Short(f)           | Open(f)           |                     |                |
| <b>STD Type</b>                                   | Short              | Open              |                     |                |
| <b>C0</b> [ $\times 10^{-15}$ F]                  | 0                  | 62.14             |                     |                |
| <b>C1</b> [ $\times 10^{-27}$ F/Hz]               | 0                  | -143.07           |                     |                |
| <b>C2</b> [ $\times 10^{-36}$ F/Hz <sup>2</sup> ] | 0                  | 82.92             |                     |                |
| <b>C3</b> [ $\times 10^{-45}$ F/Hz <sup>3</sup> ] | 0                  | 0.76              |                     |                |
| <b>L0</b> [ $\times 10^{-12}$ H]                  | 0                  | 0                 |                     |                |
| <b>L1</b> [ $\times 10^{-24}$ H/Hz]               | 0                  | 0                 |                     |                |
| <b>L2</b> [ $\times 10^{-33}$ H/Hz <sup>2</sup> ] | 0                  | 0                 |                     |                |
| <b>L3</b> [ $\times 10^{-42}$ H/Hz <sup>3</sup> ] | 0                  | 0                 |                     |                |
| <b>Offset Delay</b> [s]                           | 17.817 p           | 17.411 p          |                     |                |
| <b>Offset Z0</b> [ $\Omega$ ]                     | 50.209             | 50                |                     |                |
| <b>Offset Loss</b> [ $\Omega$ /s]                 | 2.1002 G           | 700 M             |                     |                |
| <b>Arb. Impedance</b> [ $\Omega$ ]                | 50                 | 50                |                     |                |

**NOTE**

(m) and (f) in the name (label) of the standard indicate male (m) and female (f) of the connector of the analyzer, respectively.

**85036B/E**

|   | <b>1. Short(m)</b> | <b>2. Open(m)</b> | <b>3. Broadband</b> | <b>4. Thru</b> |
|---|--------------------|-------------------|---------------------|----------------|
| <b>Label</b>                                      | Short(m)           | Open(m)           | Broadband           | Thru           |
| <b>STD Type</b>                                   | Short              | Open              | Load                | Delay/Thru     |
| <b>C0</b> [ $\times 10^{-15}$ F]                  | 0                  | 63.5              | 0                   | 0              |
| <b>C1</b> [ $\times 10^{-27}$ F/Hz]               | 0                  | 84                | 0                   | 0              |
| <b>C2</b> [ $\times 10^{-36}$ F/Hz <sup>2</sup> ] | 0                  | 56                | 0                   | 0              |
| <b>C3</b> [ $\times 10^{-45}$ F/Hz <sup>3</sup> ] | 0                  | 0                 | 0                   | 0              |
| <b>L0</b> [ $\times 10^{-12}$ H]                  | 0                  | 0                 | 0                   | 0              |
| <b>L1</b> [ $\times 10^{-24}$ H/Hz]               | 0                  | 0                 | 0                   | 0              |
| <b>L2</b> [ $\times 10^{-33}$ H/Hz <sup>2</sup> ] | 0                  | 0                 | 0                   | 0              |
| <b>L3</b> [ $\times 10^{-42}$ H/Hz <sup>3</sup> ] | 0                  | 0                 | 0                   | 0              |
| <b>Offset Delay</b> [s]                           | 0                  | 0                 | 0                   | 0              |
| <b>Offset Z0</b> [ $\Omega$ ]                     | 75                 | 75                | 75                  | 75             |
| <b>Offset Loss</b> [ $\Omega$ /s]                 | 1.13 G             | 1.13 G            | 1.13 G              | 1.13 G         |
| <b>Arb. Impedance</b> [ $\Omega$ ]                | 50                 | 50                | 75                  | 50             |
|   | <b>7. Short(f)</b> | <b>8. Open(f)</b> |                     |                |
| <b>Label</b>                                      | Short(f)           | Open(f)           |                     |                |
| <b>STD Type</b>                                   | Short              | Open              |                     |                |
| <b>C0</b> [ $\times 10^{-15}$ F]                  | 0                  | 41                |                     |                |
| <b>C1</b> [ $\times 10^{-27}$ F/Hz]               | 0                  | 40                |                     |                |
| <b>C2</b> [ $\times 10^{-36}$ F/Hz <sup>2</sup> ] | 0                  | 5                 |                     |                |
| <b>C3</b> [ $\times 10^{-45}$ F/Hz <sup>3</sup> ] | 0                  | 0                 |                     |                |
| <b>L0</b> [ $\times 10^{-12}$ H]                  | 0                  | 0                 |                     |                |
| <b>L1</b> [ $\times 10^{-24}$ H/Hz]               | 0                  | 0                 |                     |                |
| <b>L2</b> [ $\times 10^{-33}$ H/Hz <sup>2</sup> ] | 0                  | 0                 |                     |                |
| <b>L3</b> [ $\times 10^{-42}$ H/Hz <sup>3</sup> ] | 0                  | 0                 |                     |                |
| <b>Offset Delay</b> [s]                           | 17.544 p           | 17.544 p          |                     |                |
| <b>Offset Z0</b> [ $\Omega$ ]                     | 75                 | 75                |                     |                |
| <b>Offset Loss</b> [ $\Omega$ /s]                 | 1.13 G             | 1.13 G            |                     |                |
| <b>Arb. Impedance</b> [ $\Omega$ ]                | 50                 | 50                |                     |                |

**NOTE** (m) and (f) in the name (label) of the standard indicate male (m) and female (f) of the connector of the analyzer, respectively.

Calibration  
**Changing the Calibration Kit Definition**

**85039B**

|   | <b>1. Short (m)</b> | <b>2. Open (m)</b> | <b>3. Broadband</b> | <b>4. Thru</b> |
|---|---------------------|--------------------|---------------------|----------------|
| <b>Label</b>                                | Short (m)           | Open (m)           | Broadband           | Thru           |
| <b>STD Type</b>                             | Short               | Open               | Load                | Delay/Thru     |
| C0 [ $\times 10^{-15}$ F]                   | 0                   | 42.945             | 0                   | 0              |
| C1 [ $\times 10^{-27}$ F/Hz]                | 0                   | 98.367             | 0                   | 0              |
| C2 [ $\times 10^{-36}$ F/Hz <sup>2</sup> ]  | 0                   | 706.93             | 0                   | 0              |
| C3 [ $\times 10^{-45}$ F/Hz <sup>3</sup> ]  | 0                   | -114.957           | 0                   | 0              |
| L0 [ $\times 10^{-12}$ H]                   | 0                   | 0                  | 0                   | 0              |
| L1 [ $\times 10^{-24}$ H/Hz]                | 0                   | 0                  | 0                   | 0              |
| L2 [ $\times 10^{-33}$ H/Hz <sup>2</sup> ]  | 0                   | 0                  | 0                   | 0              |
| L3 [ $\times 10^{-42}$ H/Hz <sup>3</sup> ]  | 0                   | 0                  | 0                   | 0              |
| <b>Offset Delay [s]</b>                     | 57.0 p              | 53.6 p             | 0                   | -129.0 p       |
| <b>Offset Z0 [<math>\Omega</math>]</b>      | 75                  | 75                 | 75                  | 75             |
| <b>Offset Loss [<math>\Omega</math>/s]</b>  | 1.80 G              | 1.64 G             | 1.13 G              | 1.13 G         |
| <b>Arb. Impedance [<math>\Omega</math>]</b> | 75                  | 75                 | 75                  | 75             |

**NOTE**

(m) and (f) in the name (label) of the standard indicate male (m) and female (f) of the connector of the analyzer, respectively.

**85038A/F/M**

|   | <b>1. Short</b> | <b>2. Open</b> | <b>3. Broadband</b> | <b>4. Thru</b> |
|---|-----------------|----------------|---------------------|----------------|
| <b>Label</b>                                | Short           | Open           | Broadband           | Thru           |
| <b>STD Type</b>                             | Short           | Open           | Load                | Delay/Thru     |
| C0 [ $\times 10^{-15}$ F]                   | 0               | 32.0           | 0                   | 0              |
| C1 [ $\times 10^{-27}$ F/Hz]                | 0               | 100            | 0                   | 0              |
| C2 [ $\times 10^{-36}$ F/Hz <sup>2</sup> ]  | 0               | -50.0          | 0                   | 0              |
| C3 [ $\times 10^{-45}$ F/Hz <sup>3</sup> ]  | 0               | 100            | 0                   | 0              |
| L0 [ $\times 10^{-12}$ H]                   | 0               | 0              | 0                   | 0              |
| L1 [ $\times 10^{-24}$ H/Hz]                | 0               | 0              | 0                   | 0              |
| L2 [ $\times 10^{-33}$ H/Hz <sup>2</sup> ]  | 0               | 0              | 0                   | 0              |
| L3 [ $\times 10^{-42}$ H/Hz <sup>3</sup> ]  | 0               | 0              | 0                   | 0              |
| <b>Offset Delay [s]</b>                     | 66.734 p        | 66.734 p       | 0                   | 0              |
| <b>Offset Z0 [<math>\Omega</math>]</b>      | 50              | 50             | 50                  | 50             |
| <b>Offset Loss [<math>\Omega</math>/s]</b>  | 0.63 G          | 0.63 G         | 0                   | 0              |
| <b>Arb. Impedance [<math>\Omega</math>]</b> | 50              | 50             | 50                  | 50             |

---

## **5 Making Measurements**

This chapter describes how to carry out measurements with the Agilent E5061A/E5062A by using the trigger function.

---

## Setting Up the Trigger and Making Measurements

The E5061A/E5062A has one trigger source. When this trigger source detects a trigger signal that has occurred, a sweep is performed for channels that were “Initiate” state in the order from channel 1 to channel 16. You set the “Initiate” or “Idle” status of each channel as the trigger mode. For details about the trigger system, refer to *Programmer's Guide*.

---

### NOTE

The execution of measurement for each channel does not depend on how the channel is displayed. Channels that have been started up can be used for measurement even if they are not displayed.

For each channel, a sweep is performed only for stimulus ports required to update parameters of the displayed trace.

---

### Sweep Order in Each Channel

In a channel, each test port is set to stimulus port in the order of port number and updates each trace (Table 5-1).

Table 5-1

Sweep Order in Each Channel

| Sweep Order | Stimulus Port | Updated Trace    |
|-------------|---------------|------------------|
| ↓           | Port 1        | $S_{11}, S_{21}$ |
|             | Port 2        | $S_{12}, S_{22}$ |

---

### NOTE

If full 2, 3, or 4 port error correction is valid, any traces related to the calibrated ports are not updated before the last calibrated port is swept as a stimulus port.

Sweep is not executed for the stimulus port which is not required for updating traces.

---

## Trigger Source

The trigger source generates a cue signal that initiates a measurement process. Four types of trigger sources are available as shown in Table 5-2.

**Table 5-2** Trigger Sources and Their Functions

| Trigger Sources              | Function   |
|------------------------------|--|
| Internal ( <b>Internal</b> ) | Uses a consecutive signal generated by the firmware as a trigger source. Triggers are sent immediately following the completion of each measurement. |
| External ( <b>External</b> ) | Uses the external trigger input terminal (BNC) as a trigger source.  |
| Manual ( <b>Manual</b> )     | A trigger will be generated by pressing <span style="border: 1px solid black; padding: 2px;">Trigger</span> - <b>Trigger</b> .                       |
| Bus ( <b>Bus</b> )           | A trigger will be generated by executing a <b>*TRG</b> command.  |

## Trigger Modes

You can set the trigger mode for each channel independently. You can control the operation of each channel when a trigger signal is detected by setting the status of each channel as the trigger mode.

**Table 5-3** Trigger mode

| Trigger mode name                      | Function   |
|--|--|
| Sweep stop ( <b>Hold</b> )             | The status (“Idle” status) in which the sweep is stopped. When a trigger signal is detected, the sweep is not performed.   |
| Single sweep ( <b>Single</b> )         | An “Initiate” status. When a trigger signal is detected, a sweep is performed. After completion of the sweep, the “Idle” status occurs.  |
| Continuous sweep ( <b>Continuous</b> ) | An “Initiate” status. When a trigger signal is detected, the sweep is performed. After completion of the sweep, the “Initiate” status is kept. The sweep is repeated each time a trigger signal is detected. |

## Setting Up the Trigger and Making Measurements

### 1. Selecting a Trigger Source

Follow the procedure below to select a trigger source.

- Step 1.** Press **Trigger**
- Step 2.** Press **Trigger Source**
- Step 3.** Press the softkey that corresponds to the desired trigger source.

| Softkey         | Function                             |
|-----------------|--------------------------------------|
| <b>Internal</b> | Selects the internal trigger source. |
| <b>External</b> | Selects the external trigger source. |
| <b>Manual</b>   | Selects the manual trigger source.   |
| <b>Bus</b>      | Selects the bus trigger source.      |

### 2. Selecting a Trigger Mode

Follow the procedure below to select a trigger mode.

- Step 1.** Press **Channel Next** (or **Channel Prev**) to select a channel for which the trigger mode will be set.
- Step 2.** Press **Trigger**.
- Step 3.** Press the softkey that corresponds to the desired trigger mode.

| Softkey                         | Function   |
|---------------------------------|--|
| <b>Hold</b>                     | Sets the active channel trigger mode to the hold sweep mode  |
| <b>Single</b>                   | Sets the active channel trigger mode to the single sweep mode.   |
| <b>Continuous</b>               | Sets the active channel trigger mode to the continuous sweep mode.   |
| <b>Hold All Channels</b>        | Sets all channel trigger modes to the hold sweep mode.   |
| <b>Continuous Disp Channels</b> | Sets trigger modes of all displayed channels ( <b>Display</b> - <b>Display</b> ) to the continuous sweep mode. |

- Step 4.** Repeat Step 1 to Step 3 until all channels are set for the respective trigger mode.

### 3. Generating the Trigger

Next, it is necessary to generate a trigger using the trigger source selected in “1. Selecting a Trigger Source” on page 122.

#### NOTE

Once the internal trigger source is selected, a series of triggers will be continuously generated as soon as the setting becomes effective.

Pressing **Trigger** - **Restart** during a sweep forces the analyzer to abort the sweep.



---

## **6** **Data Analysis**

This chapter explains how to use the analytical functions of the Agilent E5061A/E5062A.

## Analyzing Data on the Trace Using the Marker

### About Marker Functions

The marker can be used in the following ways:

- Reading a measured value as numerical data (as an absolute value or a relative value from the reference point)
- Moving the marker to a specific point on the trace (marker search)
- Analyzing trace data to determine a specific parameter
- Using the value of the marker to change the stimulus (sweep range) and scale (value of the reference line)

For the procedure to change the sweep range and scale by using the marker, refer to “Setting the Sweep Range Using the Marker” on page 58 and “Setting the Value of a Reference Line Using the Marker” on page 72.

The E5061A/E5062A is capable of displaying up to 10 markers on each trace. Each marker has a stimulus value (the value on the X-axis in rectangular display format) and a response value (the value on the Y-axis in rectangular display format). The Smith chart and polar formats each have two marker response values (log amplitude and phase).

Although marker values are usually displayed for the active (operable) trace, you can also display all marker values for displayed traces. For more information, see “Displaying all marker values for displayed traces” on page 134.

## Reading Values on the Trace

You can read the value of a marker displayed on the trace.

In rectangular display format, the marker response value is always in the same data format as that of the Y-axis. On the contrary, one format for the marker response values (two values: main and auxiliary) can be selected from among several types. The selection is performed in the data format.

**Table 6-1**

**Marker Response Values for Smith Chart/Polar Data Formats**

| Softkey for selecting the data format | Marker response value |                           |
|---------------------------------------|-----------------------|---------------------------|
|                                       | Main                  | Auxiliary                 |
| Smith - Lin / Phase                   | Linear amplitude      | Phase                     |
| Smith - Log / Phase                   | Log amplitude         | Phase                     |
| Smith - Real / Imag                   | Real component        | Imaginary component       |
| Smith - R + jX                        | Resistance            | Reactance <sup>*1</sup>   |
| Smith - G + jB                        | Conductance           | Susceptance <sup>*1</sup> |
| Polar - Lin / Phase                   | Linear amplitude      | Phase                     |
| Polar - Log / Phase                   | Log amplitude         | Phase                     |
| Polar - Real / Imag                   | Real component        | Imaginary component       |

\*1. The inductance or capacitance is also displayed.

For setting up data formats, refer to “Selecting a Data Format” on page 69.

### Reading a Value on the Trace

- Step 1.** Press **Channel Next** or **Channel Prev** to activate the channel on which a marker is used.
- Step 2.** Press **Trace Next** or **Trace Prev** to activate the channel on which a marker is used.
- Step 3.** Press **Marker**.

**NOTE**

At this point in time, marker 1 is turned on and becomes active (you can operate the marker). When using marker 1, you can omit Step 4.

- Step 4.** Select a marker and turn it on. The softkey used to turn on a marker is used to activate that marker.

| Softkey                        | Function  |
|--------------------------------|---|
| <b>Marker 1</b>                | Turn on marker 1, which has been turned off; activate marker 1.                         |
| <b>Marker 2</b>                | Turn on marker 2, which has been turned off; activate marker 2.                         |
| <b>Marker 3</b>                | Turn on marker 3, which has been turned off; activate marker 3.                         |
| <b>Marker 4</b>                | Turn on marker 4, which has been turned off; activate marker 4.                         |
| <b>More Markers - Marker 5</b> | Turn on marker 5, which has been turned off; activate marker 5.                         |
| <b>More Markers - Marker 6</b> | Turn on marker 6, which has been turned off; activate marker 6.                         |
| <b>More Markers - Marker 7</b> | Turn on marker 7, which has been turned off; activate marker 7.                         |
| <b>More Markers - Marker 8</b> | Turn on marker 8, which has been turned off; activate marker 8.                         |
| <b>More Markers - Marker 9</b> | Turn on marker 9, which has been turned off; activate marker 9.                         |
| <b>Ref Marker</b>              | Turn on the reference marker, which has been turned off; activate the reference marker. |

- Step 5.** Change the marker stimulus value in the entry area. This operation enables you to move the marker to a point on the desired trace.





The value in the entry area can be changed by one of the following methods.



---

**NOTE**

---

To change the value in the entry area, the figure in the box should be highlighted. If the figure is not highlighted, press the softkey for the marker you are using (**marker 1 to marker 9, Ref Marker**), or **Focus** to highlight the figure.

- Enter a numeric value using the ENTRY block key on the front panel.
- Turn the rotary knob () on the front panel.
- Press the up or down arrow key ( ) on the front panel.
- Using the mouse, click one of the buttons ( ) on the right side of the entry area.

You can move the marker by dragging and dropping either one of the marker position pointers above and below the graph ( ) (pressing the button on the object to be moved and releasing the button on the destination). In rectangular display format, you can move a marker itself by dragging and dropping it.

- Step 6.** When using other markers, repeat Step 4 and Step 5.
- Step 7.** Read the marker stimulus value and marker response value displayed in the upper-left part of the trace screen.

**Step 8.** To turn off marker(s), press the **Clear Marker Menu** and then press one of the softkeys as follows:

| <b>Softkey</b>              | <b>Function</b>   |
|-----------------------------|---|
| <b>All OFF</b>              | Turns off all of the markers on the active trace.             |
| <b>Marker 1 to Marker 9</b> | Turns off one of the markers 1 through 9 on the active trace. |
| <b>Ref Marker</b>           | Turns off the reference markers on the active trace.          |

---

**NOTE**

In the preset configuration, the marker settings on traces in a channel are coupled (Marker Couple is turned on). For marker coupling, refer to “Setting Up Markers for Each Trace/Setting Up Markers for Coupled Operations Between Traces” on page 130.

---

## Reading the Relative Value From the Reference Point on the Trace

You can convert the marker reading into a relative value from the reference point.

Figure 6-1 Delta marker mode

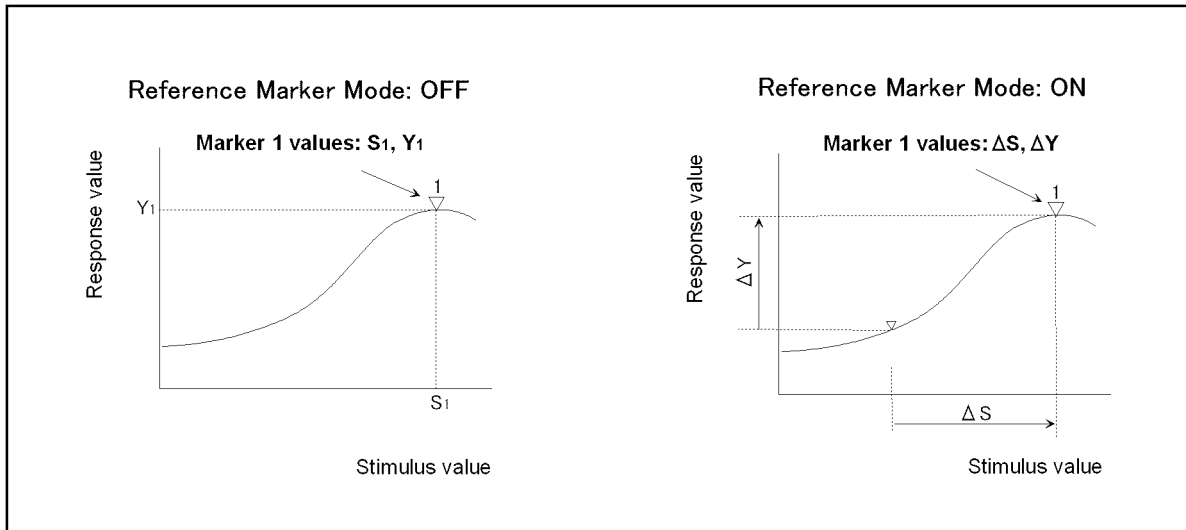

e5070aue121

### Converting From a Reference Point to a Relative Value

- Step 1.** Following Step 1 to Step 5 in “Reading Values on the Trace” on page 125, place the reference marker on the point to be used as the reference.
- Step 2.** Press **Ref Marker Mode** to turn on the reference mode.

With the reference mode turned on, the stimulus values and response values are indicated in relative values referred to by the position of the reference marker.

- Step 3.** Following Step 4 to Step 5 in “Reading Values on the Trace” on page 125, place markers 1 through 9 on the desired points to read the values.

---

#### NOTE

Pressing **Marker** → **Ref Marker** enables you to place the reference marker at the position of the currently active marker. The reference mode will then turn on automatically.

---

## Reading Only the Actual Measurement Point/Reading the Value Interpolated Between Measurement Points

The point on the trace on which a marker can be placed differs depending on how the discrete marker mode is set up.

### Turning on discrete mode (Discrete ON)

A marker moves only between actual measurement points. When a specific marker stimulus value is specified as a numerical value, the marker is placed at the measurement point closest to the specified value. A marker that is placed between interpolated points with the discrete mode off automatically moves to the nearest measurement point when the discrete mode turns on.

### Turning off discrete mode (Discrete OFF)

The marker can move from one actual measurement point to another. Because it is interpolated, it can also move in the space between measurement points.

Figure 6-2

### Marker Discrete Mode

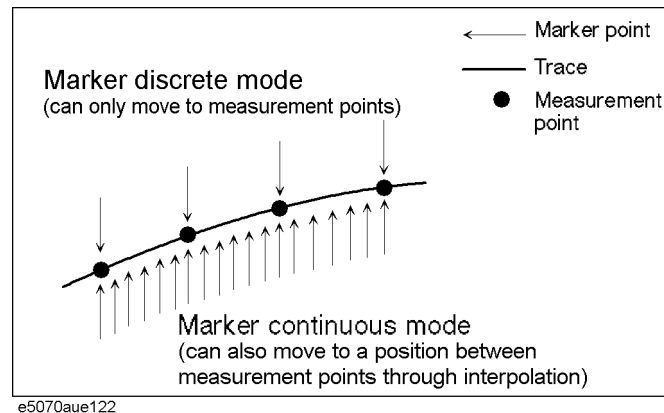

### Turning Discrete Mode On or Off

- Step 1.** Press **Channel Next** (or **Channel Prev**) and **Trace Next** (or **Trace Prev**) to activate the trace on which the discrete mode is set up.
- Step 2.** Press **Marker Fctn**.
- Step 3.** Press **Discrete** to turn the discrete mode on or off.

## Setting Up Markers for Each Trace/Setting Up Markers for Coupled Operations Between Traces

The setting up and moving of markers can be performed either in coupled operation for all traces in a channel or independently for each trace.

Figure 6-3

### Marker Coupling

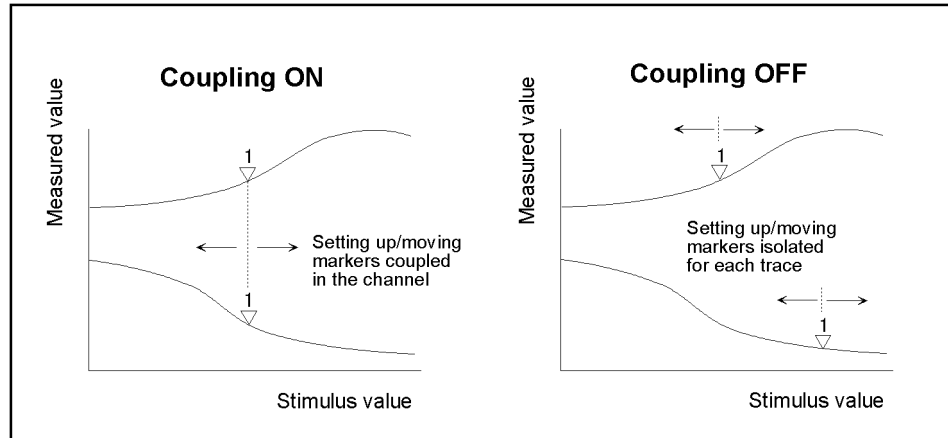

e5070aue049

**Marker Couple is on.  
(Coupling ON)**

The setting up and moving of markers is performed in coupled operation on all traces in a channel.

**Marker Couple is off.  
(Coupling OFF)**

The setting up and moving of markers is performed independently for each trace.

### Turning Marker Coupling On or Off

- Step 1.** Press **Channel Next** (or **Channel Prev**) to activate the channel on which the marker couple will be set.
- Step 2.** Press **Marker Fctn**.
- Step 3.** Press **Couple** to turn the marker coupling on or off.



## Listing All the Marker Values in All the Channels Displayed

You can list all the marker values in all the displayed channels on the screen.

### Turning On the Marker Table Display

**Step 1.** Press **Marker Fctn**.

**Step 2.** Press **Marker Table** to turn on the marker table display.

The marker table appears in the lower part of the screen. (See Figure 6-4.)

Figure 6-4

### Marker Table ON

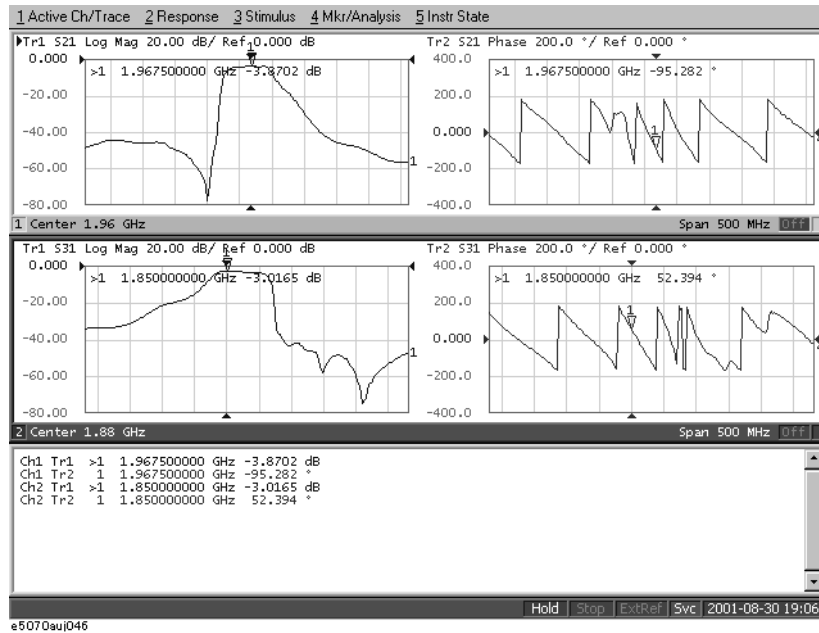

## Specifying the display position of marker values

This section describes how to specify the marker value display position as a percentage for each active trace.

Figure 6-5

### Marker coupling

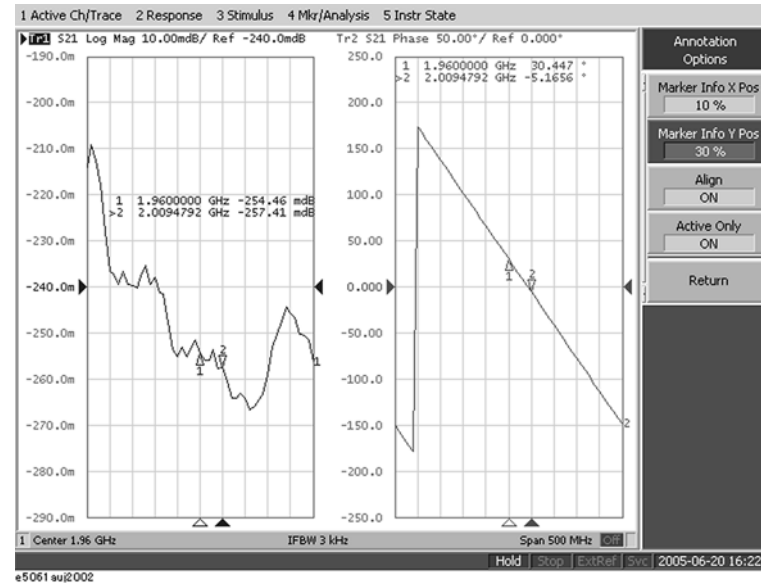

**Marker Info X Pos** Specifies the horizontal display position by the width of the display area as a percentage.

**Marker Info Y Pos** Specifies the vertical display position by the height of the display area as a percentage.

### Operational procedure

- Step 1.** Press **Channel Next** (or **Channel Prev**) to activate the channel for which you want to set marker coupling.
- Step 2.** Press **Marker Fctn**.
- Step 3.** Press **Annotation Options**.
- Step 4.** Press **Marker Info X Pos** to set the horizontal display position.
- Step 5.** Press **Marker Info Y Pos** to set the vertical display position.

## Aligning maker value displays

This section describes how to align maker value displays.

Figure 6-6

### Marker coupling

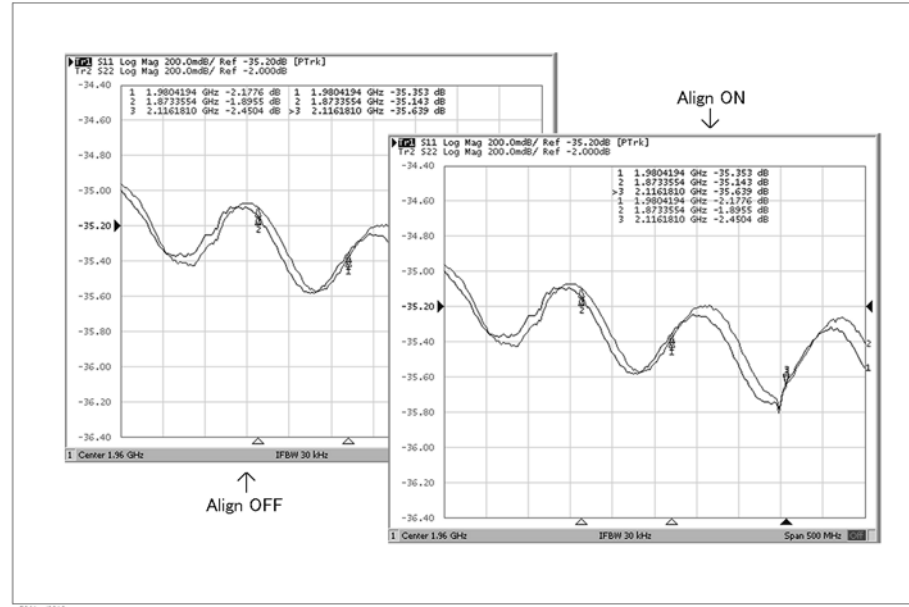

**On**  
(Align ON)

Displays marker values to align to the display position of trace 1.

**Off**  
(Align OFF)

Displays marker values in the display position defined for each trace.

### Operational procedure

- Step 1. Press **Marker Fctn**.
- Step 2. Press **Annotation Options**.
- Step 3. Press **Align** to toggle on/off.

## Displaying all marker values for displayed traces

This section describes how to display all marker values for displayed traces.

Figure 6-7

### Marker coupling

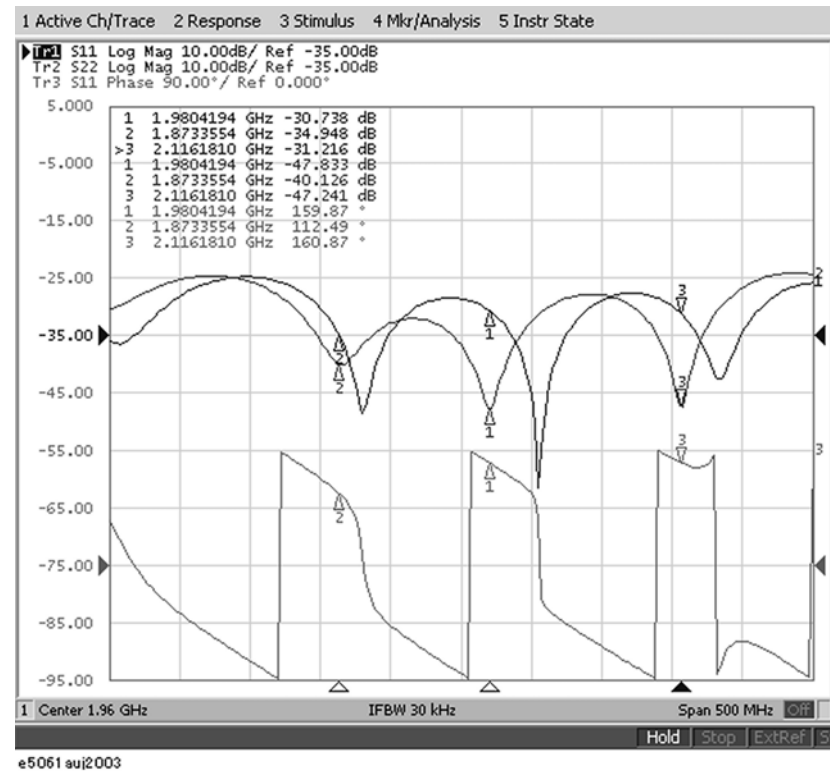

**Display all (Active Only OFF)** Displays all marker values for displayed traces.

**Displays active markers (Active Only ON)** Displays markers for the active trace only.

### Operational procedure

- Step 1. Press **Marker Fctn**.
- Step 2. Press **Annotation Options**.
- Step 3. Press **Active Only** to toggle on/off.

---

## Searching for Positions that Match Specified Criteria

You can search for a position that matches your specified criteria using the Marker Search feature.

Marker Search allows you to search for a position that matches the following criteria.

- Maximum value
- Minimum value
- Target (a point that has a target measurement value)
  - Target nearest to the marker position
  - Target nearest to the left-hand side of the marker position
  - Target nearest to the right-hand side of the marker position
- Peak
  - Maximum peak (for a positive peak), minimum peak (for a negative peak)
  - Peak nearest to the left-hand side of the marker position
  - Peak nearest to the right-hand side of the marker position

### Setting Search Range

The Marker Search feature allows you to set part of the sweep range as the search target (Partial Search feature) as well as the entire search range. For the Partial Search feature, you can select whether to couple traces in the channel.

#### Procedure to turn on/off trace coupling within search range

- Step 1.** Press **Channel Next** or **Channel Prev** to activate a channel for which you want to set the search range.
- Step 2.** Press **Trace Next** or **Trace Prev** to activate a trace for which you want to set the search range.
- Step 3.** Press **Marker Search**.
- Step 4.** Press **Search Range**.
- Step 5.** Press **Couple** to toggle on/off the trace coupling within the search range.

**Procedure to set search range**

- Step 1.** Press **Channel Next** or **Channel Prev** to activate a channel for which you want to set the search range.
- Step 2.** If the trace coupling within the search range is off, press **Trace Next** or **Trace Prev** to activate a trace for which you want to set the search range.
- Step 3.** Press **Marker Search**.
- Step 4.** Press **Search Range**.
- Step 5.** Press **Search Range** to turn on the Partial Search feature.
- Step 6.** Press **Start**.
- Step 7.** Enter the start value (lower limit) of the search range using the ENTRY block keys on the front panel.
- Step 8.** Press **Stop**.
- Step 9.** Enter the stop value (upper limit) of the search range using the ENTRY block keys on the front panel.

**Automatically Executing a Search Each Time a Sweep is Done (Search Tracking)**

Search tracking is a function that causes a search to be repeated every time a sweep is done even if the execution key for the search (maximum, minimum, peak, and target) is not pressed. This function facilitates that measurement dispersion be observed, such as the maximum value of traces (e.g., the insertion loss of a band pass filter).

**Performing Search Tracking**

- Step 1.** Press **Channel Next** (or **Channel Prev**) and **Trace Next** (or **Trace Prev**) to activate the trace on which search tracking is set up.
- Step 2.** Press **Marker Search**.
- Step 3.** Press **Tracking**, and turn the search tracking function on or off.

### Searching for the Maximum and Minimum Measured Values

You can search for the maximum or minimum measured value on the trace and move a marker to that point. (See Figure 6-8.)

Figure 6-8

Searching for the Maximum and Minimum Measured Values

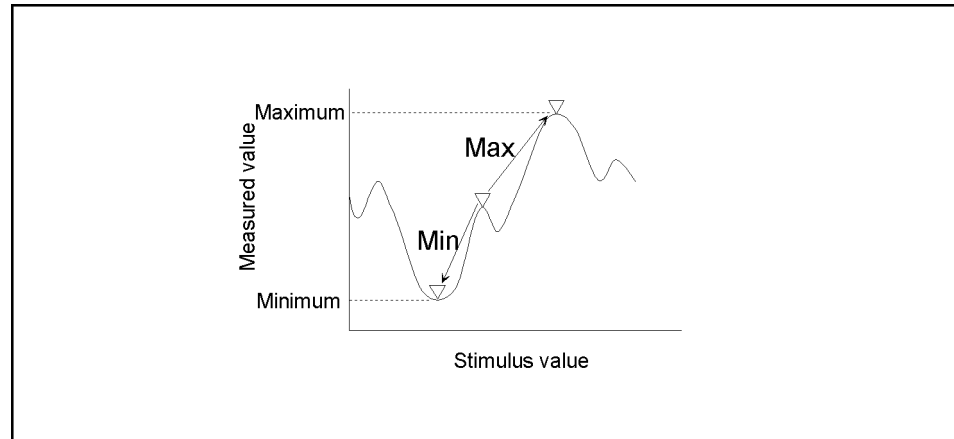

e5070aue047

**Search for the maximum (Max)** Move the active marker to the point on the trace where the measured value is greatest.

**Search for the minimum (Min)** Move the active marker to the point on the trace where the measured value is lowest.

### Searching for Maximum and Minimum Values

- Step 1.** Following Step 1 to Step 4 in “Reading Values on the Trace” on page 125, activate the marker you are using to search for the maximum and minimum values.
- Step 2.** Press **Marker Search**.
- Step 3.** Press the corresponding softkey to move the marker to the maximum or minimum measured value.

| Softkey    | Function                                |
|------------|---|
| <b>Max</b> | Perform a search for the maximum value. |
| <b>Min</b> | Perform a search for the minimum value. |

**NOTE**

When the data format is in Smith chart or polar format, execute the search for the main response value of the two marker response values.

## Searching for the Target Value (Target Search)

The target search function enables you to move the marker to the point having the target measured value.

### Target and Transition Types

A target is a point that has a specific measured value on the trace. Targets can be divided into the two groups shown below depending on their transition type.

**Transition type: Positive (Positive)** When the value of the target is larger than the measured value that immediately precedes (on the left)

**Transition type: Negative (Negative)** When the value of the target is smaller than the measured value that precedes immediately (on the left)

Figure 6-9

### Target and Transition Types

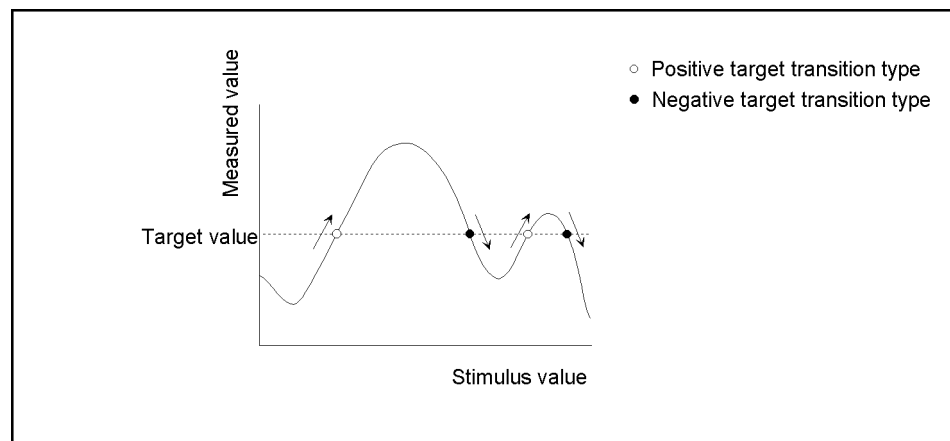

e5070aue050

### About the target search function

The target search is a function that searches for a target that matches the pre-defined target value and transition type(s) (positive, negative, or both positive and negative) and then moves the marker to the target being searched.

The following three methods are available for executing the target search:

|                                    |  |
|------------------------------------|--|
| <b>Target search (Search Peak)</b> | The marker will move to the peak with maximum response value if the peak polarity is <b>Positive</b> or <b>Both</b> or to the peak with minimum response value if the peak polarity is <b>Negative</b> . |
| <b>Search Left (Search Left)</b>   | Execute the search from the current marker position to the smaller stimulus values, and move the marker to the first target encountered.   |
| <b>Search Right (Search Right)</b> | Execute the search from the current marker position to the larger stimulus values, and move the marker to the first target encountered.  |



Figure 6-10

Target Search (when transition type is set to “both positive and negative”)

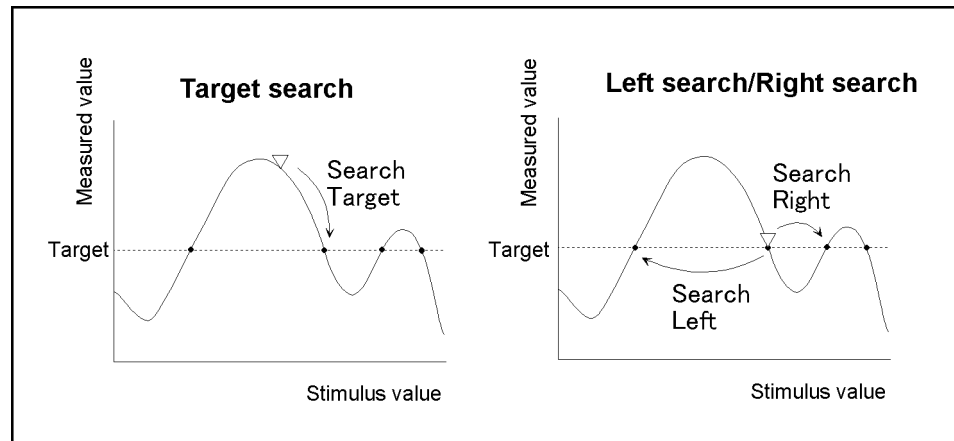

e5070aue048

### Executing a Target Search

**Step 1.** Following Step 1 to Step 4 in “Reading Values on the Trace” on page 125, activate the marker you are using for the target search.

**Step 2.** Press **Marker Search**.

**Step 3.** Press **Target**.

**Step 4.** Press **Target Value**, and enter the target value in the entry area that appears.

This causes the target search to be executed based on the definitions of the newly set the target value and currently set the transition type.

**Step 5.** Press **Target Transition**.

**Step 6.** Select a transition type.

| Softkey         | Function  |
|-----------------|---|
| <b>Positive</b> | Select Positive as the transition type.                   |
| <b>Negative</b> | Select Negative as the transition type.                   |
| <b>Both</b>     | Select both Positive and Negative as the transition type. |

This causes the target search to be executed based on the definitions of the currently set the target value and newly set the transition type.

**Step 7.** Press the corresponding softkey to move the marker to the target.

| Softkey              | Function                   |
|----------------------|----------------------------|
| <b>Search Target</b> | Execute the target search. |
| <b>Search Left</b>   | Execute the left search.   |
| <b>Search Right</b>  | Execute the right search.  |

### NOTE

When the data format is in Smith chart or polar format, execute the search for the main response value of the two marker response values.

## Searching for the Multiple Target Values (Multi-target Search)

The multi-target search function enables you to display a marker on each point having the target measurement value.

### Target and Transition Types

A target is a point that has a specific measurement value on the trace. Targets can be divided into the two groups shown below depending on their transition type.

**Transition type:**  
positive  
(Positive)                      When the value of the target is larger than the measurement value that immediately precedes (on the left side).

**Transition type:**  
negative  
(Negative)                      When the value of the target is smaller than the measurement value that immediately precedes (on the left side).

Figure 6-11

### Target and Transition Types

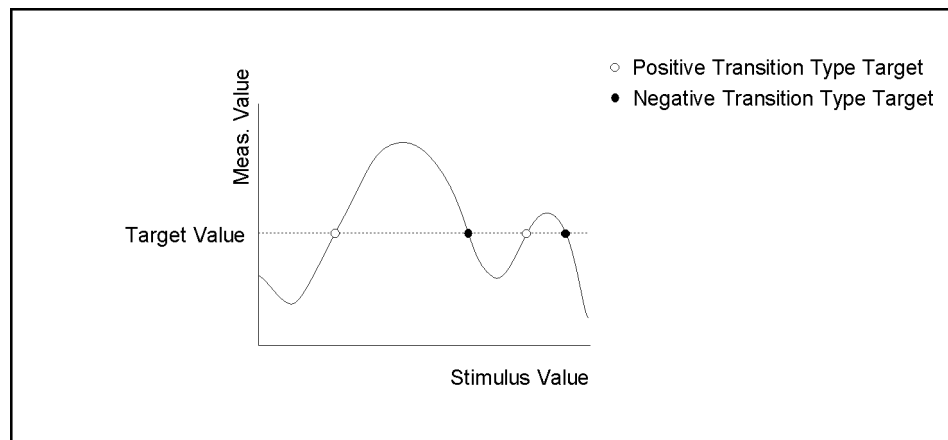

e5061aue023

### About the multi-target search function (Search Multi Target)

The multi-target search is a function that searches for targets that match to pre-defined target value and transition type(s) (positive, negative, or both of positive and negative) and display markers on the targets being searched.

Depending on number of detected targets, markers 1 through 9 are displayed from the start frequency.

### NOTE

When the multi-target search is executed, search and tracking settings for markers 1 through 9 are ignored and the settings for the multi-target search are used. Note that the reference marker is not affected.

Figure 6-12

Multi-target Search (when transition type is set to "both positive and negative")

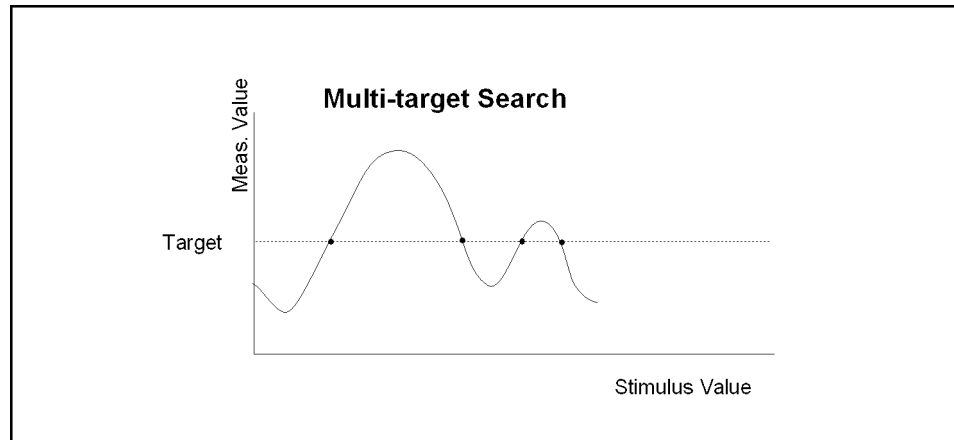

e5061aue024

**Executing a Multi-target Search**

**Step 1.** Following Step 1 through Step 4 in “Reading Values on the Trace” on page 125, activate a marker you are using for the target search.

**Step 2.** Press **Marker Search**.

**Step 3.** Press **Multi Target**.

**Step 4.** Press **Target Value**, and enter a target value in the entry box that appears.

This causes the target search to be executed based on the target value newly set and the transition type defined at this point.

**Step 5.** Press **Target Transition**.

**Step 6.** Selects a transition type.

| Softkey         | Function   |
|-----------------|--|
| <b>Positive</b> | Selects positive as the transition type.                   |
| <b>Negative</b> | Selects negative as the transition type.                   |
| <b>Both</b>     | Selects both positive and negative as the transition type. |

This causes the target search to be executed based on the target value set at this point and the transition type newly set.

**Step 7.** Press **Search Multi Target** to move the marker to the target.

**NOTE**

When the data format is in Smith chart or polar format, execute the search for the main response value of the two marker response values.

## Searching for the Peak

The peak search function enables you to move the marker to the peak on the trace.

### Definition of the Peak

A peak is a measurement point whose value is greater or smaller than the adjoining measurement points on its right and left sides. Peaks are classified into the following two types depending on the difference in magnitude from the measurement points on either side of it.

|                                     |   |
|-------------------------------------|---|
| <b>Positive peak<br/>(Positive)</b> | A peak whose measured value is greater than those of the measurement points on either side of it (peak polarity: positive). |
| <b>Negative peak<br/>(Negative)</b> | A peak whose measured value is smaller than those of the measuring points on either side of it (peak polarity: negative).   |

### About the Peak Search Function

The peak search is a function that searches for a peak that matches a pre-defined lower limit for the peak excursion value and peak polarity (positive or negative) and then moves the marker to the peak being searched.

The peak excursion value is the smaller of the differences in measured values from the adjoining peaks of the opposite polarity.

Figure 6-13

### Positive Peak/Negative Peak and Peak Excursion Value

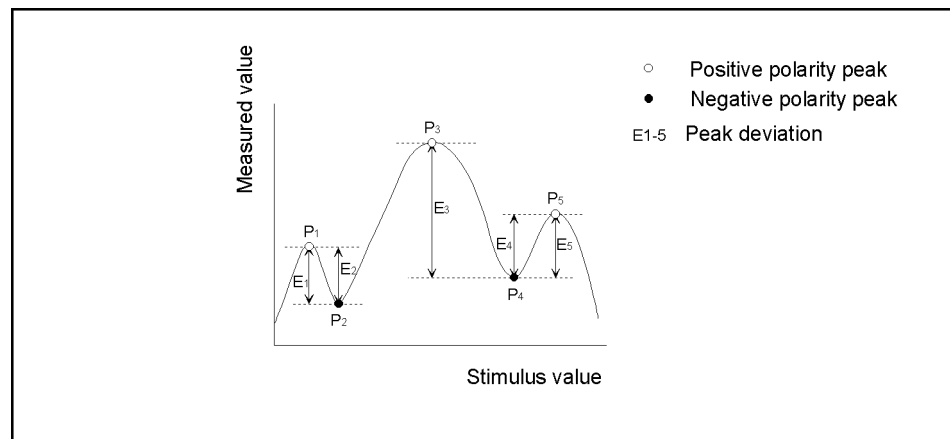

e5070aue051

The following three methods are available for executing the peak search:

|  |  |
|--|--|
| <b>Peak search<br/>(Search Peak)</b>   | Move the marker to the maximum peak when for the peak polarity is <b>Positive</b> or <b>Both</b> . Move the marker to the minimum peak when for the peak polarity is <b>Negative</b> . |
| <b>Left search<br/>(Search Left)</b>   | Execute the search from the current marker position to the smaller stimulus values, and move the marker to the first peak encountered.   |
| <b>Right search<br/>(Search Right)</b> | Execute the search from the current marker position to the larger stimulus values, and move the marker to the first peak encountered.  |

Figure 6-14

Peak Search (when peak polarity is positive)

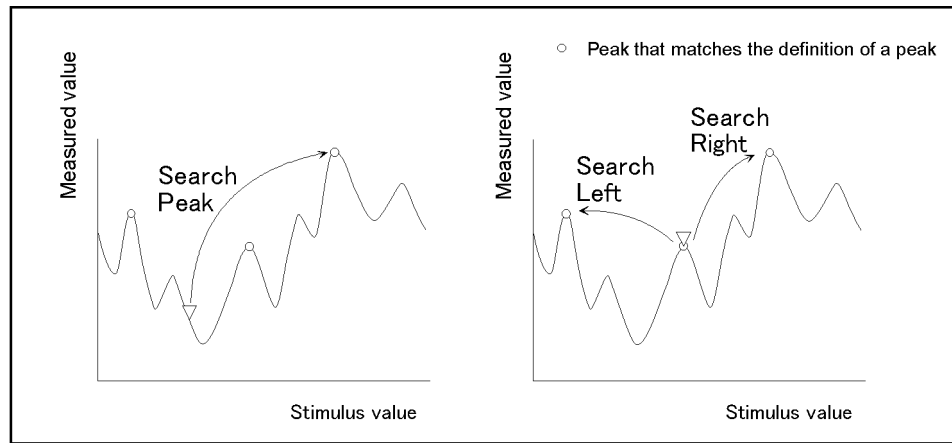

e5070bue071

**Executing a Peak Search**

**Step 1.** Following Step 1 to Step 4 in “Reading Values on the Trace” on page 125, activate the marker you are using for the peak search.

**Step 2.** Press **Marker Search**.

**Step 3.** Press **Peak**.

**Step 4.** Press **Peak Excursion**, and enter the lower limit for the peak excursion value.

This causes the peak search to be executed based on the definitions of the newly set the lower limit for the peak excursion value and currently set the peak polarity.

**Step 5.** Press **Peak Polarity**.

**Step 6.** Select a peak polarity.

| Softkey         | Function  |
|-----------------|---|
| <b>Positive</b> | Select Positive as the peak polarity.                   |
| <b>Negative</b> | Select Negative as the peak polarity.                   |
| <b>Both</b>     | Select both Positive and Negative as the peak polarity. |

This causes the peak search to be executed based on the definitions of the currently set the lower limit for the peak excursion value and newly set the peak polarity.

**Step 7.** Press the corresponding softkey to move the marker to the peak.

| Softkey             | Function                  |
|---------------------|---------------------------|
| <b>Search Peak</b>  | Execute the peak search.  |
| <b>Search Left</b>  | Execute the left search.  |
| <b>Search Right</b> | Execute the right search. |

**NOTE**

When the data format is in Smith chart or polar format, execute the search for the main response value of the two marker response values.

## Searching for Multiple Peaks

The multi-peak search function enables you to display markers on multiple peaks on traces.

### Definition of the Peaks

A peak is a measurement point whose value is greater or smaller than the adjoining measurement points on its right and left sides. Peaks are classified into the following types depending on the difference in magnitude from the measurement points on either side of it.

|                                 |   |
|---------------------------------|---|
| <b>Positive peak (Positive)</b> | A peak whose measurement value is greater than those of the measurement points on either side of it (peak polarity: positive)   |
| <b>Negative peak (Negative)</b> | A peak whose measurement value is smaller value than those of measurement points on either side of it (peak polarity: negative) |

### About the Multi-peak Search Function (Search Multi Peak)

The multi-peak search is a function that searches for peaks that match with pre-defined lower limit for the peak excursion value and peak polarity (positive or negative) and then displays the markers on the peaks being searched.

Depending on number of detected peaks, markers 1 through 9 are displayed from the start frequency.

The peak excursion is the smaller of the differences in measurement values from the adjoining peaks of the opposite polarity.

---

#### NOTE

When the multi-peak search is executed, search and tracking settings for markers 1 through 9 are ignored and the settings for the multi-peak search are used. Note that the reference marker is not affected.

---

Figure 6-15

Positive Peak/Negative Peak and Peak Excursion

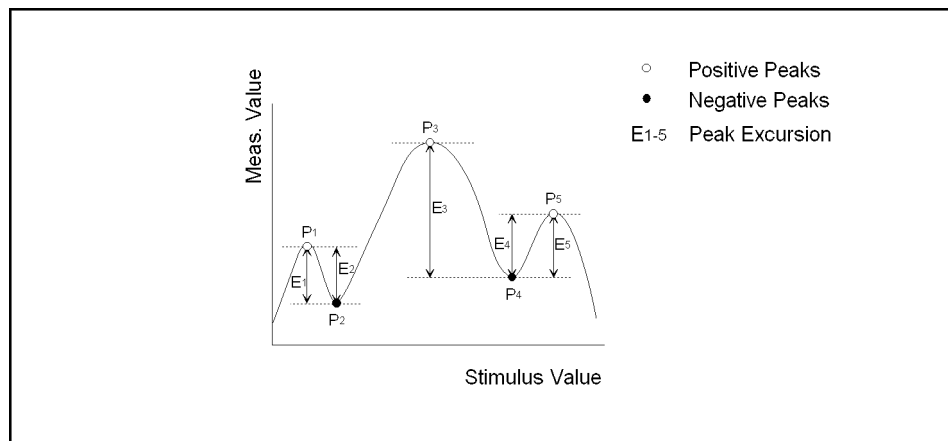

e5070aue051

**Figure 6-16 Multi-peak Search (when peak polarity is positive)**

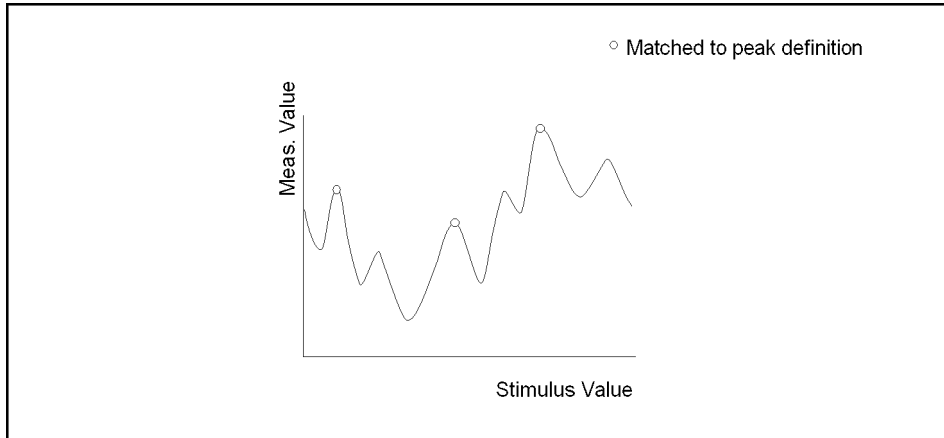

e5061aue025

**Executing a Multi-peak Search**

**Step 1.** Following Step 1 through Step 4 of “Reading Values on the Trace” on page 125, activate the marker you are using for the multi-peak search.

**Step 2.** Press **Marker Search**.

**Step 3.** Press **Multi Peak**.

**Step 4.** Press **Peak Excursion** and enter the lower limit for the peak excursion value.

This causes the multi-peak search to be executed based on the definitions of the newly set the lower limit for the peak excursion value and currently set the peak polarity.

**Step 5.** Press **Peak Polarity**.

**Step 6.** Select a peak polarity.

| Softkey         | Function  |
|-----------------|---|
| <b>Positive</b> | Select Positive as the peak polarity.                   |
| <b>Negative</b> | Select Negative as the peak polarity.                   |
| <b>Both</b>     | Select both Positive and Negative as the peak polarity. |

This causes the multi-peak search to be executed based on the definitions of the currently set the lower limit for the peak excursion value and newly set the peak polarity.

**Step 7.** Press **Search Multippeak** to move the marker to the peak.

**NOTE**

When the data format is Smith chart or polar format, execute the search for the main response value of the two marker response values.

## Determining the Bandwidth of the Trace (Bandwidth Search)

The bandwidth search is a function for determining the bandwidth of the trace, center frequency, cut-off points (on the higher frequency and the lower frequency sides), Q, and insertion loss, based on the position of the active marker. The definitions of the parameters determined through the bandwidth search are shown in Figure 6-8 and Table 6-2. The user specifies the defined bandwidth value in Figure 6-17.

Figure 6-17

### Bandwidth Parameters

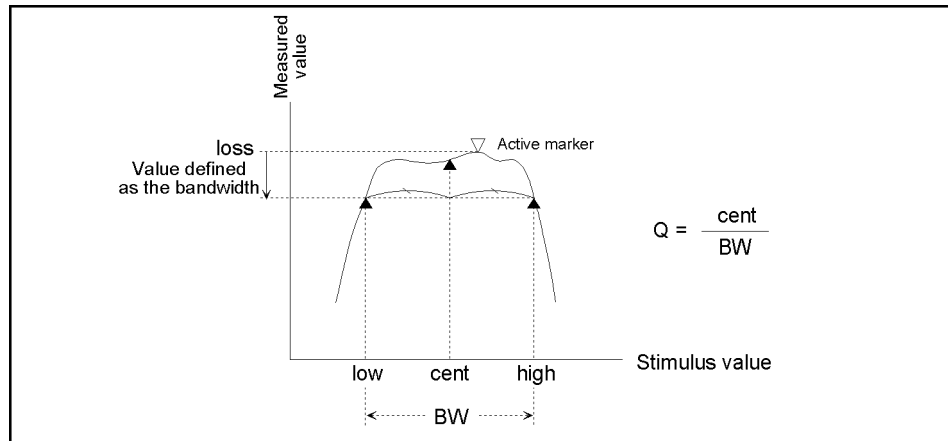

e5070aue054

Table 6-2

### Definitions of Bandwidth Parameters

| Bandwidth Parameter                            | Definition   |
|--|--|
| Insertion loss ( <b>loss</b> )                 | The measured value of the position of the active marker at the time the bandwidth search is executed.  |
| Lower frequency cut-off point ( <b>low</b> )   | Frequency at one of two measurement points, both separated by the defined bandwidth value from the active marker position, which corresponds to the lower of the two frequencies.  |
| Higher frequency cut-off point ( <b>high</b> ) | Frequency at one of two measurement points, both separated by the defined bandwidth value from the active marker position, which corresponds to the higher of the two frequencies. |
| Center frequency ( <b>cent</b> )               | Frequency at the midpoint between the lower frequency cut-off and higher frequency cut-off points ( $\frac{\text{high} + \text{low}}{2}$ ).  |
| Bandwidth ( <b>BW</b> )                        | The difference in frequency between the higher frequency cut-off and lower frequency cut-off points ( $\text{high} - \text{low}$ ).  |
| <b>Q</b>                                       | Value obtained by dividing the center frequency by the bandwidth ( $\frac{\text{cent}}{BW}$ ).   |



### Executing a Bandwidth Search

- Step 1.** Place the active marker on the desired point on the trace on which the bandwidth search is executed. The response value of this active marker itself is the insertion loss in the bandwidth search (**loss**).
- Step 2.** Press **Marker Search**.
- Step 3.** Press **Bandwidth Value** and enter the defined bandwidth value in the entry area that appears.
- Step 4.** Press **Bandwidth** to turn on the bandwidth search. In the upper left of the trace display, six bandwidth parameters are displayed. (See Figure 6-18.)

Figure 6-18

#### Bandwidth Search Results (defined bandwidth = -3 dB)

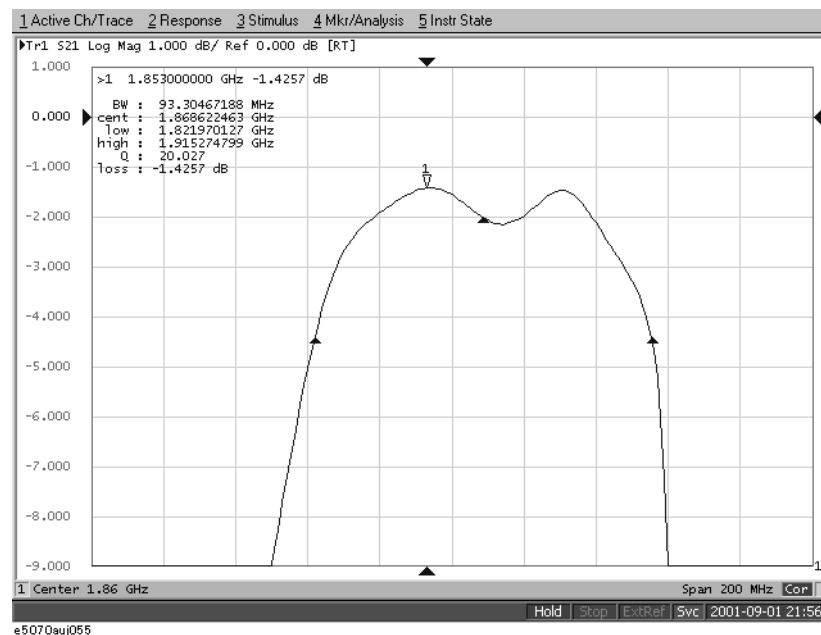

## Obtaining the bandwidth of a trace (notch search)

The notch search function is used to obtain the bandwidth, center frequency, cutoff points (high-frequency side and low-frequency side), Q, and insertion loss of a trace based on the active marker position. The notch search function starts from the left side of the active marker position, and ends when points that meet the conditions are found.

Figure 6-19 and Table 6-3 show the definition of parameters obtained by the notch search function. The notch value in Figure 6-19 must be specified by the user.

Figure 6-19

### Bandwidth parameters

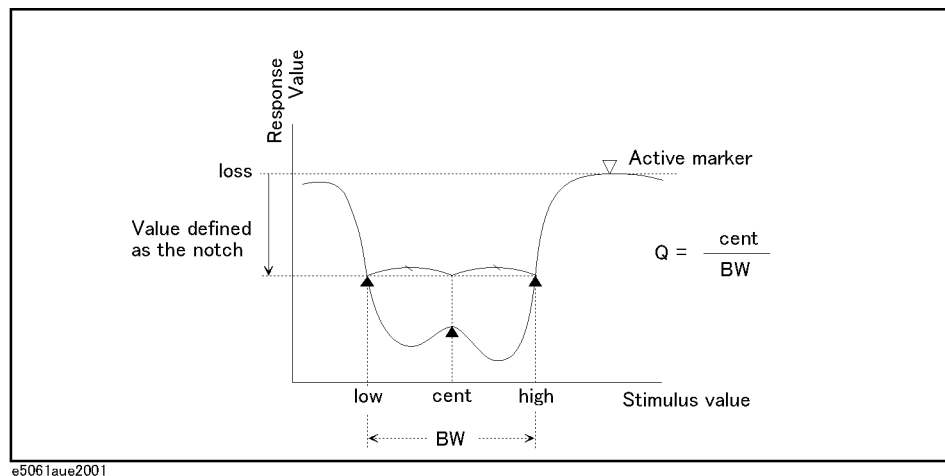

Table 6-3

### Definition of bandwidth parameters

| Bandwidth parameter name            | Definition   |
|-------------------------------------|--|
| Insertion loss ( <b>loss</b> )      | Measurement value at the active marker position when the notch search is executed.   |
| Lower cutoff point ( <b>low</b> )   | Lower frequency of the 2 points on both sides that have the measurement value apart from the active marker position by the notch value.  |
| Higher cutoff point ( <b>high</b> ) | Higher frequency of the 2 points on both sides that have the measurement value apart from the active marker position by the notch value. |
| Center frequency ( <b>cent</b> )    | Frequency of the middle point between the lower cutoff point and the higher cutoff point ( $\frac{high + low}{2}$ ).                     |
| Bandwidth ( <b>BW</b> )             | Frequency difference between the higher cutoff point and the lower cutoff point ( $high - low$ ).  |
| <b>Q</b>                            | Value obtained by dividing the center frequency by the bandwidth ( $\frac{cent}{BW}$ ).  |

## Executing a notch Search

- Step 1.** Place the active marker on the desired point on the trace on which the notch search is executed. The response value of this active marker itself is the insertion loss in the notch search (**loss**).
- Step 2.** Press **Marker Search**.
- Step 3.** Press **Notch Value** and enter the notch value in the entry area that appears.
- Step 4.** Press **Notch** to turn on the notch search. In the upper left of the trace display, six bandwidth parameters are displayed. (See Figure 6-20).

Figure 6-20

### Notch Search Results (notch value = -3 dB)

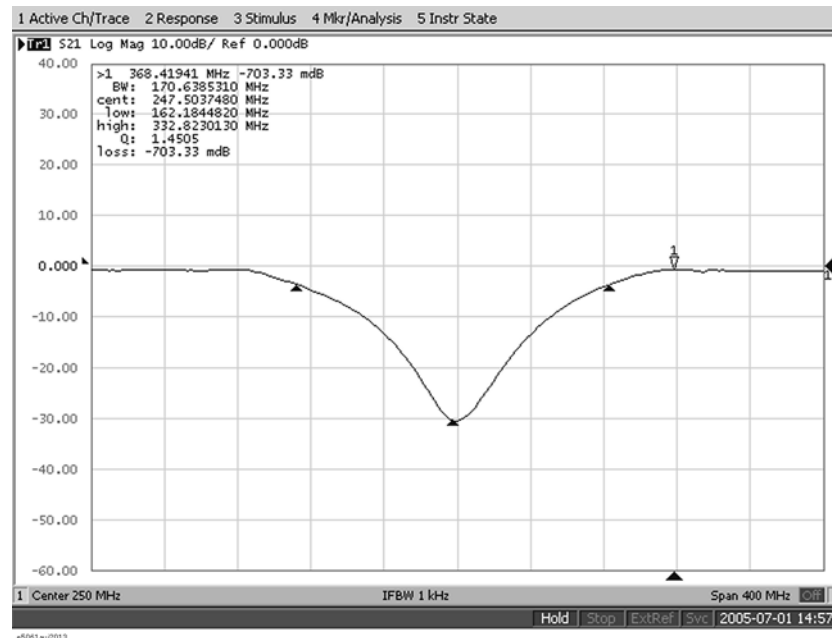

## Determining the Mean, Standard Deviation, and p-p of the Trace

You can easily determine the statistics data for a trace between the marker 1 and marker 2 (mean, standard deviation, and peak-to-peak). Figure 6-21 and Table 6-4 show the definitions for the statistics data elements.

**Figure 6-21**

**Parameters Used for Calculating Statistics Data**

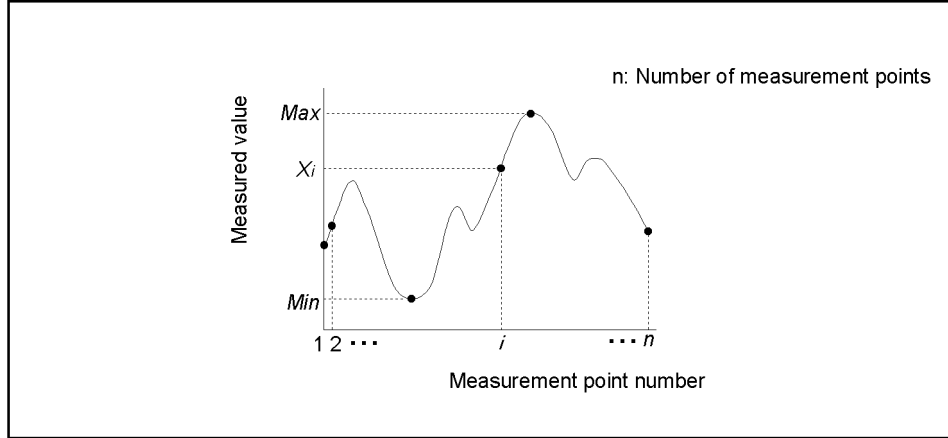

**Table 6-4**

**Definitions of Statistics Data**

| Statistics data element              | Definition  |
|--------------------------------------|---|
| Mean ( <b>mean</b> )                 | $\frac{\sum_{i=1}^n x_i}{n}$ (n: number of points; xi: i measured value at the ith measurement point)   |
| Standard deviation ( <b>s. dev</b> ) | $\sqrt{\frac{\sum_{i=1}^n (x_i - \text{mean})^2}{n - 1}}$ (n: number of points; xi: F i measured value at the ith measurement point mean: Mean) |
| Peak-to-peak ( <b>p - p</b> )        | $\text{Max} - \text{Min}$ (Max: greatest measured value; Min: smallest measured value)  |

### Displaying Statistics Data

**Step 1.** Press **Channel Next** (or **Channel Prev**) and **Trace Next** (or **Trace Prev**) to activate the trace for which statistics data is required.

**Step 2.** Press **Marker Fctn**.

**Step 3.** Press **Statistics** to turn on the display of statistics data.

## Obtaining Span, Gain, Slope, and Flatness between Markers

The span, gain, slope, and flatness between marker 1 and marker 2 on a trace can be obtained. Figure 6-22 and Table 6-5 shows data definitions.

Figure 6-22 Parameters to Calculate Data

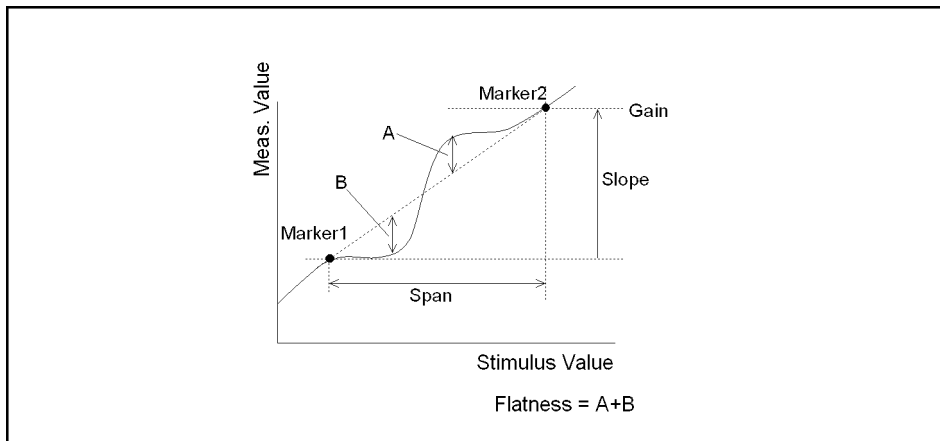

e5061aue026

Table 6-5 Data Definition

| Data name              | Definition   |
|------------------------|--|
| Span<br>(span)         | Calculates the distance between marker 1 and marker 2.   |
| Gain<br>(gain)         | Calculates the larger measurement value of marker 1 and marker 2.  |
| Slope (slope)          | Calculates the difference in measurement value between marker 1 and marker 2. (marker 2 - marker 1)                                      |
| Flatness<br>(flatness) | Calculates the sum of 2 maximum measurement value differences from the line connecting marker 1 and marker 2 (above and below the line). |

### Operational procedure

- Step 1. Press **Channel Next** (or **Channel Prev**) and **Trace Next** (or **Trace Prev**) to activate a trace for which you want to obtain statistical data.
- Step 2. Press **Marker Fctn**.
- Step 3. Press **Flatness** to show data.
- Step 4. Set the positions of marker 1 and marker 2 on the trace.

**NOTE** Turning on the marker flatness display turns on the display of marker 1 and marker 2.

## Obtaining Loss, Ripple, and Attenuation of the RF Filter

Specify the pass band with markers 1 and 2 on the trace and specify the stop band with markers 3 and 4 to obtain loss, ripple, and attenuation. Figure 6-23 and Table 6-5 shows data definitions.

**Figure 6-23**

**Parameters to Calculate Data**

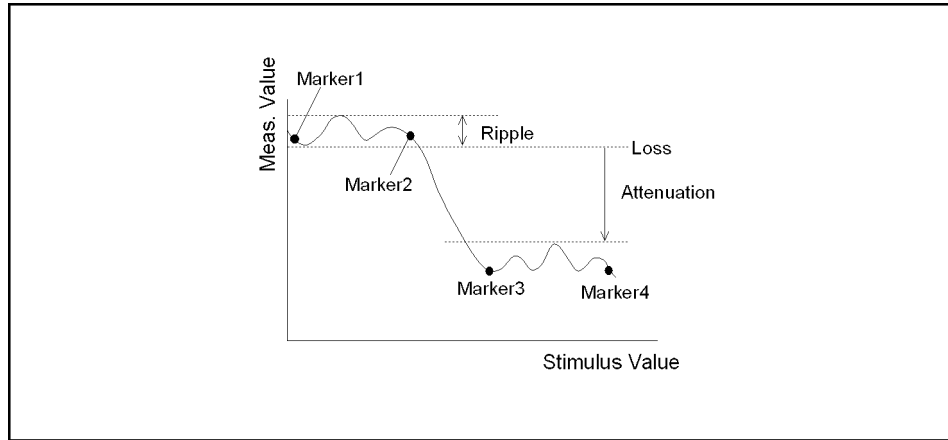

e5061aue027

**Table 6-6**

**Data Definitions**

| Data name                        | Definition  |
|----------------------------------|---|
| Loss<br>( <b>loss</b> )          | Calculates the minimum value between markers 1 and 2.   |
| Ripple ( <b>p-p</b> )            | Calculates the difference between the maximum value and the minimum value for the difference between markers 1 and 2.             |
| Attenuation<br>( <b>reject</b> ) | Calculates the difference between the maximum value between markers 3 and 4 and the minimum value (loss) between markers 1 and 2. |

### Operational procedure

- Step 1.** Press **Channel Next** (or **Channel Prev**) and **Trace Next** (or **Trace Prev**) to activate a trace for which you want to obtain statistical data.
- Step 2.** Press **Marker Fctn**.
- Step 3.** Press **RF Filter Stats** to show data.
- Step 4.** Set the positions of marker 1 through marker 4 on the trace.

**NOTE**

Turning on the RF filter status display turns on the display of marker 1 through 4.

## Comparing Traces/Performing Data Math

Each of the traces for which measured data is displayed is provided with an additional trace, called a memory trace, that temporarily stores measured data. You can use the memory trace to compare traces on the screen or to perform complex data math between it and measured data.

The following data math operations are available:

|                      |   |
|----------------------|---|
| <b>Data / Memory</b> | Divides the measured data by the data in the memory trace. This function can be used to evaluate the ratio of two traces (e.g., evaluating gain or attenuation).  |
| <b>Data * Memory</b> | Multiplies the measured data by a memory trace.   |
| <b>Data – Memory</b> | Subtracts a memory trace from the measured data. This function can be used, for example, to subtract a vector error that has been measured and stored (e.g., directivity) from later data measured on a device. |
| <b>Data + Memory</b> | Adds the measured data and the data in the memory trace.  |

### Performing Data Math Operations

- Step 1.** Press **Channel Next** (or **Channel Prev**) and **Trace Next** (or **Trace Prev**) to activate the trace to be stored in memory.
- Step 2.** Press **Display**.
- Step 3.** Press **Data** → **Mem** to store the measured data in memory.
- Step 4.** Press **Data Math**.
- Step 5.** Select the data math operation to perform.

| Softkey           | Function  |
|-------------------|---|
| <b>OFF</b>        | Turns off data math functions (Do not perform data math.).                            |
| <b>Data / Mem</b> | Divide the measured data by the memory trace and store the result in the data trace.  |
| <b>Data * Mem</b> | Multiply the data trace by the memory trace and store the result in the data trace.   |
| <b>Data – Mem</b> | Subtract the memory trace from the data trace and store the result in the data trace. |
| <b>Data + Mem</b> | Add the data trace and memory trace and store the result in the data trace.           |

- Step 6.** Press **Display**.

Data Analysis  
**Comparing Traces/Performing Data Math**

**Step 7.** Select the type of data to display on the screen.

| <b>Softkey</b>        | <b>Function</b>  |
|-----------------------|--|
| <b>Data</b>           | Display only the data trace on the screen.   |
| <b>Mem</b>            | Display only the memory trace stored by the operation <b>Data</b> → <b>Mem</b> on the screen.                                    |
| <b>Data &amp; Mem</b> | Display the data trace and memory trace on the screen. You can now easily compare the data trace and memory trace on the screen. |
| <b>Off</b>            | Do not display the trace.  |

**Step 8.** Apply the trigger to make measurements.



## Performing parameter conversion of measurement result

You can use the parameter conversion function to convert the measurement result of the S-parameter ( $S_{ab}$ ) to the following parameters.

- ❑ Equivalent impedance ( $Z_r$ ) and equivalent admittance ( $Y_r$ ) in reflection measurement

$$Z_r = Z_{0a} \times \frac{1 + S_{ab}}{1 - S_{ab}}, Y_r = \frac{1}{Z_r}$$

- ❑ Equivalent impedance ( $Z_t$ ) and equivalent admittance ( $Y_t$ ) in transmission measurement

$$Z_t = \frac{2 \times \sqrt{Z_{0a} \times Z_{0b}}}{S_{ab}} - (Z_{0a} + Z_{0b}), Y_t = \frac{1}{Z_t}$$

- ❑ Inverse S-parameter ( $\frac{1}{S_{ab}}$ )

Where,

$Z_{0a}$                       Characteristic impedance of port a\*1

$Z_{0b}$                       Characteristic impedance of port b\*1

### Operational procedure

#### ON/OFF

**Step 1.** Press **Channel Next** or **Channel Prev** to activate a channel on which you want to use the marker.

**Step 2.** Press **Trace Next** or **Trace Prev** to activate a trace on which you want to use the marker.

**Step 3.** Press **Analysis**.

**Step 4.** Press **Conversion**.

**Step 5.** Press **Conversion** to turn ON the conversion function.

\*1. The system Z0 (preset value: 50Ω) is used.

**Selecting conversion target parameter**

- Step 1.** Press **Channel Next** or **Channel Prev** to activate a channel on which you want to use the marker.
- Step 2.** Press **Trace Next** or **Trace Prev** to activate a trace on which you want to use the marker.
- Step 3.** Press **Analysis**.
- Step 4.** Press **Conversion**.
- Step 5.** Press **Function**.
- Step 6.** Press the softkey corresponding to the parameter to which you want to convert.

When the conversion function is ON, the selected parameter is displayed in the “5-5. Trace Status Area” on page 38.

---

**7****Data Output**

This chapter explains the concepts behind saving/recalling internal data and printing the information that is displayed on the screen. Procedures for performing these tasks with the Agilent E5061A/E5062A are also given.

## Saving and Recalling Instrument State

You can save the instrument state of the E5061A/E5062A into a file on the mass storage (hard disk drive or floppy disk drive) and then recall it later to reproduce that state. You can select the stored data from the following 4 types.

**Table 7-1**

**Stored data**

| Type   | Stored data and usage   |
|--|---|
| State only<br>(State Only)                   | Saves the setting <sup>*1</sup> of the E5061A/E5062A and reproduces the state when it was saved by recalling it later into the E5061A/E5062A.   |
| State and calibration data<br>(State & Cal)  | Saves the setting <sup>*1</sup> of the E5061A/E5062A and calibration data (calibration coefficient array <sup>*2</sup> ) to reproduce the state when it was saved by recalling it later into the E5061A/E5062A. At this time, you can perform error correction of measured values using the recalled calibration data.    |
| State and trace<br>(State & Trace)           | Saves the setting <sup>*1</sup> of the E5061A/E5062A and traces (error corrected data array <sup>*2</sup> and error corrected memory array <sup>*2</sup> ) to reproduce the state when it was saved by recalling it later into the E5061A/E5062A. At this time, the traces are also recalled and displayed on the screen. |
| State, calibration data, and traces<br>(All) | Saves the setting <sup>*1</sup> of the E5061A/E5062A, calibration data, and traces to reproduce the state when it was saved by recalling it later into the E5061A/E5062A. At this time, the calibration data and traces are also recalled.  |

\*1. For information on the saved target, refer to Appendix C, “List of Default Values.”

\*2. For information on each array, refer to “Data Processing” on page 362.

In addition, the “user-preset” function is provided to allow the user to freely set up an instrument state recalled when the preset function is executed. For more information on how to set it up, see “Setting the user preset function” on page 234.

### Compatibility of files related to saving and recalling

The compatibility of saving/recalling the instrument state file is as follows:

- o Compatibility between different models
  - Files saved with the E5062A cannot be recalled with the E5061A but the opposite is not possible.

|      |        | Recall |        |
|------|--------|--------|--------|
|      |        | E5061A | E5062A |
| Save | E5061A | Y      | Y      |
|      | E5062A | N      | Y      |

Y: Recall is possible

N: Recall is not possible

- o Compatibility between models that have different options (test set types: transmission\reflection or S-parameter, 50 Ω or 75 Ω, and power range expansion)
  - Files are not compatible between 50 Ω and 75 Ω models.
  - Files saved with a model with a T/R test set can be recalled with a model with an S-parameter test set but the opposite is not possible.
  - Files saved with a model not having the power range expansion feature can be recalled with a model having the power range expansion feature but the opposite is not possible.

|      |         |      |     |         | Recall        |     |      |         |     |         |     |
|------|---------|------|-----|---------|---------------|-----|------|---------|-----|---------|-----|
|      |         |      |     |         | Without       |     | With |         |     |         |     |
|      |         |      |     |         | 50Ω           | 75Ω | 50Ω  |         | 75Ω |         |     |
|      |         |      |     |         | T/R           | T/R | T/R  | S-P     | T/R | S-P     |     |
|      |         |      |     |         | Option number | 150 | 175  | 150 1E1 | 250 | 175 1E1 | 275 |
| Save | Without | 50 Ω | T/R | 150     | Y             | N   | Y    | Y       | N   | N       |     |
|      |         | 75 Ω | T/R | 175     | N             | Y   | N    | N       | Y   | Y       |     |
|      | With    | 50 Ω | T/R | 150 1E1 | N             | N   | Y    | Y       | N   | N       |     |
|      |         |      | S-P | 250     | N             | N   | N    | Y       | N   | N       |     |
|      |         | 75 Ω | T/R | 175 1E1 | N             | N   | N    | N       | Y   | Y       |     |
|      |         |      | S-P | 275     | N             | N   | N    | N       | N   | Y       |     |

Y: Recall is possible

N: Recall is impossible

**NOTE** If you recall an incompatible file, an error occurs and the presetting is recovered.

## Save procedure

### Selecting content to be saved

---

**NOTE**

---

This setting takes the effect both when saving the entire instrument state into a file and when saving the instrument state for each channel into memory.

- Step 1.** Press **Save/Recall**.
- Step 2.** Press **Save Type**.
- Step 3.** Press the softkey corresponding to the content of the instrument state you want to save.

| Softkey                  | Function   |
|--------------------------|--|
| <b>State Only</b>        | Selects saving the state of the E5061A/E5062A only.                          |
| <b>State &amp; Cal</b>   | Selects saving the state and calibration data of the E5061A/E5062A.          |
| <b>State &amp; Trace</b> | Selects saving the state and traces of the E5061A/E5062A.                    |
| <b>All</b>               | Selects saving the state, calibration data, and traces of the E5061A/E5062A. |

### Selecting save target channel/trace

- Step 1.** Press **Save/Recall**.
- Step 2.** Press **Channel/Trace** and select the save target from all channels/traces (**All**) or displayed channel/traces only (**Disp Only**).

If you specify the displayed channel/traces only as the save target, you can reduce the file size. However, for channels/traces that are not displayed, you cannot recall and reproduce the instrument state separately held for each channel/trace at a later time.

### Saving Instrument State

Follow the procedure below to save internal data from the E5061A/E5062A.

**Step 1.** Press **Save/Recall**.

**Step 2.** Press **Save State**.

**Step 3. When you want to use a pre-defined file name (State01.sta - State08.sta, Autorec.sta)**

Press **State01 - State08** or **Autorec**.

#### NOTE

If “A:\Autorec.sta” or “D:\Autorec.sta” is found on the system at startup, the E5061A/E5062A is automatically configured using the saved settings. When both files are found, “A:\Autorec.sta” is recalled. To disable the auto recall function, delete the Autorec.sta files.

#### NOTE

An asterisk (\*) in the upper right of the softkey indicates that, the corresponding file of the softkey already exist. If you save into the existing file, the existing file is copied as “backup.sta” and then it is overwritten.

### When you want to use other file name or a file name on the floppy disk

1. Press **File Dialog...** to open the Save As dialog box. Figure 7-1 explains the Save As dialog box.
2. Select the folder and input a file name using the external keyboard and mouse.
3. Click **Save**

Figure 7-1

Save As Dialog Box

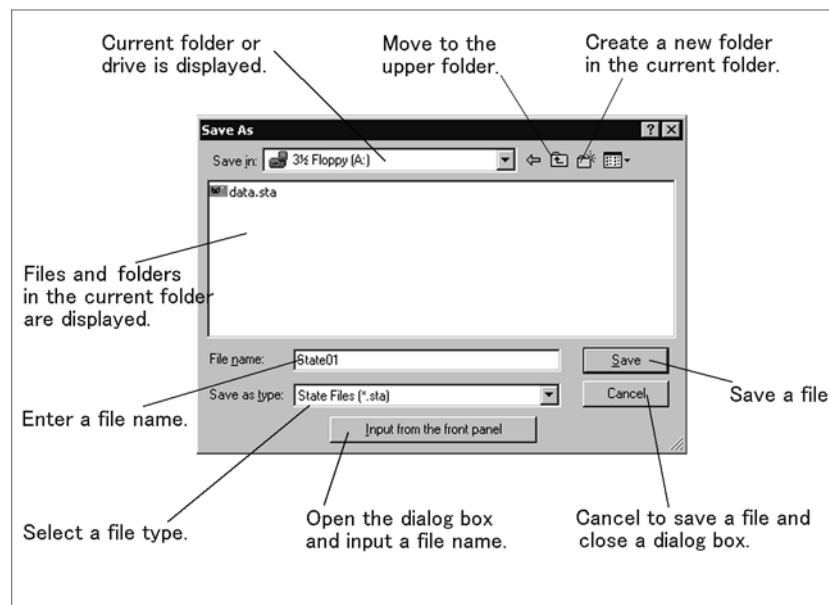

## Data Output

### Saving and Recalling Instrument State

On the E5061A/E5062A, the following drives are available for saving/recalling files. Select the appropriate drive from the **Save In** pull-down menu shown in Figure 7-1

| Drive             | Description  |
|-------------------|--|
| 3 1/2 Floppy [A:] | Select this drive when saving or recalling a file to/from a floppy disk *1.              |
| [D:]              | Select this drive when saving or recalling a file to/from the hard disk drive (D drive). |

\*1. When using the built-in floppy disk drive on the E5061A/E5062A, insert a 1.44 MB floppy disk formatted in DOS format.

---

#### NOTE

Do not modify any files and folders in drives other than drive A: and drive D:. Doing so will cause malfunctions.

---

#### NOTE

**Do not press the disk eject button while the floppy disk access lamp is on.** Trying to forcefully pull the floppy disk out while the lamp is on may damage the floppy disk or disk drive.

---

### Typing in a file name from the front panel

You can enter a file name using the **Input from the front panel** buttons on the dialog box when storing a file.

Figure 7-2

#### Input from Front Panel

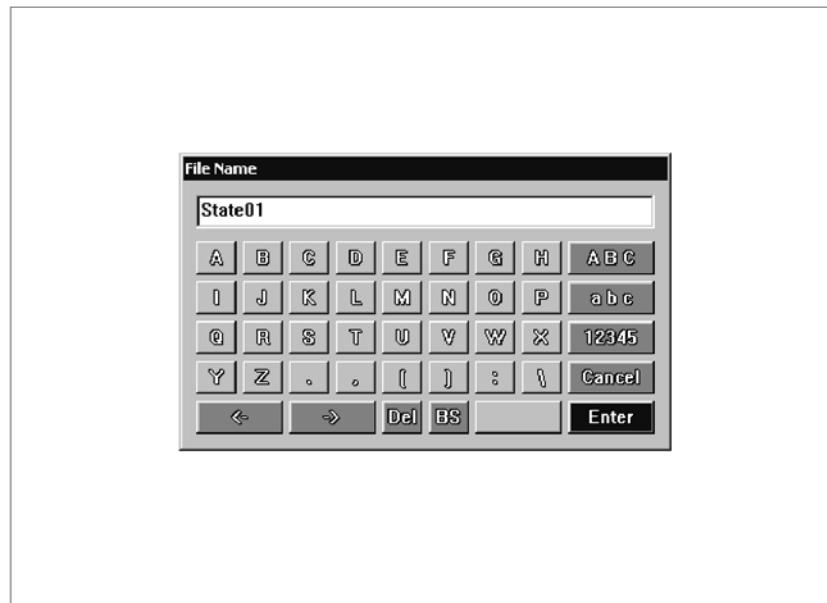



## Recall procedure

Follow the procedure below to recall internal data from the E5061A/E5062A.

### NOTE

If you recall the file that includes traces (its content was set to **State &Trace** or **All** when it was saved), the trigger source is automatically set to Manual.

**Step 1.** Press **Save/Recall**.

**Step 2.** Press **Recall State**.

**Step 3. When you want to recall State01.sta - State08.sta, Autorec.sta**

Press **State01 - State08** or **Autorec**.

### When you want to recall other files

1. Press **File Dialog...** to open the Open dialog box. Figure 7-3 describes the Open dialog box
2. Select the folder and the file using the external keyboard and mouse.
3. Click **Open**.

Figure 7-3

Open Dialog Box

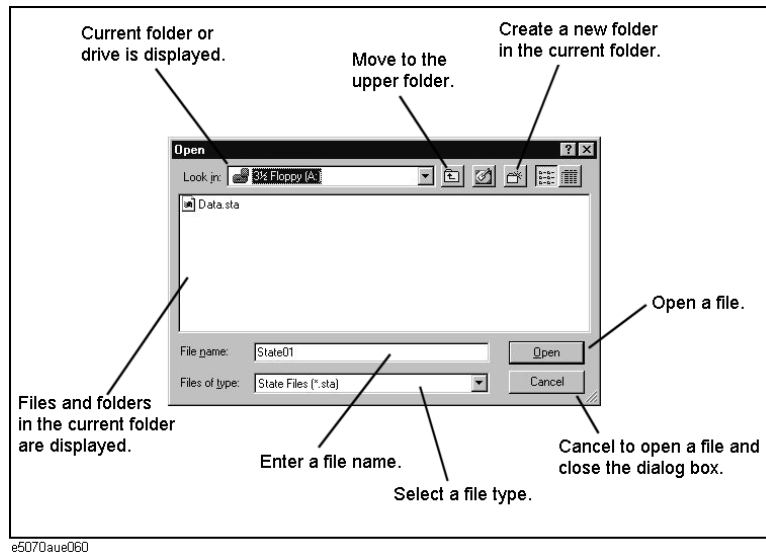

### NOTE

**Do not press the disk eject button while the floppy disk access lamp is on.** Trying to forcefully pull the floppy disk out while the lamp is on may damage the floppy disk or disk drive.

## Recall Procedure Using “Recall by File Name” Feature

You can use the recall feature with the **Recall by File Name** softkey for files you have named freely and saved in the **D:\State** folder. This function lets you recall a file you have named freely and saved by simple softkey operation, eliminating annoying operation using the

## Data Output

### Saving and Recalling Instrument State

Open dialog box.

---

#### NOTE

Although there is no limit to the number of files saved in a folder, only up to 50 files are displayed on the softkeys. If more than 50 files are saved in a folder, they are sorted in the order of numbers 0 to 9 and alphabetic characters A to Z and the first 50 files are displayed as softkeys.

Although there is no limit to the number of characters of a file name, only up to 12 characters are displayed on the softkey. If a file name exceeds 12 characters, the first 12 characters are displayed on the softkey and the remaining characters are omitted and replaced with "...".

Note that different files may be displayed on softkeys with the same name or a saved file is not displayed on any softkey because of the above limitations.

---

**Step 1.** Press Save/Recall.

**Step 2.** Press **Recall by File Name**.

**Step 3.** Files that have been named and saved in the D:\State folder are displayed on softkeys. Press the key for the file you want to recall.

#### Order of recalling the configuration file at startup

If several instrument configuration files exist at the startup of the E5061A/E5062A, only one file is recalled at a time, and this is done in the following order.

If these files do not exist, the normal preset (factory preset) is executed.

| Recall order | Recalled file   |
|--------------|---|
| 1            | Configuration file for the auto-recall function in the A drive    |
| 2            | Configuration file for the auto-recall function in the D drive    |
| 3            | Configuration file for the user-preset function in the D drive *1 |

\*1. Executed when the preset operation mode is User and the file (D:\UserPreset.sta) exists.

## Saving/recalling instrument state for each channel into/from memory

The E5061A/E5062A allows you to save/recall the instrument state for each channel only. This function lets you save the instrument state of the active channel only that is specified independently for each channel into one of registers A to D (volatile memory) and recall the instrument state saved in one of registers A to D to restore it as the state of the active channel. Like when saving the entire state of the instrument into a file, you can select items to be saved from 4 kinds (refer to Table 7-1).

Because you can call the instrument state for each channel saved with this function from a channel different from the channel used when it was saved, you can use this function to copy an instrument state between channels.

### NOTE

Unlike when saving the entire instrument state, the instrument state for each channel is saved into volatile memory instead of a file and therefore, if you turn off the power, it is lost.

## Operational procedure

### Saving instrument state for each channel

- Step 1.** Press **Channel Next** or **Channel Prev** to activate a channel whose state you want to save.
- Step 2.** Press **Save/Recall**.
- Step 3.** Press **Save Channel**.
- Step 4.** Press one of **State A** to **State D** to save the instrument state of the active channel to the specified register.

### NOTE

For registers having saved data, the \* symbol is displayed to the right of their softkey label. If you specify one of them, it is overwritten.

### Recalling instrument state for each channel

- Step 1.** Press **Channel Next** or **Channel Prev** to activate a channel whose state you want to recall and restore.
- Step 2.** Press **Save/Recall**.
- Step 3.** Press **Recall Channel**.
- Step 4.** Press the softkey of the register in which the state you want to restore is saved. The instrument state for the channel is recalled to the active channel.

### Deleting the saved instrument states (clearing all the registers)

- Step 1.** Press **Save/Recall**.
- Step 2.** Press **Save Channel**.
- Step 3.** Press **Clear States**. The contents of all the registers are deleted.

---

## Saving/Recalling Calibration Data for Each Channel into/from Memory

The E5061A/E5062A allows you to save/recall the calibration data for each channel only. This feature lets you save the calibration data of the active channel only that is specified independently for each channel into one of registers A to D (volatile memory) and recall the calibration data saved in one of registers A to D to restore it as the calibration data of the active channel.

Because you can call the calibration data for each channel saved with this feature from a channel different from the channel used when it was saved, you can use this feature to copy a calibration data between channels.

---

**NOTE**

Because calibration data for each channel is saved in volatile memory instead of a file, it is lost when you turn off the power.

---

### Operational Procedure

#### Saving calibration data for each channel

- Step 1.** Press **Channel Next** or **Channel Prev** to activate a channel whose calibration data you want to save.
- Step 2.** Press **Save/Recall**.
- Step 3.** Press **Save Channel**.
- Step 4.** Press one of **Cal Only A** to **Cal Only D** to save the calibration data of the active channel to the specified register.

---

**NOTE**

For registers having saved data, the \* symbol is displayed to the right of their softkey label. If you specify one of them, it is overwritten.

---

#### Recalling calibration data for each channel

- Step 1.** Press **Channel Next** or **Channel Prev** to activate a channel whose calibration data you want to recall and restore.
- Step 2.** Press **Save/Recall**.
- Step 3.** Press **Recall Channel**.
- Step 4.** Press the softkey of the register in which the calibration data you want to restore is saved. The calibration data for the channel is recalled to the active channel.

#### Deleting saved calibration data (clearing all registers)

- Step 1.** Press **Save/Recall**.
- Step 2.** Press **Save Channel**.
- Step 3.** Press **Clear States**. The contents of all the registers are deleted.

## Saving Trace Data to a File

### Saving data as a CSV file

The E5061A/E5062A allows the user to save data for the active trace on the active channel as a CSV file (file extension \*.csv) and load the data into PC application software for further processing.

Trace data will be saved in the format shown below.

#### Example 7-1

#### Example of Saved Trace Data

```
"# Channel 1"
"# Trace 1"
Frequency,          Formatted Data,      Formatted Data
+3.000000000000E+005, +1.41837599227E-002, +1.43446459328E-006
+4.279850000000E+007, +1.41275293412E-002, +2.02407834551E-004
+8.529700000000E+007, +1.41334093048E-002, +4.00643331604E-004
+1.277955000000E+008, +1.41240661092E-002, +6.09250514670E-004
+1.702940000000E+008, +1.41402155348E-002, +8.05620003993E-004
```

The first line shows the number of the active channel at the time the data was saved.

The second line shows the number of the active trace at the time the data was saved.

The third line is a header line indicating the contents of each trace data written on the fourth line onward.

The fourth line onward show the trace data. The amount of data is determined by the number of points (frequency) assigned to the trace.

### Saving Trace Data

Follow the procedure below to save trace data from the E5061A/E5062A.

- Step 1.** Press  or  to select the channel that contains the trace to be saved.
- Step 2.** Press  or  to select the trace to be saved.
- Step 3.** Press  to open the Save/Recall menu.
- Step 4.** Press **Save Trace Data** to open the Save As dialog box. When the dialog box appears, use the external keyboard and mouse to complete the task. For more information on the Save As dialog box, see Figure 7-1, "Save As Dialog Box," on page 161. Note that "CSV Files (\*.csv)" will already be selected as the file type when the dialog box first opens.
- Step 5.** Select the destination folder and input a file name. Press **Save** to save the file.

#### NOTE

**Do not press the disk eject button while the floppy disk access lamp is on.** Trying to forcefully pull the floppy disk out while the lamp is on may damage the floppy disk or disk drive.

## Saving data in Touchstone format

Use the following VBA macro to save measurement data into a file in Touchstone format.

| Folder     | VBA macro name (project name) |
|------------|-------------------------------|
| D:\Agilent | SaveToTouchstone.vba          |

---

**NOTE** Don't delete this VBA macro. This VBA macro can not be restored by executing system recovery.

---

This VBA macro saves measurement data of any channel into a Touchstone format file, based on 1 or 2 port models.

---

**NOTE** You can save data in “real number - imaginary number”, “dB - angle” or “amplitude - angle.”

---

You can use data saved in Touchstone format for a circuit simulator such as Agilent Advanced Design System (ADS) on your PC (personal computer) or workstation. For more information on the ADS, refer to the operation manual that comes with the system.

---

**NOTE** You cannot recall data saved in Touchstone format on the E5061A/E5062A.

---

For information on data structure in a saved file, refer to “Data structure in Touchstone file” on page 170.

### Operating procedure

#### 1. Starting VBA macro

- Step 1.** Press **[Macro Setup]**.
- Step 2.** Press **Load Project**.
- Step 3.** The Open dialog box appears. Specify the file name “D:\Agilent\SaveToTouchstone.vba” and press the **Open** button.
- Step 4.** Press **[Macro Run]** to start the macro. (Refer to Figure 7-4.)

Figure 7-4 SaveToTouchstone

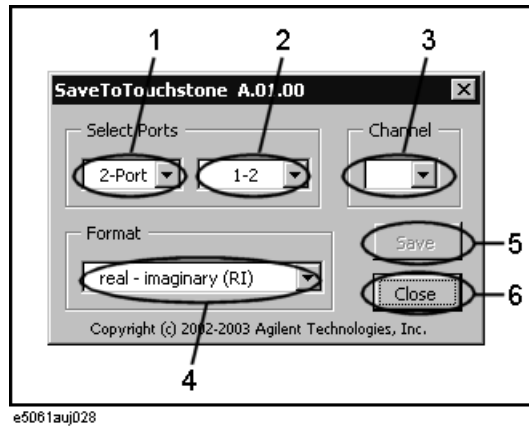

## 2. Saving data

**Step 1.** Select the number of ports (1 in Figure 7-4) and test ports (2 in Figure 7-4).

**Step 2.** Select a channel (3 in Figure 7-4).

**NOTE** The channel selected in this step has no relation to active channel.

**Step 3.** Select the data saving format (4 in Figure 7-4).

|                                |   |
|--------------------------------|---|
| <b>real - imaginary (RI)</b>   | real and imaginary parts                      |
| <b>magunitude - angle (MA)</b> | linear magnitude and phase (degree)           |
| <b>dB - angle (DB)</b>         | logarithmic magnitude (dB) and phase (degree) |

**Step 4.** Press the **Save** button (5 in Figure 7-4). Measurement of necessary data for the selected channel in Step 2 starts.

**NOTE** Regardless of state of the trigger system, measurement is automatically performed once.

**NOTE** Regardless of on/off state of the balance-unbalance conversion, measurement is performed without the balance-unbalance conversion.

**Step 5.** When the measurement is complete, the Save As dialog box appears. Specify a file name and press the **Save** button.

**Step 6.** When saving to the file is complete, the start screen appears again.

## 3. Closing VBA macro

**Step 1.** Press the **Close** button (6 in Figure 7-4) to exit from the macro.

## Data Output

### Saving Trace Data to a File

#### Data structure in Touchstone file

Figure 7-5 through Figure 9-6 show the data structure of a file saved in Touchstone format. Contents of the file is text data, which is ready for being read with your text editor.

**Figure 7-5** One port Touchstone file

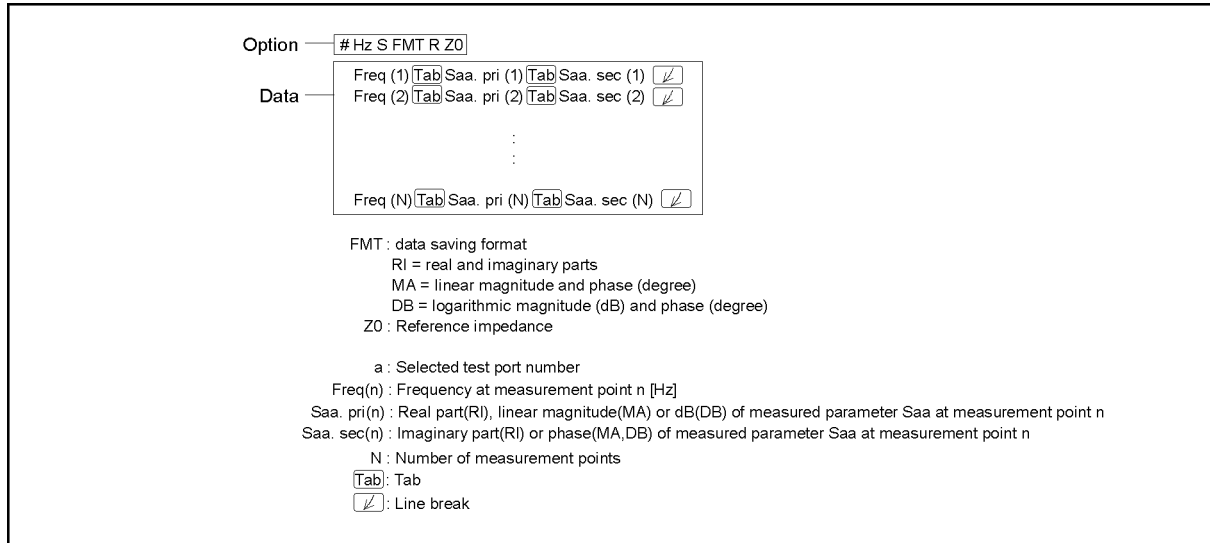

**Figure 7-6** Two port Touchstone file

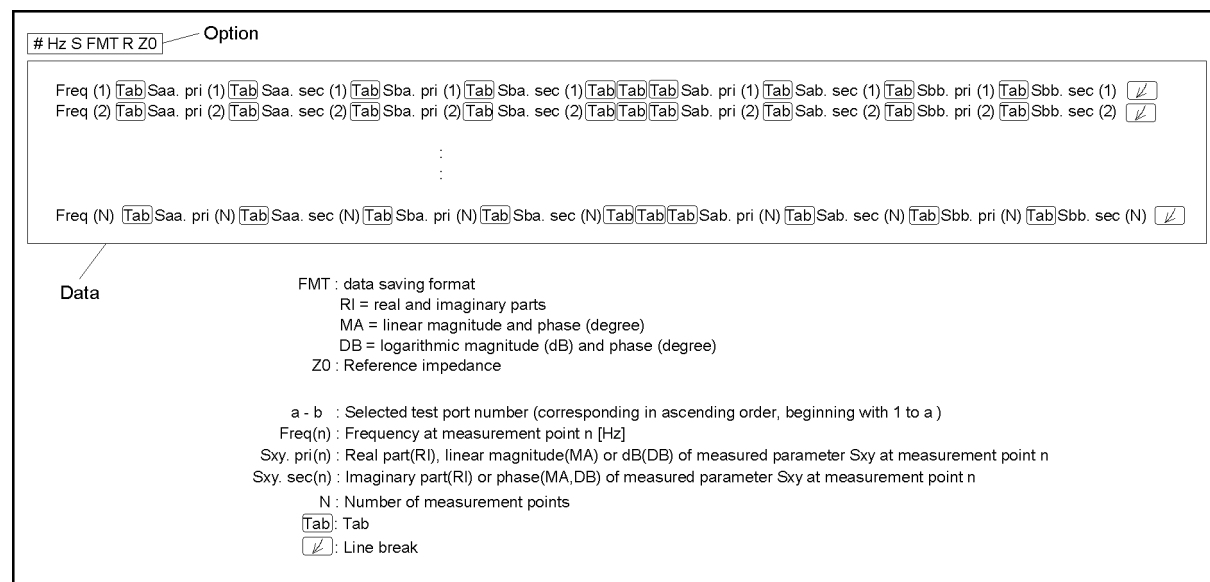



---

## Saving the Screen Image to a File

Along with printing, the E5061A/E5062A allows the user to save screen images as bitmap (.bmp) or portable network graphics (.png) files. Saved files can be loaded into PC application software for further processing.

### Saving the Screen Image to a File

Follow the procedure below to save a screen image to a file.

**Step 1.** Display the screen to be saved as a file.

---

**NOTE**

If you want to save the screen with white background, set the display mode to inverted display before you save the screen. For details about display mode, see “Selecting display mode” on page 77.

**Step 2.** Press **System** to display the System menu. Use the softkey listed below.

| Softkey                  | Function                          |
|--------------------------|-----------------------------------|
| <b>Dump Screen Image</b> | Saves the screen image to a file. |

---

**NOTE**

The screen image at the time **System**<sup>Capture</sup> is pressed is the image that will be saved. For details, see “Printed/saved images” on page 175.

**Step 3.** Press **Dump Screen Image** to open the Save As dialog box. For more information on the Save As dialog box, see the descriptions associated with Figure 7-1, “Save As Dialog Box,” on page 161. Note that “Bitmap Files (\*.bmp)” or “Portable Network Graphics (\*.png)” is selected as the file type when the dialog box first opens.

**Step 4.** Select the file type.

**Step 5.** Select the destination folder and type a file name. Press **Save** to save the screen image of E5061A/E5062A to a file.

---

## Organizing Files and Folders

You can organize files and folders (copy, move, delete, rename, or format a floppy disk) with Windows® Explorer®.

Figure 7-7

### Windows Explorer

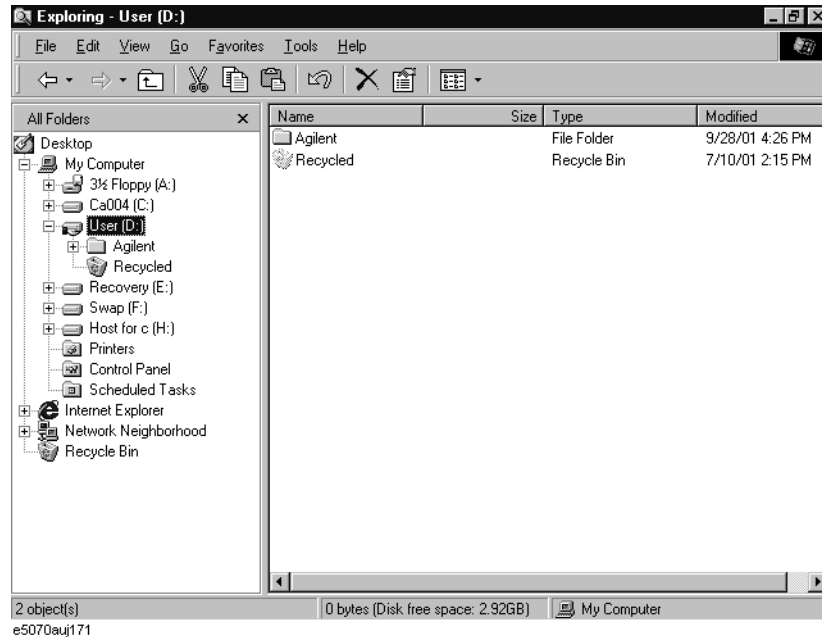

---

#### NOTE

Do not modify any files and folders in drives other than drive A: and drive D:. Doing so will cause malfunctions.

### To open Windows Explorer

**Step 1.** Press **Save/Recall**.

**Step 2.** Press **Explorer...**

### To copy a file or folder

**Step 1.** Select a source file or folder on the Windows Explorer.

**Step 2.** Select **Edit - Copy** from the menu bar.

**Step 3.** Open the destination folder.

**Step 4.** Select **Edit - Paste** from the menu bar.

### To move a file or folder

- Step 1.** Select a source file or folder on the Windows Explorer.
- Step 2.** Select **Edit - Cut** from the menu bar.
- Step 3.** Open the destination folder.
- Step 4.** Select **Edit - Paste** from the menu bar.

### To delete a file or folder

- Step 1.** Select a file or folder you want to delete on the Windows Explorer.
- Step 2.** Select **Edit - Delete** from the menu bar.

### To rename a file or folder

- Step 1.** Select a file or folder you want to rename on the Windows Explorer.
- Step 2.** Select **File - Rename** from the menu bar.
- Step 3.** Type the new name of the file or folder, and then press .

### To format a floppy disk

---

**NOTE** All files and folders in the floppy disk are erased by formatting.

- Step 1.** Put a floppy disk into the floppy disk drive that you want to format.
- Step 2.** Use the right mouse button to click the A drive in the Windows Explorer.
- Step 3.** Click **Format...** in the shortcut menu.
- Step 4.** Follow the instructions in the dialog box to format the floppy disk.

## Printing Displayed Screen

By connecting the printer to the printer parallel port or the USB port of the E5061A/E5062A, you can print the displayed screen of the E5061A/E5062A.

### Available printers (supported printers)

Table 7-2 shows the models of the available printers (supported printers) for the E5061A/E5062A, the printer drivers you need to use, and the available ports of the E5061A/E5062A.

For the latest information of the supported printers for the E5061A/E5062A, contact Agilent Technologies. When contacting us, see the list of our customer centers at the end of this manual.

**Table 7-2 Supported printers (as of February 2004)**



| Manufacturer    | Model name   | Printer driver you need to use *1 | Available port                     |
|-----------------|--------------|-----------------------------------|------------------------------------|
| Hewlett-Packard | DeskJet 5650 | HP Deskjet 5650                   | Printer parallel port and USB port |

\*1. The drivers for all supported printers at the time of shipment are installed in the E5061A/E5062A. If you use a printer newly supported after purchasing the product, you need to install the printer driver for the printer in the E5061A/E5062A. For more information on installation, refer to "Installing printer driver" on page 177.

## Printed/saved images

The display image saved in the volatile memory (clipboard) is printed/saved. If no image is saved in the clipboard, the image displayed at the execution is printed/saved.

### Saving image to clipboard

 has a screen capture feature also. When you press , the image displayed on the screen immediately before is saved in the clipboard.

---

#### NOTE

The image in the clipboard is cleared when you execute print/save.

## Print procedure

### Preparation before print

Follow these steps to make a preparation for print:

- Step 1.** Turns off the E5061A/E5062A.
- Step 2.** Turn on the printer and connect it to the E5061A/E5062A.

---

#### NOTE

Do not connect a printer that is not supported to the E5061A/E5062A.

- Step 3.** Turns on the E5061A/E5062A.
- Step 4.** Press .
- Step 5.** Press **Printer Setup** to open the printers window. Then set up the printer properly according to the printer's manual.
- Step 6.** Close the printers window.

## Data Output

### Printing Displayed Screen

#### Executing print

Follow these steps to print the screen information:

- Step 1.** Display the screen you want to print.
- Step 2.** Press  to save the currently displayed screen into the clipboard.
- Step 3.** As necessary, press **Invert Image** to toggle between [OFF] for printing in colors close to the actually displayed screen and [OFF] for printing in inverse colors.
- Step 4.** Press **Print** to start printing.

To cancel the printing in progress, press **Abort Printing**.

---

#### NOTE

If you start printing when the printer is not ready (for example, it is not turned on) by mistake, the Printers Folder dialog box as shown in Figure 7-8 may appear. In this case, click **Cancel** to finish the Printers Folder dialog box, prepare your printer, and then start printing again.

---

Figure 7-8

#### Printers Folder dialog box



## Installing printer driver

If you use a printer newly supported after purchasing the product, you need to install the printer driver for the printer in the E5061A/E5062A.

Obtain the driver specific to the E5061A/E5062A that Agilent Technologies provides.

Generally, you can download the printer driver from our product information web site of the Agilent Technologies E5061A/E5062A.

For how to obtain the printer driver, contact Agilent Technologies. To contact us, see the list of our customer centers at the end of this manual or Online assistance homepage (<http://www.agilent.com/find/assist>).

For information how to install the driver, refer to the manual that comes with the driver you obtained.

Data Output  
**Printing Displayed Screen**



---

## 8 Limit Test

This chapter describes the concepts behind the limit test and how to perform it using the Agilent E5061A/E5062A.

## Limit Test

The limit test feature allows you to set the limit line for each trace and then perform the pass/fail judgment for the measurement result.

### Concept of limit test

The limit test is a function to perform the pass/fail judgment based on the limit line you set with the limit table.

In the limit test, if the upper limit or lower limit indicated by the limit line is not exceeded, the judgment result is pass; if it is exceeded, the judgment result is fail for all measurement points on the trace. Measurement points in the stimulus range with no limit line are judged as pass.

---

#### NOTE

The targets of the pass/fail judgment are measurement points only. Parts interpolated between measurement points are not judged.

You define the limit line by specifying the stimulus value (Begin Stimulus) and response value (Begin Response) of the begin point, the stimulus value (End Stimulus) and response value (End Response) of the end point, and the type (lower limit/upper limit). For more information, refer to “Defining the Limit Line” on page 182.

When the limit test is on, measurement points that fail are displayed in red on the screen and the pass/fail judgment result of the trace based on the judgment result of individual measurement points (fail, if there is one or more measurement points that fail on the trace) is displayed also. You can check the pass/fail judgment result for the channel (fail, if there is one or more traces that fail in the channel) on the screen as well. For more information, refer to “Displaying judgment result of limit test” on page 181.

In addition to viewing the screen, you can check the judgment result of the limit test by the following methods.

- Beep that occurs when the judgment result is fail.
- Using the status register (for more information, refer to Programmer's Guide).

### Displaying judgment result of limit test

#### Judgment result of measurement points and trace

Measurement points that fail are displayed in red on the screen. The judgment result of the trace is indicated by Pass or Fail displayed in the upper right part of the graph.

Figure 8-1

#### Result display of measurement points and trace

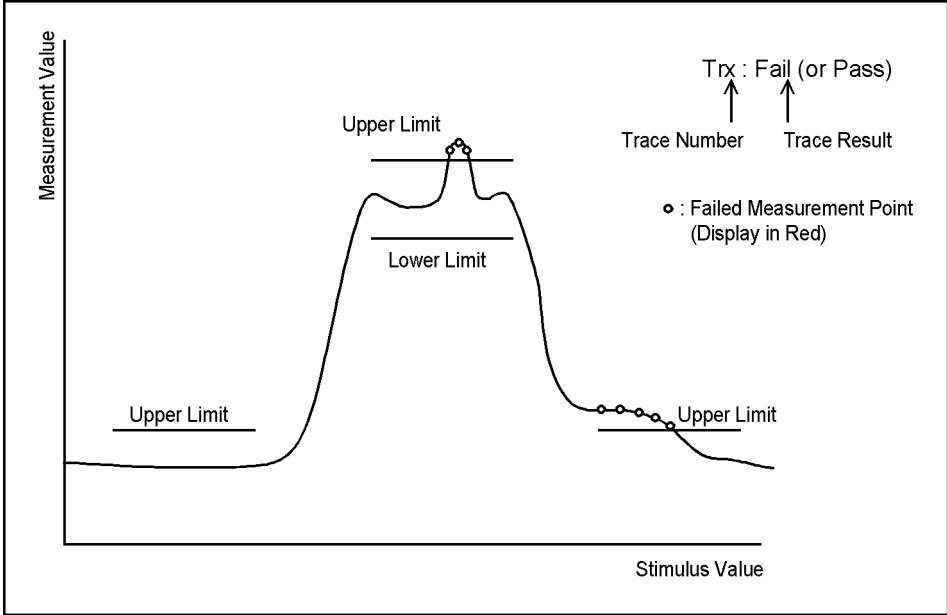

e5070bue064

#### Judgment result of channels

If there is a channel whose judgment result is fail, the message shown in Figure 8-2 appears on the screen.

Figure 8-2

#### Channel fail message

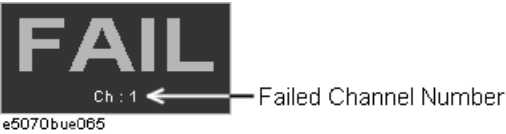

e5070bue065

Follow these steps to turn on/off the display of the channel fail message.

- Step 1. Press **Analysis**.
- Step 2. Press **Limit Test**.
- Step 3. Press **Fail Sign**. Each press toggles between on/off.

## Defining the Limit Line

To use the limit test, you must first define the limit line. You can define a limit table for each trace, and you can define up to 100 limit lines (segments) in a limit table.

### Defining a Segment

The following steps describe how to define a segment.

- Step 1.** Press **Channel Next** or **Channel Prev** to activate the channel on which the limit test function will be used.
- Step 2.** Press **Trace Next** or **Trace Prev** to activate the trace on which the limit test function will be used.
- Step 3.** Press **Analysis** to display the Analysis menu.
- Step 4.** Press **Limit Test** to display the softkeys associated with the limit test.
- Step 5.** Press **Edit Limit Line** to display the limit table shown in Figure 8-3. Using the limit table, create/edit a segment. Initially, no segments are entered in the limit table.

At the same time, the Edit Limit Line menu used to create/edit the limit table is displayed. The following lists the functions that correspond to the softkeys shown.

| Softkey                     | Function   |
|-----------------------------|--|
| <b>Delete</b>               | Deletes the segment containing the selected cell from the limit table.   |
| <b>Add</b>                  | Adds a segment before the segment containing the selected cell to the limit table.   |
| <b>Clear Limit Table</b>    | Clears all the limit table data.   |
| <b>Export to CSV File</b>   | Exports the limit table to a file in CSV (comma-separated value) format. For more information, see “Saving/Calling the Limit Table” on page 185. |
| <b>Import from CSV File</b> | Imports a limit table saved in CSV (separated-separated value) format. For more information, see “Saving/Calling the Limit Table” on page 185.   |
| <b>Return</b>               | Exits the Edit Limit Line menu and closes the limit table display.   |

Figure 8-3

Limit Table

The screenshot shows a table with 6 rows and 6 columns. Callouts point to the following elements:

- Segment number: points to the first column (1-6).
- Type of limit line: points to the second column (MAX, MIN, OFF).
- Beginning point of stimulus value: points to the third column (Begin Stimulus).
- End point of stimulus value: points to the fourth column (End Stimulus).
- Beginning point of response value: points to the fifth column (Begin Response).
- End point of response value: points to the sixth column (End Response).

| Segment number | Type | Begin Stimulus  | End Stimulus     | Begin Response | End Response |
|----------------|------|-----------------|------------------|----------------|--------------|
| 1              | MAX  | 1.000000000 MHz | 3.000000000 MHz  | -10 dB         | -20 dB       |
| 2              | MAX  | 4.000000000 MHz | 5.000000000 MHz  | -30 dB         | -30 dB       |
| 3              | MIN  | 4.000000000 MHz | 5.000000000 MHz  | -50 dB         | -50 dB       |
| 4              | MAX  | 6.000000000 MHz | 8.000000000 MHz  | -20 dB         | -10 dB       |
| 5              | OFF  | 8.000000000 MHz | 10.000000000 MHz | -10 dB         | -10 dB       |
| 6              |      |                 |                  |                |              |

e5070aue064

**Step 6.** Press **Add** to add a segment to the limit table, and then specify the segment parameter values shown below.

| Segment Parameter          | Description   |
|----------------------------|---|
| <b>Type</b>                | Select the type of segment from the following:<br>OFF Segment not used for the limit test<br>MIN The segment at which the minimum is specified<br>MAX The segment at which the maximum is specified |
| <b>Begin Stimulus</b> *1*2 | Specify the starting point for the stimulus value on the limit line.  |
| <b>End Stimulus</b> *1*2   | Specify the ending point for the stimulus value on the limit line.  |
| <b>Begin Response</b> *3*4 | Specify the starting point for the response value on the limit line.  |
| <b>End Response</b> *3*4   | Specify the ending point for the response value on the limit line.  |

\*1. The range in which stimulus values can be specified is from -500 G to +500 G. When a value outside the range is entered, a suitable value within the range is specified.  
 \*2. Once the stimulus value is specified, changing the sweep range of the E5061A/E5062A does not affect the stimulus value.  
 \*3. The range in which response values can be specified is from -500 M to +500 M. When a value outside the range is entered, a suitable value within the range is specified.  
 \*4. After the response value is specified, changing formats results in changing the units but not the value.

Figure 8-4

Example of limit lines (when the limit table is set as Figure 8-3)

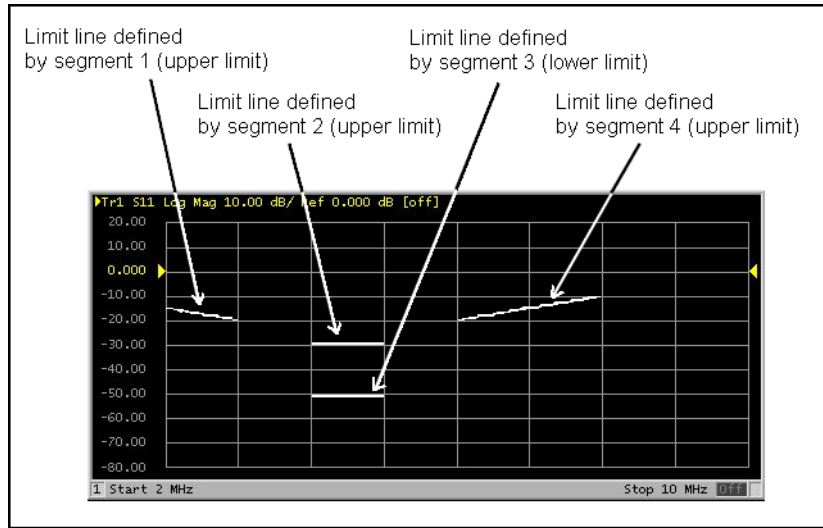

e5070bue063

**NOTE**

You can define a limit line that is able to freely overlap with the stimulus range of another limit line.

Defining one limit line having the same type as a second limit line whose stimulus range overlaps with the first one results in two or more limit values at the same measurement point. In this case, the limit value to be used in the limit test is defined as follows:

- When two or more limit values whose type is set to maximum (MAX) exist, the smallest one is used as the maximum.
- When two or more limit values whose type is set to minimum (MIN) exist, the largest one is used as the minimum.

**NOTE**

Even if the span of the sweep range on the E5061A/E5062A is set 0, enter the two parameters, Begin Stimulus and End Stimulus.

**NOTE**

When two or more response values are returned as a result of using the Smith or polar chart format, the first response value of the marker provides the object of the limit test.

### Saving/Calling the Limit Table

You can save the limit table to a file, which you can then freely bring up on the screen later and use. You can import a file saved in CSV format (extension: \*.csv) into spreadsheet software on a PC for later use. (A numerical value will be saved as strings including its unit).

The limit table is saved in the following format.

#### Example 8-1

#### Limit Table Saved in CSV Format

```
"# Channel 1"  
"# Trace 1"  
Type, Begin Stimulus, End Stimulus, Begin Response, End Response  
MAX, 200.0000000 MHz, 400.0000000 MHz, -100 dB, -100 dB  
MAX, 490.0000000 MHz, 510.0000000 MHz, -10 dB, -10 dB  
MIN, 490.0000000 MHz, 510.0000000 MHz, -20 dB, -20 dB  
MIN, 600.0000000 MHz, 800.0000000 MHz, -100 dB, -100 dB
```

On the first line, the channel number of the active channel that was valid when the file was saved is output.

On the second line, the trace number of the active trace that was valid when the file was saved is output.

The third line provides the header showing the items for the segments to be output on the fourth and later lines.

Data on segments are output on the fourth and later lines.

### Saving/Calling the Limit Table

The following steps describe how to save/call the limit table. Use the external keyboard and mouse for the operations described below.

- Step 1.** Display the limit table.
- Step 2.** In the Edit Limit Line menu, press **Export to CSV File** to open the Save As dialog box. For more information on the Save As dialog box, refer to the description provided in Figure 7-1, "Save As Dialog Box," on page 161. In this step, CSV Files (extension: \*.csv) are selected as the file type.
- Step 3.** Specify the folder in which to save the file, and enter the file name. Press **Save** to save the limit table displayed on the screen to the file.
- Step 4.** Conversely, to recall a saved limit table, press **Import from CSV File** in the Edit Limit Line menu to display the Open dialog box. For a description of parts of the Open dialog box, see Figure 7-2, "Input from Front Panel," on page 162. In this step, CSV Files (extension: \*.csv) are selected as the file type.
- Step 5.** After specifying the folder containing the file, select the file. Press **Open** to display the limit table on the screen.

---

#### NOTE

You can recall a limit table from a trace on any channel independently of the channel and trace that were active when the limit table was saved to the file.

---

## Changing the limit line display method

You can specify the limit line display method to show/hide limit values that are not used for evaluation. The limit line setting method and evaluation method are the same.

### Operational procedure

Follow these steps to set the display method.

- Step 1.** Press **Channel Next** or **Channel Prev** to activate the channel for which you want to use the limit test function.
- Step 2.** Press **Trace Next** or **Trace Prev** to activate the trace for which you want to use the limit test function.
- Step 3.** Press **Analysis** to display the Analysis menu.
- Step 4.** Press **Limit Test**.
- Step 5.** Turn off **Limit Line**.
- Step 6.** Press **Clip Lines** to toggle on/off.

| Softkey | Function                      |
|---------|-------------------------------|
| ON      | Displays clipped limit lines. |
| OFF     | Displays entire limit lines.  |

Figure 8-5

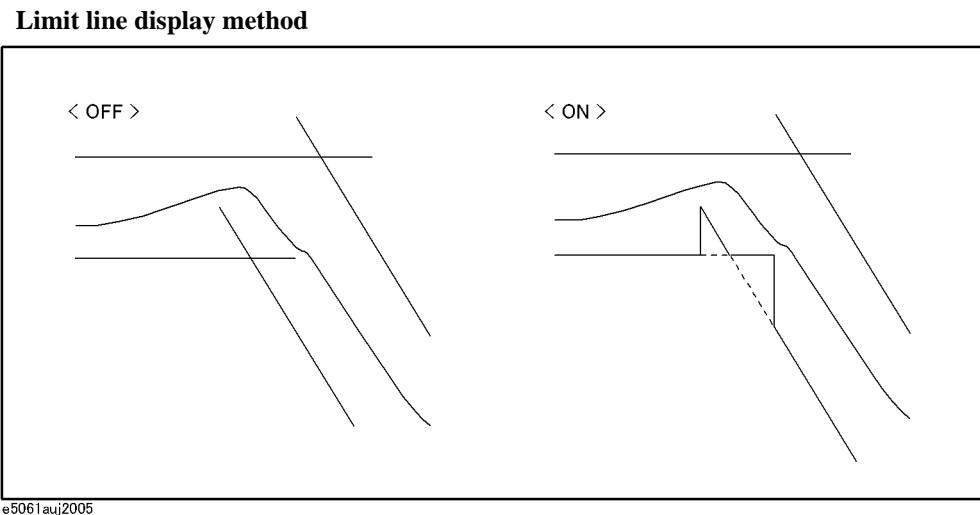



## Turning the Limit Test ON/OFF

You can set the limit test ON/OFF for each trace individually.

### Setting the Limit Test ON/OFF

The following steps describe how to set the limit test ON/OFF.

- Step 1.** Press **Channel Next** or **Channel Prev** to activate the channel on which the limit test function will be used.
- Step 2.** Press **Trace Next** or **Trace Prev** to activate the trace on which the limit test function will be used.
- Step 3.** Press **Analysis** to display the Analysis menu.
- Step 4.** Press **Limit Test** to display the Limit Test menu.

| Softkey                | Function  |
|------------------------|---|
| <b>Limit Test</b>      | Sets the limit test ON/OFF.                                     |
| <b>Limit Line</b>      | Sets the limit line display ON/OFF.                             |
| <b>Edit Limit Line</b> | Opens the limit table for editing the limit line.* <sup>1</sup> |

\*1. To use the limit test function, you must first define the limit line. For more on how to define the limit line, see “Defining the Limit Line” on page 182.

- Step 5.** Press **Limit Test** to turn the limit test ON. To display the limit line on the screen, press **Limit Line**.

## Initializing the Limit Table

The following operations initialize the limit table.

- At power-on
- When presetting
- When calling a limit table with zero segments
- When **Clear Limit Table - OK** is pressed in the Edit Limit Line menu

## Offsetting trace data

This section describes how to track the peak value or a specified frequency on a trace. After a sweep, the point to be tracked is set as the Y-axis reference value by offsetting measurement values. Because measurement values are offset, marker values and limit test evaluation results change accordingly.

### Operational procedure

Follow these steps to offset trace data.

- Step 1.** Press **Channel Next** or **Channel Prev** to activate the channel for which you want to offset trace data.
- Step 2.** Press **Trace Next** or **Trace Prev** to activate the channel for which you want to offset trace data.
- Step 3.** Press **Scale**.
- Step 4.** Press **Reference Tracking**.
- Step 5.** When you want to specify a measurement value at a frequency as the Y-axis reference value for tracking, enter the frequency in **Track Frequency**.
- Step 6.** Press **Tracking** to select a tracking method.

| Softkey    | Function  |
|------------|---|
| OFF        | Does not offset trace data.   |
| Track Peak | Sets the peak value after the sweep as the reference value.               |
| Track Freq | Sets a measurement value at a specified frequency as the reference value. |

---

**NOTE** This function is available even when the limit test function is off.

Figure 8-6

When tracking is off

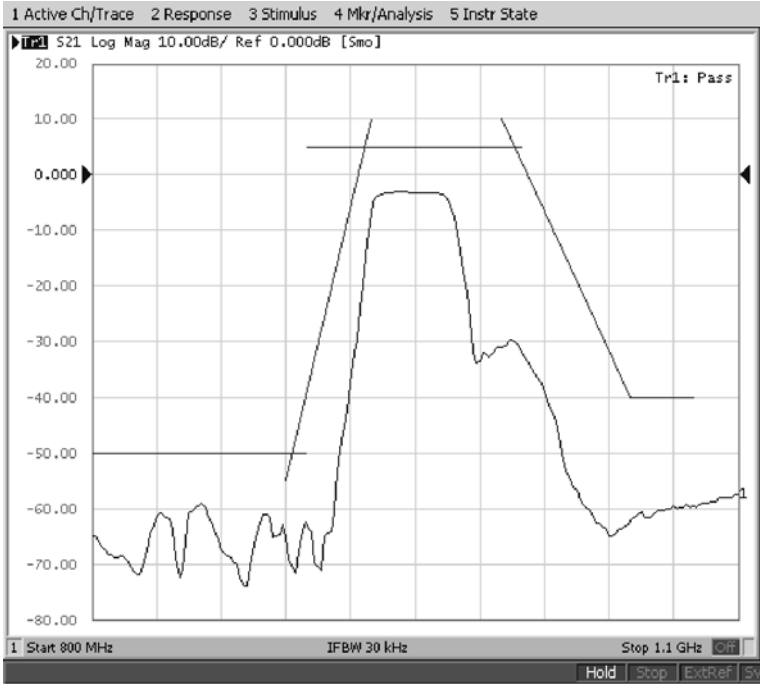

The trace is not offset.

Figure 8-7

Peak tracking (on)

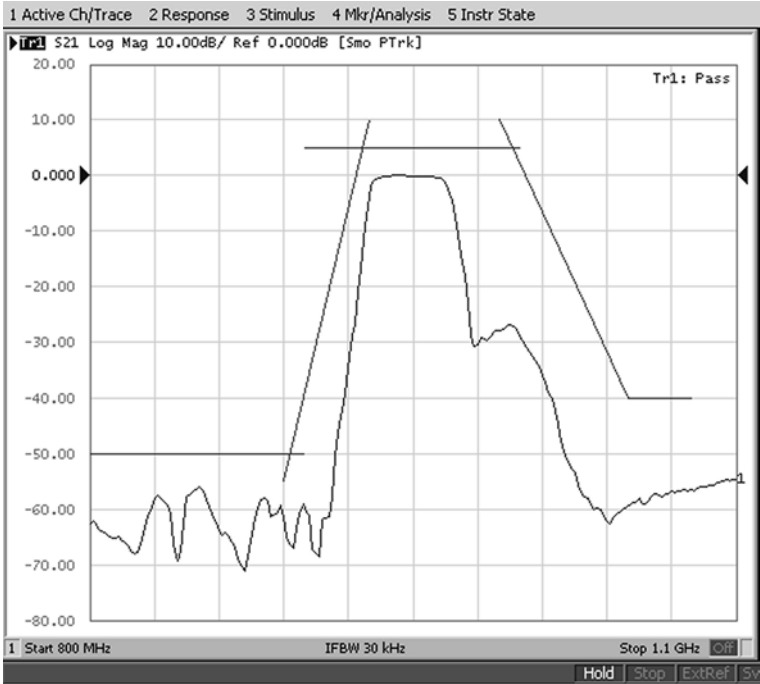

The peak point of the trace is set as the Y-axis reference value (0.000).

8. Limit Test

Figure 8-8

Frequency tracking (on)

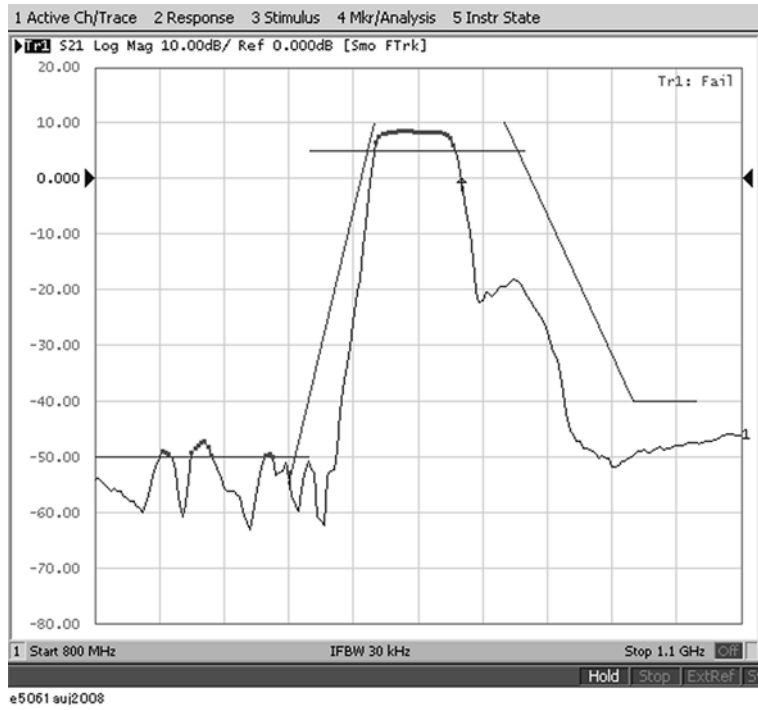

The measurement value of the specified frequency point is set as the Y-axis reference value (0.000).

---

**9****Optimizing Measurements**

This chapter describes how to optimize your measurements when using the Agilent E5061A/E5062A.

## Expanding the Dynamic Range

The dynamic range is the finite difference between the maximum input power level and the minimum measurement power level (noise floor) of the analyzer. In evaluating a characteristic accompanied by a large change in the amplitude (the pass band and stop band of a filter, for example), it is important to increase the dynamic range.

### Lowering the Receiver Noise Floor

Lowering the noise floor of the receiver enables you to enlarge the dynamic range. The following methods can be used to lower the receiver noise floor.

- “Narrowing the IF Bandwidth” on page 192
- “Turning on Sweep Averaging” on page 193

### Narrowing the IF Bandwidth

Narrowing the receiver IF bandwidth enables you to reduce the effect of random noise on measurements. Narrowing the IF bandwidth to 1/10 the original bandwidth causes the receiver noise floor to decrease by 10 dB.

Figure 9-1

### Effects of Narrowing the IF Bandwidth

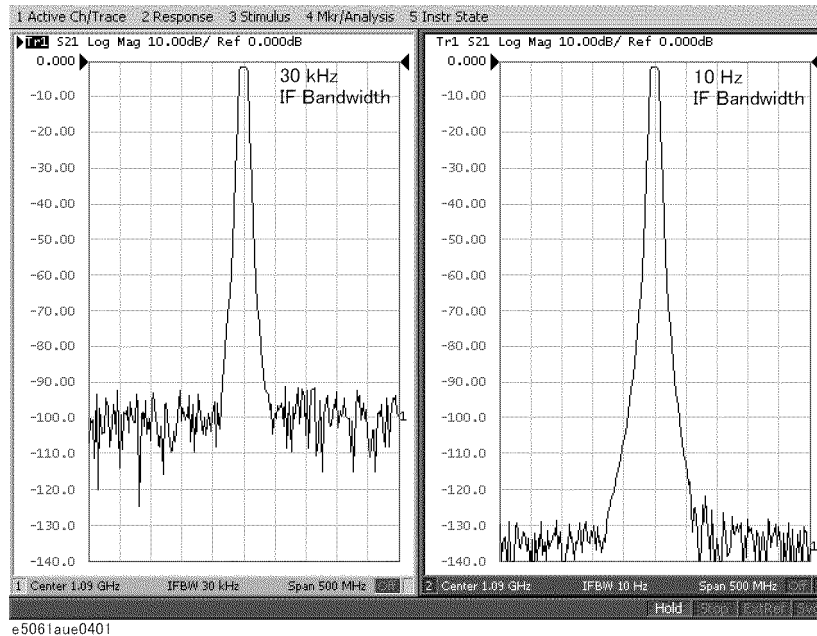

To specify the IF bandwidth, follow the steps described below.

- Step 1.** Press **Channel Next** or **Channel Prev** to select a channel on which to specify the IF bandwidth.
- Step 2.** Press **Avg**.
- Step 3.** Press **IF Bandwidth**.

**Step 4.** Change the IF bandwidth in the data entry area.

### Turning on Sweep Averaging

Using sweep averaging also enables you to reduce the effects of random noise on measurements.

Sweep averaging averages data from each point (vector quantity) based on the exponential average of a continuous sweep weighted by the averaging factor specified by the user. Sweep averaging is expressed in Equation 9-1.

**Equation 9-1**

### Sweep Averaging

$$A_n = \frac{S_n}{F} + \left(1 - \frac{1}{F}\right) \times A_{n-1}$$

where:

$A_n$  = Result of the calculation of sweep averaging for the  $n$ th sweep operation at the point in question (a vector quantity).

$S_n$  = Measurement value obtained at the  $n$ th sweep operation at the point in question (a vector quantity).

$F$  = Sweep averaging factor (an integer between 1 and 999)

**Figure 9-2**

### Effects of Sweep Averaging

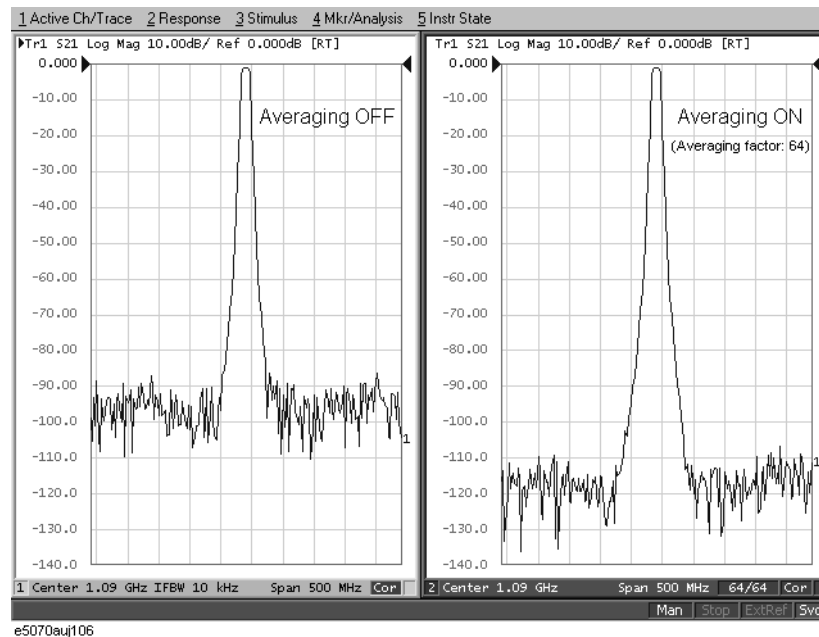

Define the sweep averaging by following the steps below.

- Step 1.** Press **Channel Next** or **Channel Prev** to select a channel on which the sweep averaging will be defined.
- Step 2.** Press **Avg**.
- Step 3.** Press **Avg Factor**.
- Step 4.** Change the averaging factor in the data entry area.
- Step 5.** Press **Averaging** to turn **ON** the averaging.

---

**NOTE**

Pressing **Averaging Restart** resets  $n$  to 1 in Equation 9-1 on page 193.



## Reducing Trace Noise

Any of the following methods can be used to lower the trace noise.

- Turning on sweep averaging
- Turning on smoothing
- Narrowing the IF bandwidth

For more about sweep averaging and the IF bandwidth, see “Turning on Sweep Averaging” on page 193 and “Narrowing the IF Bandwidth” on page 192.

### Turning on Smoothing

Smoothing can be used to reduce noise having relatively small peaks. By turning on smoothing, the value of each point on a trace is represented by the moving average over the values of several nearby points. The smoothing aperture (percentage of sweep span) defines the range of points to be included in the calculation of the moving average.

**NOTE** You can define the smoothing trace by trace.

**Figure 9-3** Effects of Smoothing (Log Magnitude Format)

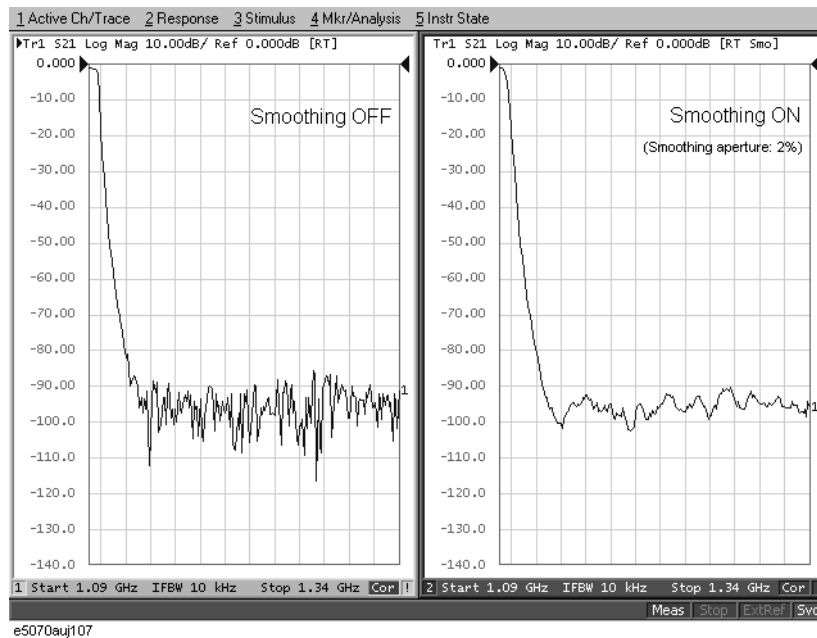
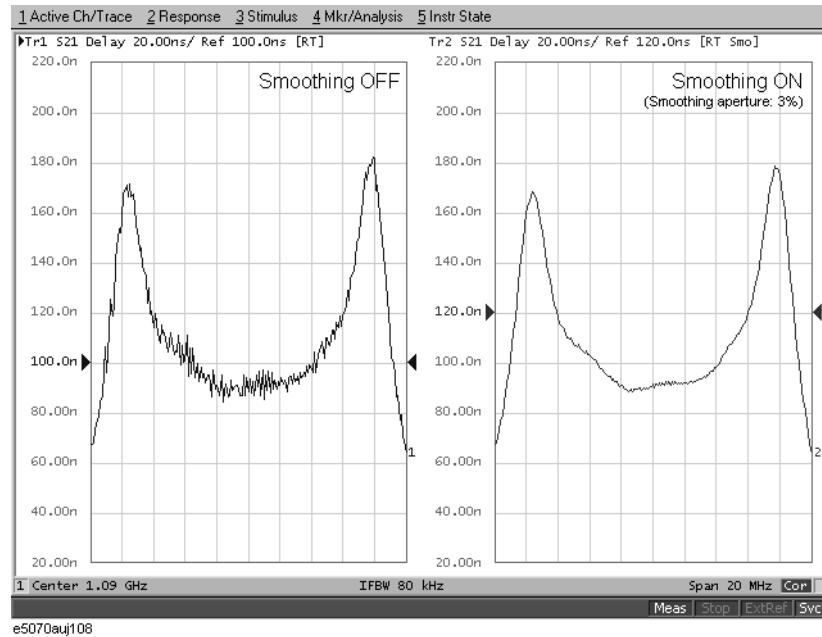

Figure 9-4

Effects of Smoothing (Group Delay Format)



### Setting Up Smoothing

Setup the smoothing operation by following the steps below.

- Step 1.** Press **Channel Next** (or **Channel Prev**) and **Trace Next** (or **Trace Prev**) to activate the trace on which smoothing will be defined.
- Step 2.** Press **Avg**.
- Step 3.** Press **Smo Aperture**.
- Step 4.** Change the smoothing aperture (%) in the data entry area.
- Step 5.** Press **Smoothing** to turn **ON** the smoothing.

---

## Improving the Accuracy of Phase Measurements

This section describes the following functions that can be used to improve phase measurement accuracy.

- “Electrical Delay” on page 197
- “Port Extension” on page 198
- “Phase Offset” on page 199

### Electrical Delay

Electrical Delay is a function that adds or removes a pseudo-lossless transmission line with a variable length against the receiver input. Using this function enables you to improve the resolution in phase measurement and thereby measure deviation from the linear phase. You can specify the electrical delay trace by trace.

#### Procedure

- Step 1.** Press **Channel Next** (or **Channel Prev**) and **Trace Next** (or **Trace Prev**) to activate the phase trace for which the electrical delay will be specified.
- Step 2.** Press **Scale**.
- Step 3.** Press **Electrical Delay**.
- Step 4.** Change the electrical delay (in seconds) in the data entry area.

For how to determine the deviation from a linear phase, see “Measuring the Deviation from a Linear Phase” on page 255.

#### Procedure using marker

- Step 1.** Press **Channel Next** (or **Channel Prev**) and **Trace Next** (or **Trace Prev**) to activate a trace for which you want to set the electrical delay.
- Step 2.** Place the active marker to an appropriate position.
- Step 3.** Press **Marker Fctn**.
- Step 4.** Press **Marker** → **Delay** to set the electrical delay to the value of the group delay at the position of the active marker (a value smoothed with the aperture of 20% regardless of the setting of smoothing).

---

#### NOTE

An absolute value is used regardless of on/off of the reference marker mode.

## Port Extension

Port Extension is a function for moving the calibration reference plane by specifying the electrical delay. This function is useful, for example, when you cannot perform calibration at the DUT terminal directly because the DUT is inside the test fixture. In such a case, this function enables you to first perform calibration at the test fixture terminal and then move the calibration plane to the DUT terminal by extending the port.

Port extension corrects the electrical delay of each test port (phase shift) only. It cannot remove errors caused by the loss in and wrong matching of cables, adapters, or test fixtures.

---

**NOTE**

---

You can define port extension channel by channel. Even if you set port extension for a channel, it does not affect to the other channels.

### Using the Port Extension Function

- Step 1.** Press  or  to activate the channel for which port extension will be specified.
- Step 2.** Press .
- Step 3.** Press **Port Extensions**.
- Step 4.** Specify the port extension for each test port.

| Softkey                               | Function   |
|---------------------------------------|--|
| <b>Extension Port 1</b>               | Specify the port extension (in seconds) for test port 1. |
| <b>Extension Port 2</b>               | Specify the port extension (in seconds) for test port 2. |
| <b>Extension Port 3</b> <sup>*1</sup> | Specify the port extension (in seconds) for test port 3. |
| <b>Extension Port 4</b> <sup>*2</sup> | Specify the port extension (in seconds) for test port 4. |

\*1. Only with Options 313, 314, 413, and 414.

\*2. Only with Options 413 and 414.

## Phase Offset

Phase Offset is a function used to add or subtract a predetermined value relative to the frequency to and from the trace. Using this function enables you to simulate the phase offset occurring as a result of, say, adding a cable.

The phase offset can be specified from  $-360^\circ$  to  $+360^\circ$ .

### Using the Phase Offset Function

- Step 1.** Press **Channel Next** (or **Channel Prev**) and **Trace Next** (or **Trace Prev**) to activate the trace for which the phase offset will be specified.
- Step 2.** Press **Scale**.
- Step 3.** Press **Phase Offset**.
- Step 4.** Enter the phase offset ( $^\circ$ ) in the data entry area.

## Specifying the Velocity Factor

The velocity factor is the ratio of the propagation velocity of a signal in a coaxial cable to the propagation velocity of that signal in free space. The velocity factor for a common cable is about 0.66. The propagation velocity depends on the dielectric constant ( $\epsilon_r$ ) of the dielectric substance in the cable.

$$\text{Velocity factor} = \frac{1}{\sqrt{\epsilon_r}}$$

By specifying the velocity factor, you can match the equivalent length (in meters) appearing in the data entry area to the actual physical length when using the “Electrical Delay” on page 197 or “Port Extension” on page 198 to specify the electrical delay (in seconds).

You can define the velocity factor channel by channel.

### Using the Velocity Factor

- Step 1.** Press **Channel Next** or **Channel Prev** to activate the channel for which the velocity factor will be specified.
- Step 2.** Press **Cal**.
- Step 3.** Press **Velocity Factor**.
- Step 4.** Enter the velocity factor in the data entry area.

## Improving the Measurement Throughput

This section explains how to improve the measurement throughput by turning off the updating of information displayed on the LCD screen.

### Turning Off the Updating of Information Displayed on the LCD Screen

Turning off the updating of information displayed on the LCD screen causes the processing time required to update displays within the analyzer to be omitted, improving measurement throughput. If it is not necessary to check displayed information during measurements, turning off real-time updating is an effective means of improving throughput.

The updating of information displayed on the LCD screen can be switched using the following procedure:

#### Turning Off the Updating of Information

- Step 1.** Press **Display**.
- Step 2.** Press **Update** to switch the updating of displayed information on the LCD screen on/off.

When the LCD screen update is turned off, **Update Off** appears on “4. Instrument Status Bar” on page 34.

## Performing a Segment-by-Segment Sweep (Segment Sweep)

This section describes the concept of the segment sweep and how to perform it.

### Concept of the Segment Sweep

To perform a segment sweep, you must define two or more frequency ranges called segments, and then specify the number of points, IF bandwidth, power level, sweep delay time, and sweep time for each segment. All segments are swept sequentially as if swept in one sweep operation.

- By skipping the frequency range, which does not need to be measured, you can sweep and measure only the portions you need.
- You can define the optimum measurement conditions for each of the segments you designate. For example, you can specify as many points as possible in a segment requiring high trace resolution and as few points as possible in a segment not requiring high resolution. This shortens the measurement time, enabling you to enhance the overall measurement throughput without the entire measurement operation being drawn into the measurement conditions at a particular frequency range.

To evaluate a band pass filter having the transmission characteristics shown in Figure 9-5, for example, you can select the frequency ranges you need from A through G and determine the measurement conditions shown in the Table . This enables you to measure them simultaneously in one sweep operation.

**Figure 9-5**

**Characteristics of a DUT on which a Segment Sweep Will be Performed**

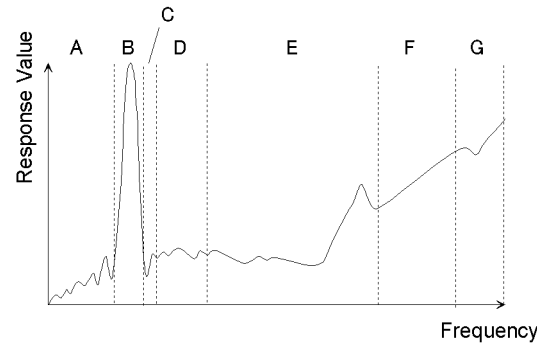

e5070aue097

**Table 9-1**

**Frequency Ranges (Segments) From Figure 9-5 and Their Measurement Conditions**

|   | Start Frequency | Stop Frequency | Number of Points | IF Bandwidth |
|---|-----------------|----------------|------------------|--------------|
| A | 440 MHz         | 915 MHz        | 50               | 10 kHz       |
| B | 915 MHz         | 980 MHz        | 130              | 30 kHz       |
| C | 980 MHz         | 1.035 GHz      | 60               | 10 kHz       |
| E | 1.07 GHz        | 2 GHz          | 100              | 30 kHz       |
| G | 2.6 GHz         | 3 GHz          | 40               | 30 kHz       |

### Conditions for Setting Up a Segment Sweep

The following conditions apply when setting up a segment sweep.

- The frequency range of a segment must not overlap with that of another segment. (The start frequency of a segment must be higher than the stop frequency of the immediately preceding segment.)
- The start frequency of segment 1 must be greater than 300 kHz and the stop frequency of the last segment less than 3 GHz (E5070A) or 8.5 GHz (E5071A).
- When the start frequency and stop frequency of a segment are not the same, you can define from 2 to 1601 points in a segment.
- When the start frequency and stop frequency of a segment are the same, you can define from 1 to 1601 points in a segment.
- You can set the total number of points in the segment table from 2 to 1601.
- You can set the number of points in the segment table to between 1 and 201.

### Items that can be set for each segment

For the segment sweep, you can set the sweep range, the number of points, IF bandwidth, power level, sweep delay time, and sweep time for each segment.

You can set the items in the following table to ON/OFF for each segment. If you enable the segment-by-segment setting, you can make the setting for each segment in the segment table; if you disable it, the setting in the following table is used.

| Item             | When segment-by-segment setting is disabled  |
|------------------|--|
| IF bandwidth     | For all the segments, the IF bandwidth for the linear/log sweep (set with <input type="text" value="Avg"/> - <b>IF Bandwidth</b> ) is set. |
| Power level      | For all the segments, the power level for the linear/log sweep (set with <input type="text" value="Sweep Setup"/> - <b>Power</b> ) is set. |
| Sweep delay time | For all the segments, 0 is set.  |
| Sweep time       | For all the segments, the auto sweep time mode is set.   |



### Sweep Delay Time and Sweep Time in a Segment Sweep

The definitions for both sweep delay time and sweep time, which you can specify in the segment sweep, are shown in Figure 9-6.

**Figure 9-6** Sweep delay time and sweep time in segment sweep

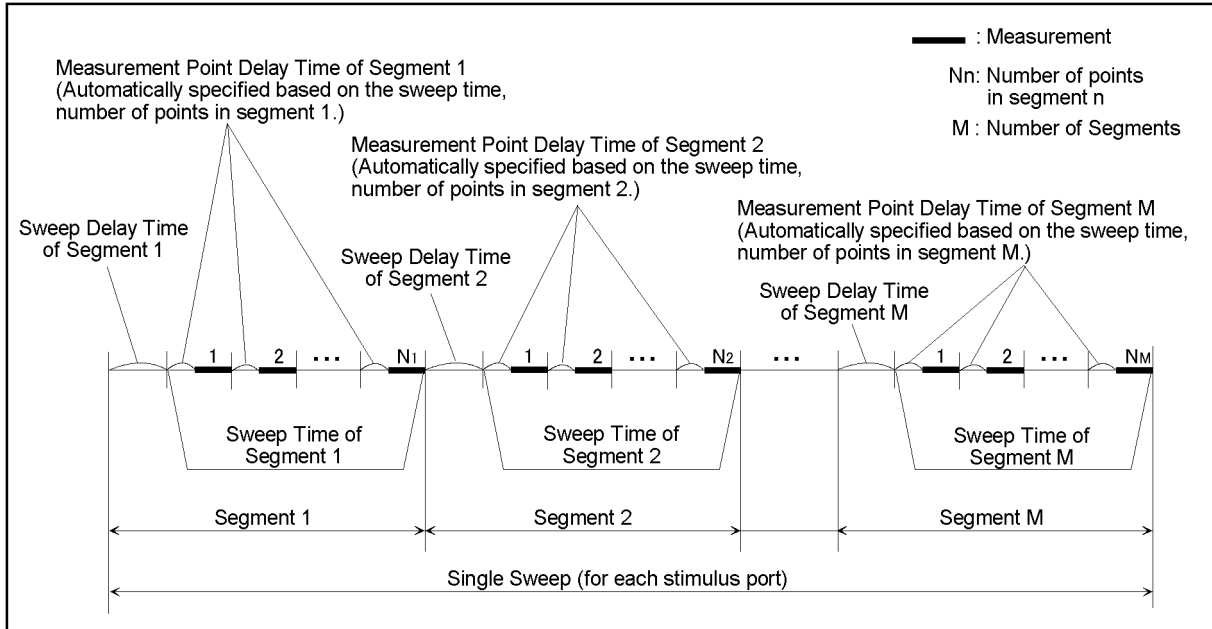

e5070aue098

### Frequency Base Display and Order Base Display

You can choose between frequency base and order base as the method of displaying traces when executing the segment sweep.

**Figure 9-7** Concept of Segment Display

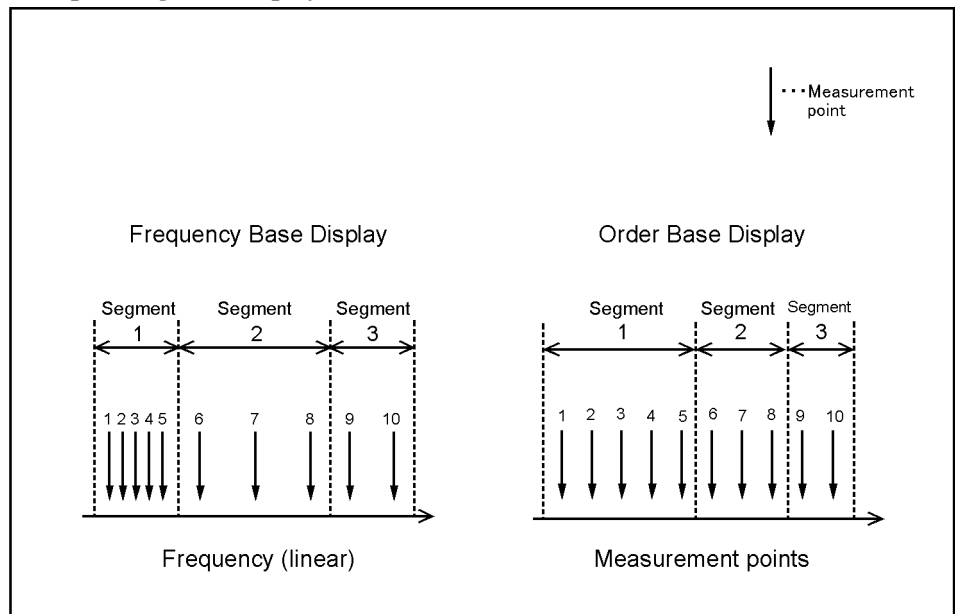

e5070aue105

# Optimizing Measurements

## Performing a Segment-by-Segment Sweep (Segment Sweep)

Figure 9-8 Comparing Methods of Displaying Segments

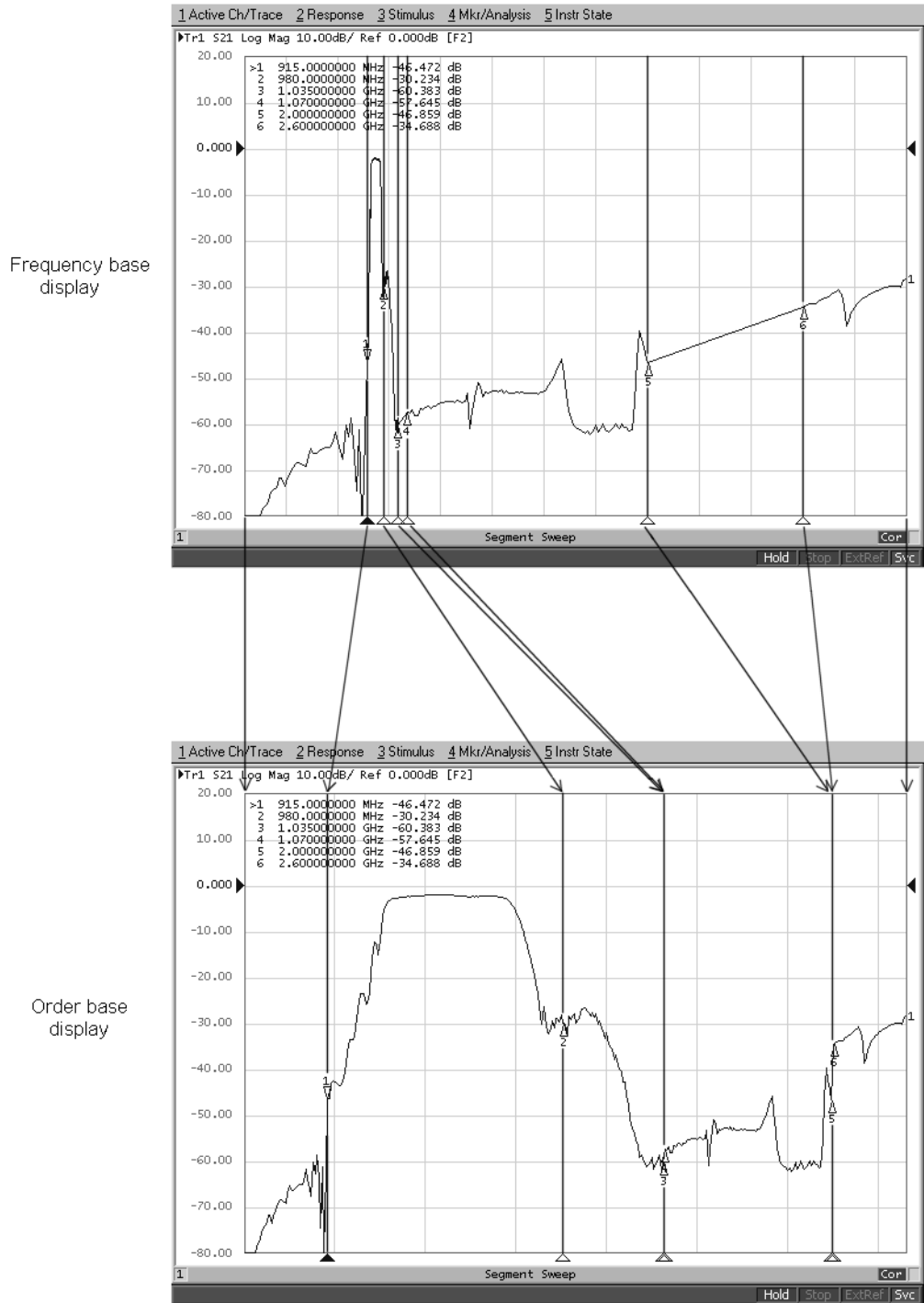

e5070aue103

## Procedure

### Creating a Segment Table

**Step 1.** Press **Channel Next** or **Channel Prev** to select the channel for which you want to create the segment table.

**Step 2.** Press **Sweep Setup**.

**Step 3.** Press **Edit Segment Table**.

The segment table appears in the lower part of the screen.

**Step 4.** To change the frequency range setting mode or to set the IF bandwidth, power level, sweep delay time, and sweep time for each segment, use the following softkeys.

---

#### NOTE

When setting the segment table using the front panel keys or keyboard, you need to place focus on (select) the operation target (segment table of softkey) first. You can change the focus by pressing **Focus** in the ENTRY block. When the focus is placed on the segment table, the window frame of the segment table is displayed as bright as the window frame of the active channel. When the focus is placed on the softkey menu, the softkey menu title area is displayed in blue.

---



| Softkey           | Function   |
|-------------------|--|
| <b>Freq Mode</b>  | Switches the frequency range setting mode (start/stop or center/span).   |
| <b>List IFBW</b>  | Toggles ON/OFF the IF bandwidth setting for each segment. Only when this setting is ON, the row ( <b>IFBW</b> ) for setting appears in the segment table.      |
| <b>List Power</b> | Toggles ON/OFF the power level setting for each segment. Only when this setting is ON, the row ( <b>Power</b> ) for setting appears in the segment table.      |
| <b>List Delay</b> | Toggles ON/OFF the sweep delay time setting for each segment. Only when this setting is ON, the row ( <b>Delay</b> ) for setting appears in the segment table. |
| <b>List Time</b>  | Toggles ON/OFF the sweep time setting for each segment. Only when this setting is ON, the row ( <b>Time</b> ) for setting appears in the segment table.        |

**Performing a Segment-by-Segment Sweep (Segment Sweep)**

**Step 5.** Repeat entering each item in the following table and adding a segment (line) to create the segment table.

|               |  |
|---------------|--|
| <b>Start</b>  | Set the start value of the sweep range.  |
| <b>Stop</b>   | Set the stop value of the sweep range.   |
| <b>Center</b> | Set the stop value of the sweep range.   |
| <b>Span</b>   | Set the span value of the sweep range.   |
| <b>Points</b> | Set the number of points.  |
| <b>IFBW</b>   | Set the IF bandwidth.  |
| <b>Power</b>  | Set the power level. The power range is common to the setting for the linear/log sweep ( <b>Sweep Setup</b> - <b>Power Ranges</b> ). |
| <b>Delay</b>  | Set the sweep delay time.  |
| <b>Time</b>   | Set the sweep time. To specify the auto setting ( <b>AUTO</b> ), enter 0 as the sweep time.  |

To create the segment table, use the following keys.

| <b>Hardkey</b>  | <b>Function</b>   |
|---|---|
|    | If you select a cell and then press this key, you enter into the mode in which you can edit the cell character by character. If you change a value and then press this key, the value is entered into the cell. |
|  | Move up and down in the cell selected in the segment table. In the character-by-character edit mode, you can select an item or perform the step change of data.   |
|  | Move right and left in the cell selected in the segment table.  |
| <b>Softkey</b>  | <b>Function</b>   |
| <b>Delete</b>   | Deletes the line in which the selected cell is included.  |
| <b>Add</b>  | Adds a new line above the line in which the selected cell is included.  |
| <b>Clear Segment Table - OK</b>   | Resets the segment table. As a result, segment 1 that is initialized remains.   |

**Figure 9-9** Example of creating segment table

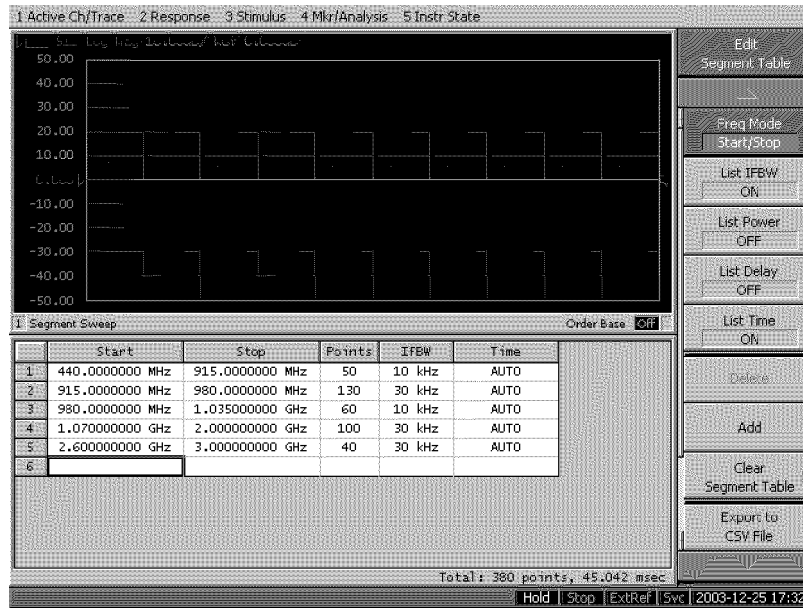

**Useful functions when using a mouse**

By right-clicking on the selected cell, you can use the following shortcut menu.

| Shortcut      | Function  |
|---------------|---|
| <b>Copy</b>   | Copies the value in the selected cell into the clipboard (internal temporary storage memory). |
| <b>Paste</b>  | Pastes the value data in the clipboard to a newly selected cell.                              |
| <b>Insert</b> | Adds a new line above the selected cell.  |
| <b>Delete</b> | Deletes the line in which the selected cell is included.                                      |

In the character-by-character edit mode, you can use the following shortcut menu also.

| Shortcut          | Function   |
|-------------------|--|
| <b>Undo</b>       | Undoes the change and restore the value before the change.                   |
| <b>Cut</b>        | Cuts the selected string and store it into the clipboard (temporary memory). |
| <b>Copy</b>       | Copies the selected string into the clipboard.                               |
| <b>Paste</b>      | Pastes the string in the clipboard to a newly selected cell.                 |
| <b>Delete</b>     | Deletes the selected string.   |
| <b>Select All</b> | Selects the entire string in the cell.                                       |

### Executing Segment Sweep

To execute a segment sweep by using the segment table you have created, you must specify the sweep type for that sweep operation by following the steps described below.

- Step 1.** Press **Channel Next** or **Channel Prev** to select the channel on which you will execute the segment sweep operation.
- Step 2.** Press **Sweep Setup**.
- Step 3.** Press **Sweep Type**.
- Step 4.** Press **Segment**.

### Setting Up the Segment Display

Define the method of displaying traces when the segment sweep is executed by following the steps described below.

- Step 1.** Press **Channel Next** or **Channel Prev** to select the channel on which you will define the segment display.
- Step 2.** Press **Sweep Setup**.
- Step 3.** Press **Segment Display**.
- Step 4.** Select segment display.

| Softkey           | Function   |
|-------------------|--|
| <b>Freq Base</b>  | Displays the X-axis as the axis for linear frequencies (frequency base display). |
| <b>Order Base</b> | Displays the X-axis as the axis for the points (order base display).             |

**Saving a Newly Created Segment Table in CSV Format**

As discussed in “Creating a Segment Table” on page 205, you can export the newly created segment table as a CSV (comma-separated value) formatted file (so it can be used easily in software that requires a different format).

- Step 1.** Press **Sweep Setup**.
- Step 2.** Press **Edit Segment Table**.
- Step 3.** Press **Export to CSV File** to open the Save As dialog box. For more information on the Save As dialog box, see Figure 7-1, “Save As Dialog Box,” on page 161. Note that “CSV Files (\*.csv)” will already be selected as the file type when the dialog box first opens.
- Step 4.** Type the file name in the **File Name** area, and press **Save** to save the segment table.

**Calling a Segment Table Saved in CSV Format**

By importing a segment table created following the steps described in “Saving a Newly Created Segment Table in CSV Format” on page 209 (inputting a file in a different software format), you can set up the segment table.

---

**NOTE**

It is possible to recall a file from a different channel where it was saved.

- Step 1.** Press **Sweep Setup**.
- Step 2.** Press **Edit Segment Table**.
- Step 3.** Press **Import from CSV File** to open the Open dialog box. For more information on the Open dialog box, see Figure 7-3, “Open Dialog Box,” on page 163. Note that “CSV Files (\*.csv)” will already be selected as the file type when the dialog box first opens.
- Step 4.** Select the CSV format file to be imported, and press **Open** to call up the segment table.

---

**NOTE**

You cannot import a CSV-formatted file created/edited in spreadsheet software into the E5061A/E5062A. Furthermore, you cannot import a CSV format file exported following the steps described in “Saving a Newly Created Segment Table in CSV Format” on page 209 if a change has been made to that file.





---

---

# 10

## Setting and Using the Control and Management Functions

This chapter describes how to set and use the control and management functions not directly linked with measurement or analysis.

## Setting the GPIB

This section describes how to set the interface necessary to use the GPIB (General Purpose Interface Bus) of the E5061A/E5062A. For information on the concept and concrete implementation of the auto measurement using GPIB, refer to “Programmers Guide.”

### Setting talker/listener GPIB address of E5061A/E5062A

When controlling the E5061A/E5062A using GPIB commands from the external controller connected to the GPIB connector, you need to set the talker/listener GPIB address of the E5061A/E5062A.

Follow these steps to make this setting:

- Step 1.** Press **System**.
- Step 2.** Press **Misc Setup**.
- Step 3.** Press **GPIB Setup**.
- Step 4.** Press **Talker/Listener Address**.
- Step 5.** Enter the address using the ENTRY block keys on the front panel.

### Setting system controller (USB/GPIB interface)

When controlling an external device from the E5061A/E5062A, connect the USB port of the E5061A/E5062A and the GPIB port of the external device through the USB/GPIB interface.

Follow these steps to set the USB/GPIB interface:

- Step 1.** Connect the USB port of the E5061A/E5062A to the USB/GPIB interface. The USB/GPIB Interface Detected dialog box (Figure 10-1) appears.

**NOTE** Do not connect two or more USB/GPIB interfaces.

**Figure 10-1** USB/GPIB Interface Detected dialog box

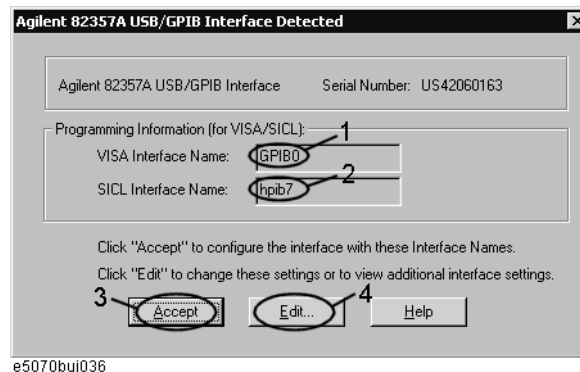

- Step 2.** Confirm that VISA Interface Name is set to GPIB0 (1 in Figure 10-1) and SICL Interface

Name is set to hpi7 (2 in Figure 10-1) and then click the **Accept** button (3 in Figure 10-1). If the setting is correct, the procedure is complete. If the setting is different, click the **Edit** button (4 in Figure 10-1).

- Step 3.** The USB to GPIB Configuration dialog box (Figure 10-2) appears. Make the setting enclosed in the thick lines in Figure 10-2 (1 in Figure 10-2) according to the figure and then click the **OK** button (2 in Figure 10-2).

Figure 10-2

USB to GPIB Configuration dialog box

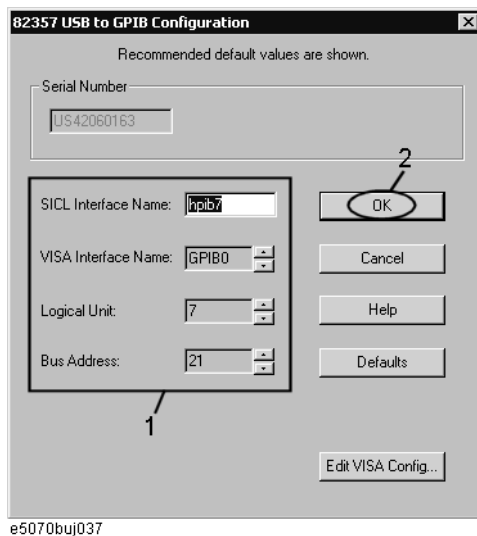

If you need to check/change the setting of the USB/GPIB interface after connecting the USB/GPIB interface, follow these steps:

- Step 1.** Press **System**.
- Step 2.** Press **Misc Setup**.
- Step 3.** Press **GPIB Setup**.
- Step 4.** Press **System Controller Configuration**.
- Step 5.** The IO Config dialog box (Figure 10-3) appears. Select (highlight) **GPIB0 hpi7** (1 in Figure 10-3) and then click the **Edit** button (2 in Figure 10-3).

**NOTE**

In the IO Config dialog box, do not click buttons other than specified here or do not change other settings because doing so may cause serious damage to the functions of the E5061A/E5062A.

Figure 10-3

IO Config dialog box

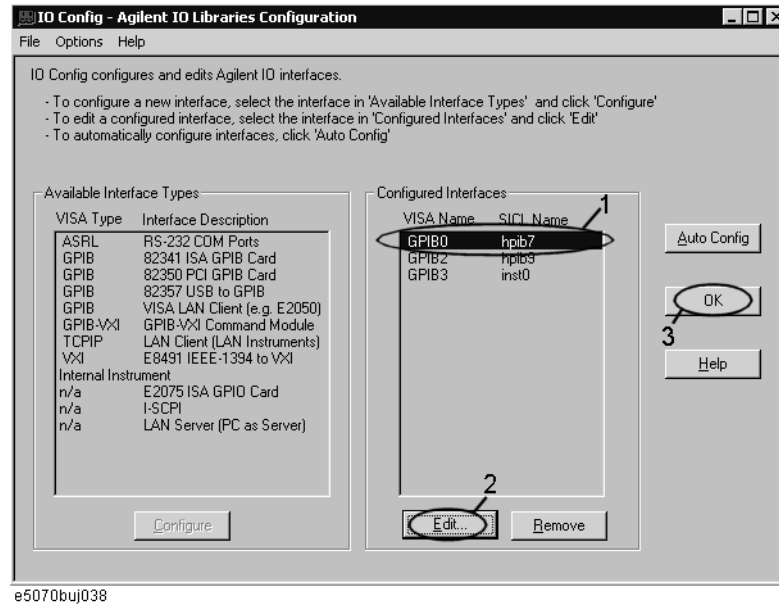

**Step 6.** The USB to GPIB Configuration dialog box (Figure 10-2) appears. Check/change the setting of the USB/GPIB interface and then click the **OK** button (2 in Figure 10-2).

**Step 7.** In the USB to GPIB Configuration dialog box, click the **OK** button (3 in Figure 10-3).

## Setting the Internal Clock

The E5061A/E5062A has the built-in clock that keeps track of the date and time. This clock is used for the following functions.

- To display the current date and time in the instrument status bar at the lower part of the screen
- To write date and time information when saving internal data or a VBA program

## Setting the Date and Time

**Step 1.** Press **System**.

**Step 2.** Press **Misc Setup**.

**Step 3.** Press **Clock Setup**.

**Step 4.** Press **Set Date and Time**.

The dialog box in Figure 10-4 appears.

Figure 10-4

Date/Time Properties Dialog Box (“Date & Time” Tab)

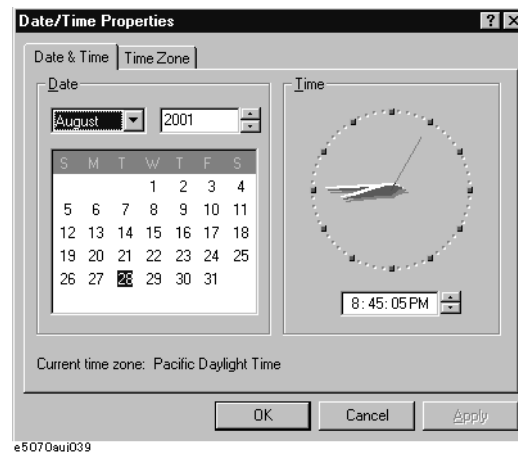

**Step 5.** Set the date in the **Date** area, and set the time in the **Time** area.

**Step 6.** Press the **Time Zone** tab.

The dialog box in Figure 10-5 appears.

**Figure 10-5**

**Date/Time Properties Dialog Box (“Time Zone” Tab)**

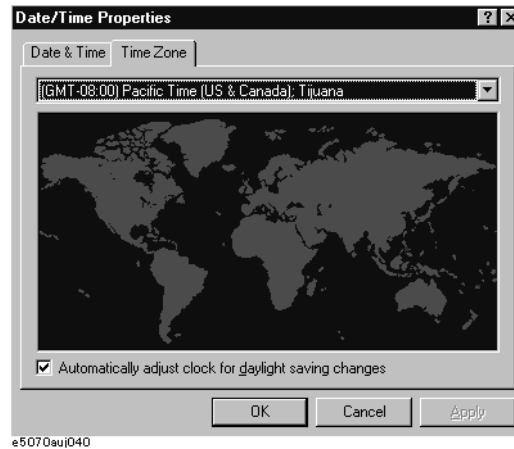

**Step 7.** In the drop-down list box select a time zone.

**Step 8.** To make the summertime setting automatically, check **Automatically adjust clock for daylight saving changes** to assign the check mark (✓) to it.

**Step 9.** Press the **OK** button.

### **Setting the Date/Time Display ON/OFF**

The date/time display in the instrument status bar can be switched on/off using the following procedure.

**Step 1.** Press **System**.

**Step 2.** Press **Misc Setup**.

**Step 3.** Press **Clock Setup**.

**Step 4.** Press **Show Clock** to switch the date/time display on/off.

## Setting the Mouse

The user can change the setup for the mouse connected to the E5061A/E5062A and the movement of the pointer.

### Setup Step

**NOTE** Be sure to use a mouse and a keyboard for mouse setup operations.

**Step 1.** Press **System**.

**Step 2.** Press **Misc Setup**.

**Step 3.** Press **Control Panel** to open the Control Panel window.

**Figure 10-6** Control Panel Window

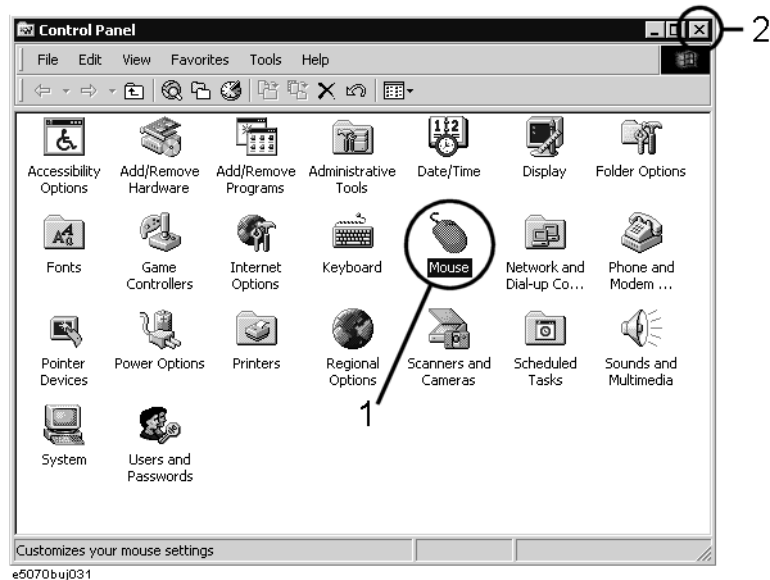

**Step 4.** Double-click the **Mouse** icon (1 in Figure 10-6) in the Control Panel window.

**NOTE** Do not click icons other than specified here or do not change other settings because doing so may cause serious damage to the functions of the E5061A/E5062A.

## Setting and Using the Control and Management Functions

### Setting the Mouse

**Step 5.** The Mouse Properties dialog box (Figure 10-7) is displayed.

Define the setup for a right-handed/left-handed person in the **Buttons configuration** area. Define also the setup for double-click speed in the **Double-click speed** area.

**Figure 10-7** Mouse Properties Dialog Box (Buttons tab)

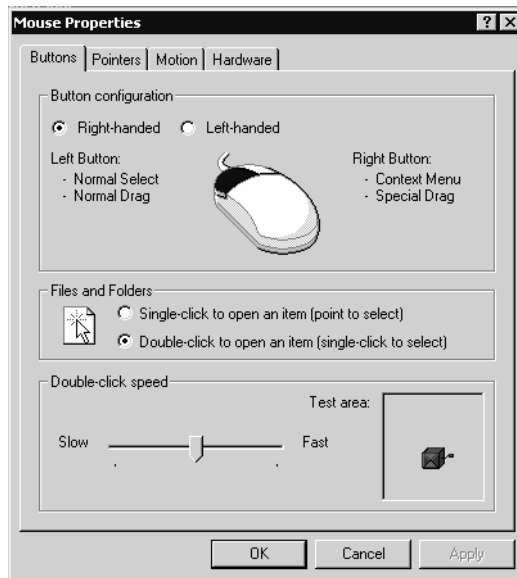

e5070buj028

**Step 6.** Click the **Pointers** tab (Figure 10-8).

**Figure 10-8** Mouse Properties Dialog Box (Pointers tab)

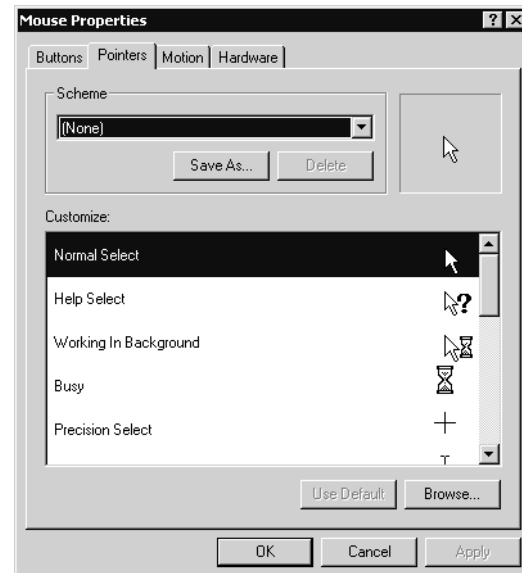

e5070buj029



**Step 7.** Enter a registration name into the **Scheme** box and specify the shapes of pointers for the registration name in the box below.

To create a registration name, click the **Save As...** button. Enter the registration name into the **Save Scheme** dialog box that appears, and click the **OK** button.

**Step 8.** Click the **Motion** tab (Figure 10-9).

**Figure 10-9** Mouse Properties Dialog Box (Motion tab)

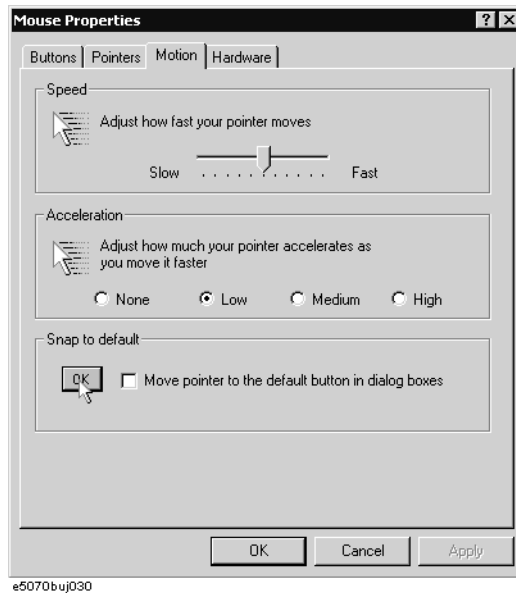

**Step 9.** Specify the pointer speed in the **Pointer speed** area and the pointer trail in the **Pointer trail** area.

**Step 10.** Click the **OK** button.

**Step 11.** Click the × button (1 in Figure 10-6) at the corner in the Control Panel window.

---

## Configuring the Network

---

### NOTE

When you use the E5061A/E5062A by connecting it to your LAN, consult your network administrator and make the setting of the LAN correctly.

This section describes how to set the following basic items necessary to connect the E5061A/E5062A to the LAN (Local Area Network).

- ❑ “Enabling/disabling network” on page 220
- ❑ “Setting IP address” on page 221
- ❑ “Specifying computer name” on page 223

If you need detail network settings, consult your network administrator and perform operation in the same way as the Windows 2000® PC.

### Enabling/disabling network

You can enable/disable the network connection function of the E5061A/E5062A.

Follow these steps to enable/disable the network connection function.

- Step 1.** Use the LAN cable to connect the E5061A/E5062A to the LAN.
- Step 2.** Press **System**.
- Step 3.** Press **Misc Setup**.
- Step 4.** Press **Network Setup**.
- Step 5.** Press **Network Configuration** to open the Network and Dial-up Connections window (Figure 10-10).

**Figure 10-10** Network and Dial-up Connections window

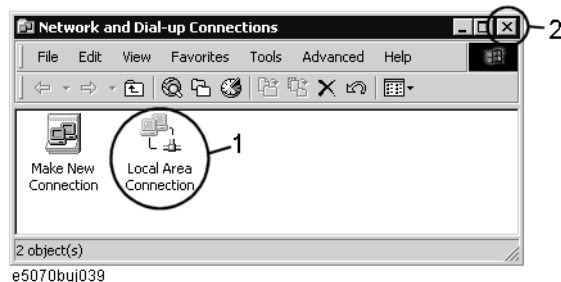

**Step 6. When switching from disable to enable:**

Double-click the Local Area Connection icon (1 in Figure 10-10) in the Network and Dial-up connections window to enable the network connection function.

**When switching from enable to disable:**

Double-click the Local Area Connection icon (1 in Figure 10-10) in the Network and Dial-up Connections window. The Local Area Connection Status dialog box (Figure 10-11) appears. Click the **Disable** button (1 in Figure 10-11) to disable the network connection function.

**Figure 10-11** Local Area Connection Status dialog box

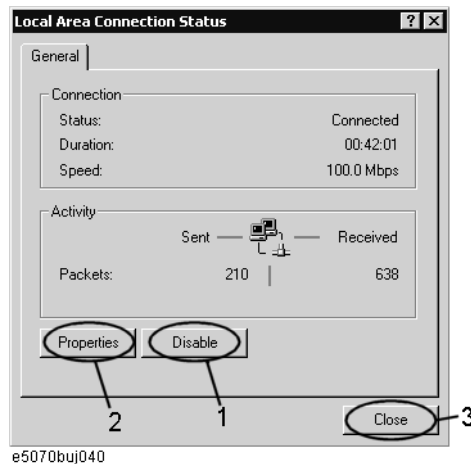

**Step 7.** Click the × button (2 in Figure 10-10) in the upper right of the Network and Dial-up Connections window.

### Setting IP address

Follow these steps to set the IP address:

- Step 1.** Press **[System]**.
- Step 2.** Press **Misc Setup**.
- Step 3.** Press **Network Setup**.
- Step 4.** Press **Network Configuration**.
- Step 5.** Double-click the Local Area Connection icon (1 in Figure 10-10) in the Network and Dial-up Connections window. The Local Area Connection Status dialog box (Figure 10-11) appears. Click the **Properties** button (2 in Figure 10-11).

## Setting and Using the Control and Management Functions Configuring the Network

**Step 6.** The Local Area Connection Properties dialog box (Figure 10-12) appears. Select (highlight) **Internet Protocol (TCP/IP)** (1 in Figure 10-12) and then click the **Properties** button (2 in Figure 10-12).

**Figure 10-12** Local Area Connection Properties dialog box

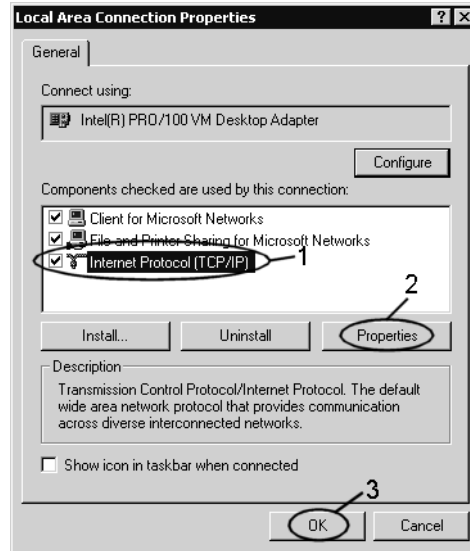

**Step 7.** The Internet Protocol (TCP/IP) Properties dialog box (Figure 10-13) appears. Click (select) **Use the following IP address** (1 in Figure 10-13) and then enter the IP address (2 in Figure 10-13), the subnet mask (3 in Figure 10-13), and the gateway address (4 in Figure 10-13).

If the IP address can be obtained automatically (if the DHCP server can be used), click (select) **Obtain an IP address automatically** (5 in Figure 10-13).

**Figure 10-13** Internet Protocol (TCP/IP) Properties dialog box

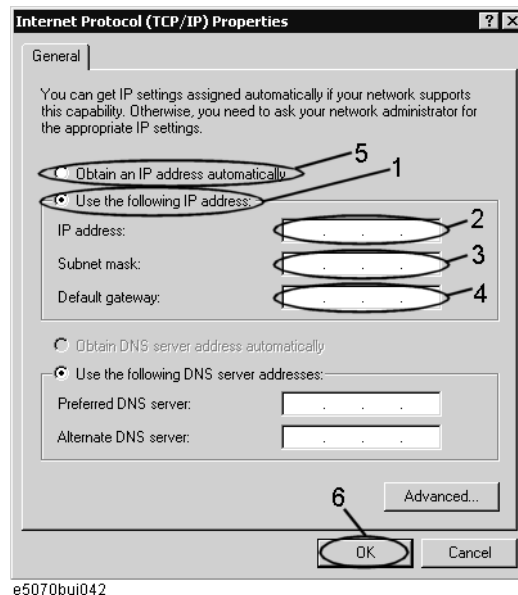

- Step 8.** In the Internet Protocol (TCP/IP) Properties dialog box, click the **OK** button (6 in Figure 10-13).
- Step 9.** In the Local Area Connection Properties dialog box, click the **OK** button (3 in Figure 10-12).
- Step 10.** In the Local Area Connection Status dialog box, click the **Close** button (3 in Figure 10-11).
- Step 11.** Click the × button (2 in Figure 10-10) in the upper right of the Network and Dial-up Connections window.

### Specifying computer name

Follow these steps to specify the computer name:

- Step 1.** Press **System**.
- Step 2.** Press **Misc Setup**.
- Step 3.** Press **Network Setup**.
- Step 4.** Press **Network Identification**.
- Step 5.** The System Properties dialog box (Figure 10-14) appears. Click the **Properties** button (1 in Figure 10-14).

Figure 10-14

System Properties dialog box

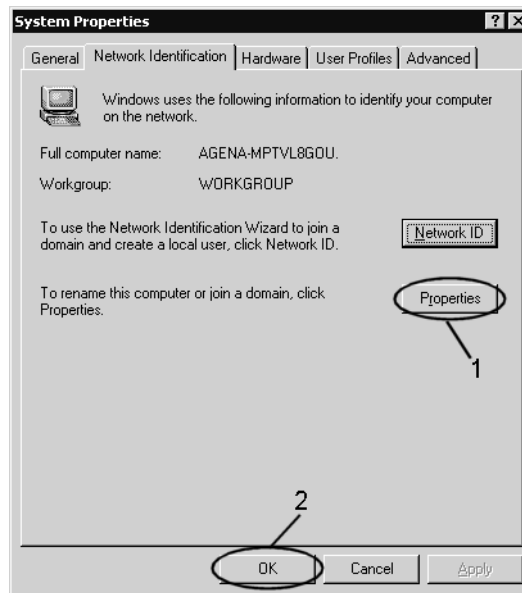

e5070buj043

## Setting and Using the Control and Management Functions Configuring the Network

- Step 6.** The Identification Changes dialog box (Figure 10-15) appears. Enter the computer name in the **Computer Name** box (1 in Figure 10-15).

**Figure 10-15** Identification Changes dialog box

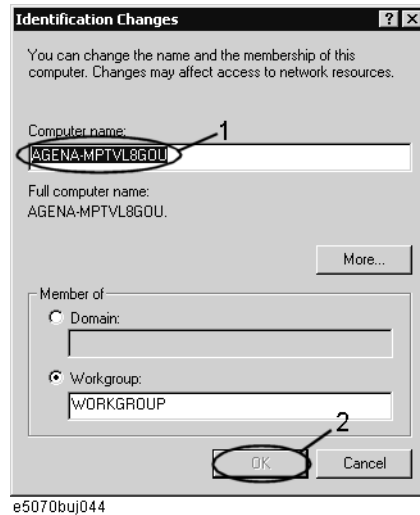

- Step 7.** The Network Identification dialog box (Figure 10-16) appears. Click the **OK** button.

**Figure 10-16** Network Identification dialog box

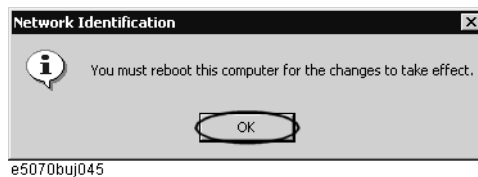

- Step 8.** In the Identification Changes dialog box, click the **OK** button (2 in Figure 10-15).

- Step 9.** In the System Properties dialog box, click the **OK** button (2 in Figure 10-14).

- Step 10.** The System Settings Change dialog box (Figure 10-17) appears. Click the **Yes** button to restart the E5061A/E5062A.

**Figure 10-17** System Settings Change dialog box

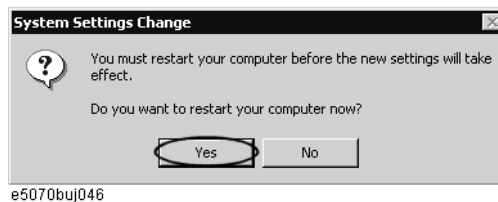

### NOTE

Until the E5061A/E5062A is restarted, changed setting does not take effect.

---

## Remote Control Using HTTP

You can access the web page installed in the E5061A/E5062A by using the hypertext transfer protocol (http) and the E5061A/E5062A's IP address from the external PC's web browser. Through the built-in web page, you can control the E5061A/E5062A remotely and display the measurement screen on external PCs.

---

### NOTE

This function is available when the volume label on the hard disk is AL200 or higher.

The following browsers are recommended:

- Java Script enabled browser
- Internet Explorer 5
- Netscape 4.7

The following information will help you to remotely control the E5061A/E5062A via the built-in web page.

## Required Modification of Settings

### Network

Configure the E5061A/E5062A's network correctly. For detailed information on configuration and notes, see “Configuring the Network” on page 220.

### Enabling Web Server

Enable the web server for the E5061A/E5062A so that it may allow access from an external PC. Follow these steps:

- Step 1.** Press **[System]**.
- Step 2.** Press **Misc Setup - Network Setup**.
- Step 3.** Press **Web Server** to turn it on. The default is OFF.

---

### NOTE

This function is available only when the Internet Information Services (IIS) is installed in the E5061A/E5062A. The web server softkey is not displayed if the IIS is not installed.

---

### NOTE

The external PC must have the Java™ Runtime Environment installed.

## How to Start VNC Server Configuration

To restrict external access, set a password for the VNC server configuration.

The following is a description of how to start the VNC server configuration. Visit the web site at <http://www.realvnc.com> for information on the password setting procedure and VNC server.

- Step 1.** Press **[System]**.

Setting and Using the Control and Management Functions  
**Remote Control Using HTTP**

**Step 2.** Press **Misc Setup - Network Setup**.

**Step 3.** Press **VNC Server Configuration** to start the VNC Server Properties.



## Accessing Hard Disk of E5061A/E5062A from External PC

If you connect the E5061A/E5062A to LAN, you can access the hard disk (D drive) in the E5061A/E5062A as a network drive from an external PC connected to the same LAN.

### NOTE

See “Connecting Hard Disk (Shared Folder) of External PC” of Chapter 6, “Application Programs” in *VBA Programmer’s Guide* for information on accessing the hard disk of the external PC connected to the same LAN from the E5061A/E5062A.

Figure 10-18

Accessing to drive D of E5061A/E5062A from external PC

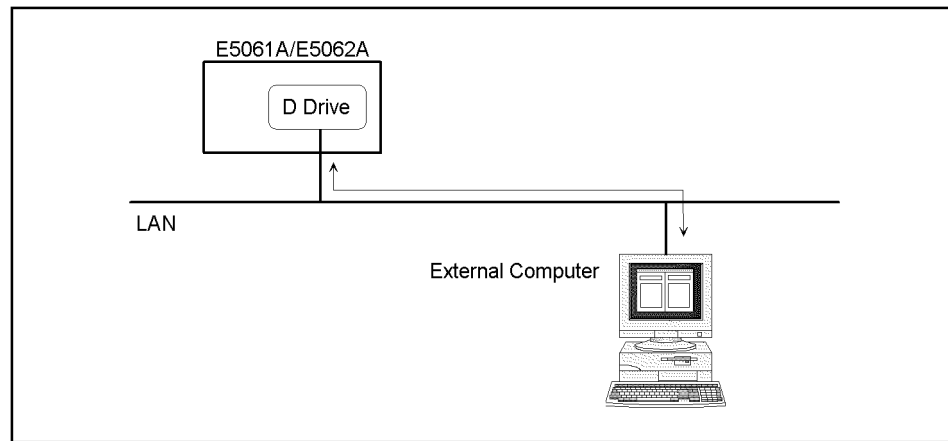

e5061aue014

## Enabling the access form the external PC

This section shows the simplest procedure to enable the access from the external PC.

### NOTE

It is recommended that you use setting with higher security consulting your network administrator.

- Step 1.** Press .
- Step 2.** Press **Explorer...**
- Step 3.** The Windows Explorer (refer to Figure 7-6 on page 170) opens. Select (highlight) **USER (D:)** and then click **Properties** in the File menu.

**Step 4.** The USERS(D:) Properties dialog box (Figure 10-19) appears. Select the **Sharing** tab.

**Figure 10-19** USERS(D:) Properties dialog box (General tab)

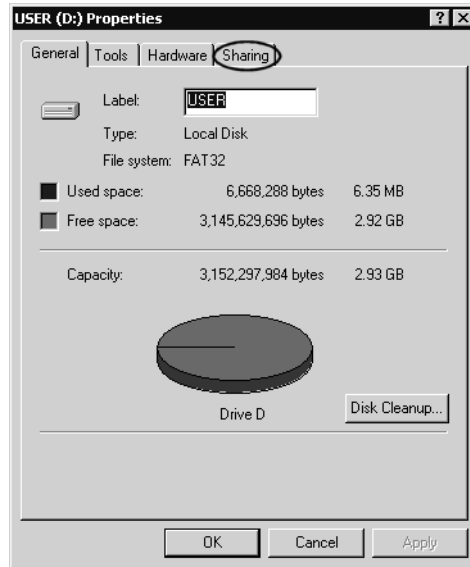

e5070buj047

**Step 5.** Click the **New Share** button (1 in Figure 10-20).

**Figure 10-20** USERS(D:) Properties dialog box (Sharing tab)

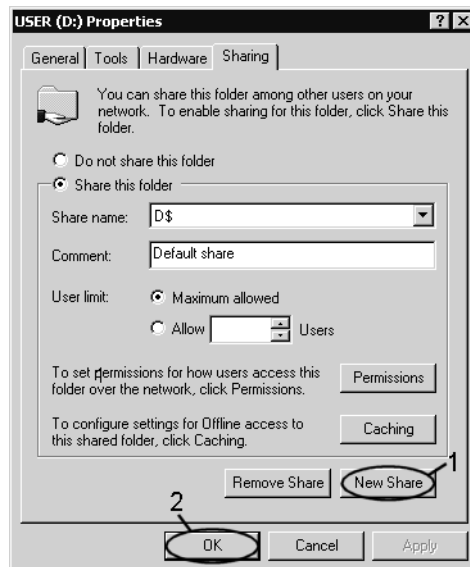

e5070buj048

- Step 6.** The New Share dialog box (Figure 10-21) appears. Enter the share name (name used when accessed from the external PC) in the **Share Name** box (1 in Figure 10-21) and click the **OK** button (2 in Figure 10-21).

**Figure 10-21**

**New Share dialog box**



- Step 7.** In the USERS(D:) Properties dialog box, click the **OK** button (2 in Figure 10-20).

### Accessing hard disk of E5061A/E5062A from external PC

This section describes the procedure to connect to the hard disk (D drive) in the E5061A/E5062A to which access has been made possible according to the procedure described in “Enabling the access form the external PC” on page 227 from the external PC, taking Windows NT ® as an example.

#### **NOTE**

For information on connection, see your PC's operation manual.

- Step 1.** From the Start menu, click Programs - Windows Explorer to start the Explorer.
- Step 2.** From the Explorer's menu, click **Tools - Map Network Drive...**
- Step 3.** The Map Network Drive dialog box appears. Select an appropriate drive, enter **\\C\_NAME\S\_NAME** as the network path and then click the **OK** button.
- C\_NAME** in the network path is the computer name of the E5061A/E5062A and **S\_NAME** is the share name of the D drive. For information on how to set the computer name, refer to “Specifying computer name” on page 223; for information on how to set the share name, refer to “Enabling the access form the external PC” on page 227.
- Step 4.** The dialog box to enter the user name and the password appears. Enter an appropriate user name and password and then click the **OK** button.

The user name and password differ depending on the setting made when enabling access from the external PC. When you have set them according to “Enabling the access form the external PC” on page 227, you can make connection using the user name, **agena**, without the password.

## **Locking the Front Keys, Keyboard, and/or Mouse (Touch Screen)**

You can lock (disable) the front keys, keyboard, and/or mouse (touch screen). This feature prevents erroneous operation caused by inadvertently touching any of these devices.

### **Locking the Front Keys, Keyboard, and/or Mouse**

- Step 1.** Press **System**.
- Step 2.** Press **Misc Setup**.
- Step 3.** Press **Key Lock**.
- Step 4.** Press the corresponding key to switch the lock on/off.

| <b>Softkey</b>                         | <b>Function</b>   |
|--|---|
| <b>Front Panel &amp; Keyboard Lock</b> | Switches the lock for the front panel keys and keyboard on/off. |
| <b>Touch Screen &amp; Mouse Lock</b>   | Switches the lock for the touch screen and mouse on/off.        |

---

#### **NOTE**

You cannot use a locked device to unlock that same device. To unlock the front panel keys, keyboard, touch screen and mouse that have been locked, press the Standby switch to turn off the power supply and then turn it on again. When setting at power-on, the front panel keys, keyboard, touch screen and mouse are all in an unlocked condition.

---

## Setting the Beeper (Built-in Speaker)

The E5061A/E5062A has a built-in speaker that sounds a beep tone. The beeper allows you to make two types of settings shown in Table 10-1.

**Table 10-1**

**Beeper Functions**

| Type                      | Function   |
|---------------------------|--|
| Operation complete beeper | <p>Sounds a beep tone to inform the user that operations have completed.</p> <ul style="list-style-type: none"> <li>• When calibration data measurements are done</li> <li>• When data storage has completed</li> </ul>          |
| Warning beeper            | <p>Sounds a beep tone to prompt the user to use caution.</p> <ul style="list-style-type: none"> <li>• When an instrument error occurs (An error message appears at the same time.)</li> <li>• When a limit test fails</li> </ul> |

The warning beeper sounds slightly longer than the operation complete beeper.

### Setting the Operation Complete Beeper

- Step 1.** Press **System**.
- Step 2.** Press **Misc Setup**.
- Step 3.** Press **Beeper**.
- Step 4.** Press **Beep Complete** to switch the operation complete beeper on/off.

Pressing **Test Beep Complete** allows you to hear and check the beep tone of the operation complete beeper.

### Setting the Warning Beeper

- Step 1.** Press **System**.
- Step 2.** Press **Misc Setup**.
- Step 3.** Press **Beeper**.
- Step 4.** Press **Beep Warning** to switch the warning beeper on/off.

Pressing **Test Beep Warning** allows you to hear and check the beep tone of the warning beeper.

## **Turning off the LCD Screen Backlight**

You can switch off the backlight (illumination) of the LCD screen of the E5061A/E5062A. This extends the life of the backlight when using it continuously over a long period.

### **Turning off the LCD Screen Backlight**

**Step 1.** Press **System**.

**Step 2.** Press **Backlight** to switch the backlight on/off.

Switching off the backlight causes indications on the LCD screen to be almost invisible.

The backlight that has been switched off can be turned on again by pressing **Preset**. When the LCD backlight is off, **Preset** works as a key for switching the backlight back on.

## Checking the product information

### Checking the serial number

The revision number of the firmware installed in the E5061A/E5062A can be checked using the following procedure.

#### Checking the serial number

- Step 1.** Press **System**.
- Step 2.** Press **Service Functions**.
- Step 3.** Press **Enable Options**.

The serial number is displayed in the softkey menu bar.

### Checking the Firmware Revision

The revision number of the firmware installed in the E5061A/E5062A can be checked using the following procedure.

#### Checking the Firmware Revision

- Step 1.** Press **System**.
- Step 2.** Press **Firmware Revision**.  
The Firmware Revision dialog box appears.
- Step 3.** Press **OK** to close the dialog box.

## Setting the preset function

### Showing/hiding the confirmation buttons when presetting

The preset function can be executed without displaying the **OK** and **Cancel** softkey buttons when pressing the preset button of the E5061A/E5062A.

#### Operational procedure

- Step 1.** Press **System**.
- Step 2.** Press **Misc Setup**.
- Step 3.** Press **Preset Setup**.
- Step 4.** **Confirm** to toggle on (show)/off (hide) the confirmation buttons.

### Setting the user preset function

You can save the instrument state of the E5061A/E5062A into a file in the mass storage, and then recall it with the preset function to reproduce that state.

If no user preset instrument state is stored, you cannot set the user preset function. For more information on saving instrument states, see “Saving a user-preset instrument state” on page 235.

#### Operational procedure

- Step 1.** Press **System**.
- Step 2.** Press **Misc Setup**.
- Step 3.** Press **Preset Setup**.
- Step 4.** Press **State**.
- Step 5.** Use one of the following keys for the desired setting.

| Softkey[       | Function   |
|----------------|--|
| <b>Factory</b> | Specifies the normal preset function.              |
| <b>User</b>    | Specifies the user-preset function.                |
| <b>Cancel</b>  | Returns to the softkey display in one upper level. |



## Saving a user-preset instrument state

To execute the user-preset function, you must have a preset setting file that has been saved. Follow these steps to save a preset instrument state of the E5061A/E5062A.

### Operational procedure

- Step 1.** Sets up a preset instrument state you want to save.
- Step 2.** Press .
- Step 3.** Press **Save State**.
- Step 4.** Pressing **User Preset** saves the instrument state.

## System Recovery

By executing system recovery, you can return the system of the E5061A/E5062A (the Windows operating system and the firmware) to the factory state (at the time of purchase <sup>\*1</sup>).

### Types of system recoveries

The following two types of system recoveries are available.

Factory recovery

Returns the contents of the C drive to the factory state.

User recovery<sup>\*2</sup>

Returns the contents of the C drive to a user-specified state. To use this function, you must prepare for recovery in advance. For information on preparation, see “Procedure to create the user backup image” on page 240 for information on the execution. Also, see “Procedure to execute the user recovery function” on page 243.

### Notes on executing the factory recovery function

Executing the factory recovery function causes the following:

- In addition to the Windows operating system and the firmware, the following settings of the E5061A/E5062A are returned to the factory state or a user specified state.
  - Network setting
  - GPIB setting
  - Printer setting
- The driver for the supported printer installed after purchase is deleted.
- You need to execute initial registration again.

Files you created using the save function (files in the D drive) are not affected, but we recommend backing them up before executing system recovery for precautionary purposes. For more information on backup, refer to “Making Backup Files” on page 286.

---

\*1. If the hard disk failed and has been replaced after purchase, the state when the replacement was performed is recovered.

\*2. This function is available when the volume label on the hard disk is AL200 or higher.

## Procedure to execute the factory recovery function

This section describes how to return the contents of the C drive to the factory state.

---

**NOTE** You need the keyboard for this operation.

---

- Step 1.** Shut down the E5061A/E5062A.
- Step 2.** Connect the keyboard to the E5061A/E5062A.
- Step 3.** Insert the disk for the system recovery into the floppy disk drive of the E5061A/E5062A.
- Step 4.** Press the standby switch of the E5061A/E5062A to turn it on.
- Step 5.** When the screen as shown in the figure below appears, press and hold **Esc** of the keyboard until this screen disappears.

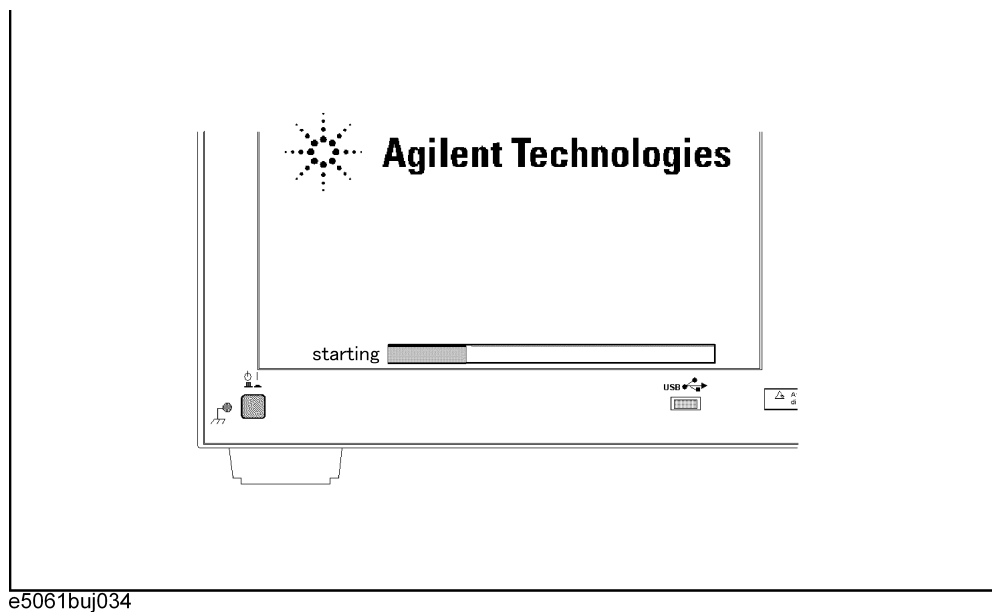

---

**NOTE** After several seconds, the next screen appears automatically even if you do not press any key, so do not miss it.

If the above message does not appear, the instrument is at fault; contact your local Agilent customer center listed at the end of this manual or distributor.

---

## Setting and Using the Control and Management Functions

### System Recovery

**Step 6.** The following screen appears. Check that Floppy is selected (highlighted) (if Floppy is not selected, select it with  of the keyboard), and press  of the keyboard.

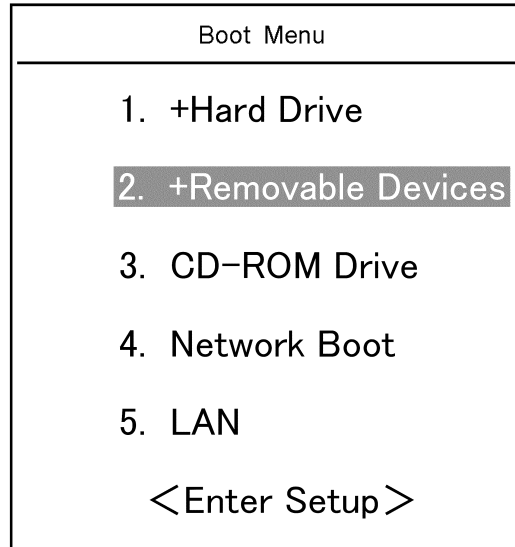

**Step 7.** The message as shown below appears. Press  of the keyboard. If you want to cancel the factory recovery, press  here.

Agilent Technologies System Utilities  
Recovery & Backup Options for the E5061/62A

Choose One of the following:

- 
1. Recover Factory Backup Image
  2. Create User Backup Image
  3. Recover User Backup Image
  4. Exit
- 

Enter a Choice: \_

---

#### NOTE

If the above message does not appear, the instrument or the disk for the system recovery is at fault; contact your local Agilent customer center listed at the end of this manual or distributor.

- Step 8.** The message as shown below appears. Press **C** of the keyboard. If you want to cancel the factory recovery, press **E** here.

You chose to Restore your system by installing the original factory installed OS and system software.

WARNING: Press C to Continue only if you are sure that you want to proceed. The C: Drive will be completely overwritten with no chance of recovering any data. Use Option 1 to recover the system from a serious malfunction caused by corrupted or inadvertently deleted files on the system's primary C: partition.

Press C to Continue or E to Exit: \_

- Step 9.** The message as shown below appears. Press **C** of the keyboard to start the factory recovery. If you want to cancel the factory recovery, press **E** here.

CAUTION! Interrupting this process may leave the system in an unstable state. Allow the software to complete the backup and recovery process. This may take up to 20 minutes depending on the system configuration.

Press C to Continue or E to Exit: \_

---

**CAUTION**

**Never turn off the power during the factory recovery because doing so may cause serious damage to the E5061A/E5062A.**

---

- Step 10.** The factory recovery will be complete in about 5 minutes. When the factory recovery is complete, the message as shown below appears. Press **Ctrl**, **Alt**, and **Delete** of the keyboard at the same time to restart.

Remove the disk and Press CLT+ALT+DEL to restart your system.

---

**NOTE**

If the above message does not appear, the instrument is at fault; contact your local Agilent customer center listed at the end of this manual or distributor.

---

- Step 11.** After restart, the screen for initial registration appears. Execute initial registration. For information on the execution procedure, refer to *Installation/Quick Start Guide*.
- Step 12.** For the E5061A/E5062A equipped with the Option 016 touch screen, execute the calibration of the touch screen. For information on the execution procedure, refer to "Calibration of the Touch Screen" on page 246.

### Procedure to create the user backup image

This section describes how to create the user backup image. The C drive contents saved in this creation are recalled when the user recovery function is executed.

---

**NOTE** This function is available when the volume label on the hard disk is AL200 or higher.

---

**NOTE** You need the keyboard for this operation.

---

- Step 1.** Shut down the E5061A/E5062A.
- Step 2.** Connect the keyboard to the E5061A/E5062A.
- Step 3.** Insert the disk for the system recovery into the floppy disk drive of the E5061A/E5062A.
- Step 4.** Press the standby switch of the E5061A/E5062A to turn it on.
- Step 5.** When the screen as shown in the figure below appears, press and hold  of the keyboard until this screen disappears.

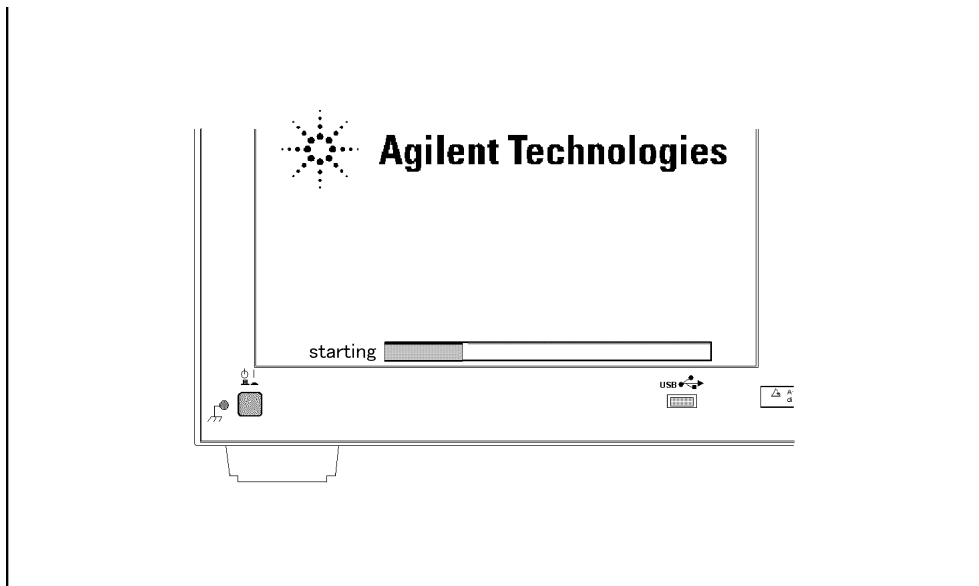

e5061buj034

---

**NOTE** After several seconds, the next screen appears automatically even if you do not press any key, so do not miss it.

If the above message does not appear, the instrument is at fault; contact your local Agilent customer center listed at the end of this manual or distributor.

---

**Step 6.** The following screen appears. Check that Floppy is selected (highlighted) (if Floppy is not selected, select it with **F1** of the keyboard), and press **Enter** of the keyboard.

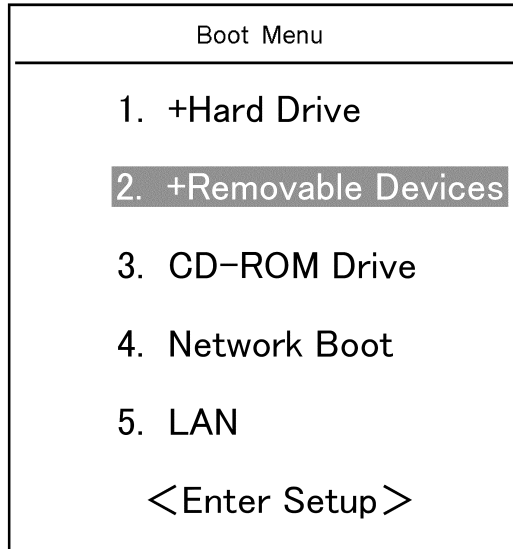

---

**Step 7.** The message as shown below appears. Press **F2** of the keyboard. If you want to cancel the create user backup image, press **F4** here.

Agilent Technologies System Utilities  
Recovery & Backup Options for the E5061/62A

Choose One of the following:

- 
1. Recover Factory Backup Image
  2. Create User Backup Image
  3. Recover User Backup Image
  4. Exit
- 

Enter a Choice: \_

**NOTE**

If the above message does not appear, the instrument or the disk for the system recovery is at fault; contact your local Agilent customer center listed at the end of this manual or distributor.

## Setting and Using the Control and Management Functions

### System Recovery

- Step 8.** The message as shown below appears. Press **C** of the keyboard. If you want to cancel the create user backup image, press **E** here.

You chose to create a backup image file of your system.

The system will perform a quick integrity check of the file structure on the C: Drive. It will then copy the C: partition to an image file and store it on the System Recovery partition.

Press C to Continue or E to Exit: \_

- Step 9.** The message as shown below appears. Press **C** of the keyboard to start the create user backup image. If you want to cancel the create user backup image, press **E** here.

CAUTION! Interrupting this process may leave the system in an unstable state. Allow the software to complete the backup and recovery process. This may take up to 20 minutes depending on the system configuration.

Press C to Continue or E to Exit: \_

---

#### CAUTION

**Never turn off the power during the create user backup image because doing so may cause serious damage to the E5061A/E5062A.**

---

- Step 10.** The create user backup image will be complete in about 5 minutes. When the create user backup image is complete, the message as shown below appears. Press **Ctrl**, **Alt**, and **Delete** of the keyboard at the same time to restart.

Remove the disk and Press CLT+ALT+DEL to restart your system.

---

#### NOTE

If the above message does not appear, the instrument is at fault; contact your local Agilent customer center listed at the end of this manual or distributor.

---



### Procedure to execute the user recovery function

Returns the contents of the C drive to a user-specified state. To use this function, you must create the user backup image in advance. For more information, see the description “Procedure to create the user backup image” on page 240.

---

**NOTE** This function is available when the volume label on the hard disk is AL200 or higher.

---

**NOTE** You need the keyboard for this operation.

---

- Step 1.** Shut down the E5061A/E5062A.
- Step 2.** Connect the keyboard to the E5061A/E5062A.
- Step 3.** Insert the disk for the system recovery into the floppy disk drive of the E5061A/E5062A.
- Step 4.** Press the standby switch of the E5061A/E5062A to turn it on.
- Step 5.** When the screen as shown in the figure below appears, press and hold  of the keyboard until this screen disappears.

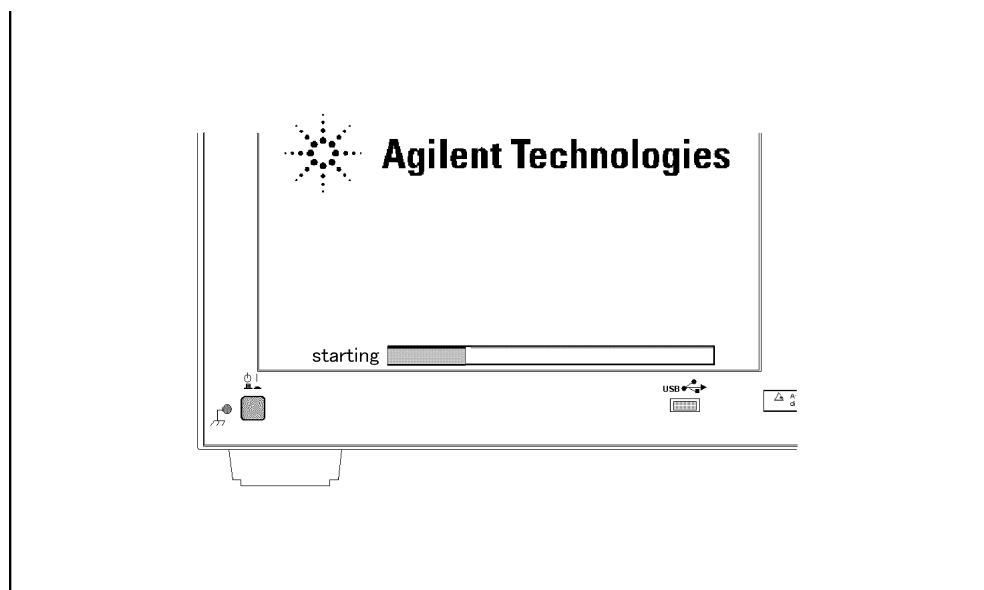

e5061buj034

---

**NOTE** After several seconds, the next screen appears automatically even if you do not press any key, so do not miss it.

If the above message does not appear, the instrument is at fault; contact your local Agilent customer center listed at the end of this manual or distributor.

---

## Setting and Using the Control and Management Functions

### System Recovery

**Step 6.** The following screen appears. Check that Floppy is selected (highlighted) (if Floppy is not selected, select it with  of the keyboard), and press  of the keyboard.

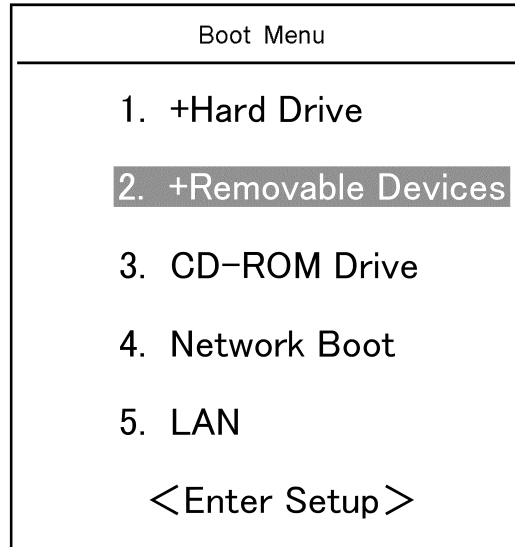

**Step 7.** The message as shown below appears. Press  of the keyboard. If you want to cancel the user recovery, press  here.

Agilent Technologies System Utilities  
Recovery & Backup Options for the E5061/62A

Choose One of the following:

- 
1. Recover Factory Backup Image
  2. Create User Backup Image
  3. Recover User Backup Image
  4. Exit
- 

Enter a Choice: \_

---

#### NOTE

If the above message does not appear, the instrument or the disk for the system recovery is at fault; contact your local Agilent customer center listed at the end of this manual or distributor.

---

- Step 8.** The message as shown below appears. Press **C** of the keyboard. If you want to cancel the user recovery, press **E** here.

You chose to recover your own system backup image file.

WARNING: Press C to Continue only if you are sure that you want to proceed. The C: partition will be completely overwritten with no chance of recovering any data. Use Option 3 to recover the system from a serious malfunction caused by corrupted or inadvertently deleted files on the system's primary C: partition.

Press C to Continue or E to Exit: \_

- Step 9.** The message as shown below appears. Press **C** of the keyboard to start the user recovery. If you want to cancel the user recovery, press **E** here.

CAUTION! Interrupting this process may leave the system in an unstable state. Allow the software to complete the backup and recovery process. This may take up to 20 minutes depending on the system configuration.

Press C to Continue or E to Exit: \_

---

**CAUTION**

**Never turn off the power during the system recovery because doing so may cause serious damage to the E5061A/E5062A.**

---

- Step 10.** The user recovery will be complete in about 5 minutes. When the user recovery is complete, the message as shown below appears. Press **Ctrl**, **Alt**, and **Delete** of the keyboard at the same time to restart.

Remove the disk and Press CLT+ALT+DEL to restart your system.

---

**NOTE**

If the above message does not appear, the instrument is at fault; contact your local Agilent customer center listed at the end of this manual or distributor.

---

---

## Calibration of the Touch Screen

When you have executed system recovery on the E5061A/E5062A equipped with an Option 016 touch screen, you have to calibrate the touch screen. Follow the procedure described below to calibrate the touch screen.

- Step 1.** Press **System**.
- Step 2.** Press **Service Menu**.
- Step 3.** Press **Test Menu**.
- Step 4.** Press **Adjust Touch Screen**.

The touch screen calibration screen (Figure 10-22) appears.

**Figure 10-22**

**Touch Panel Calibration Screen**

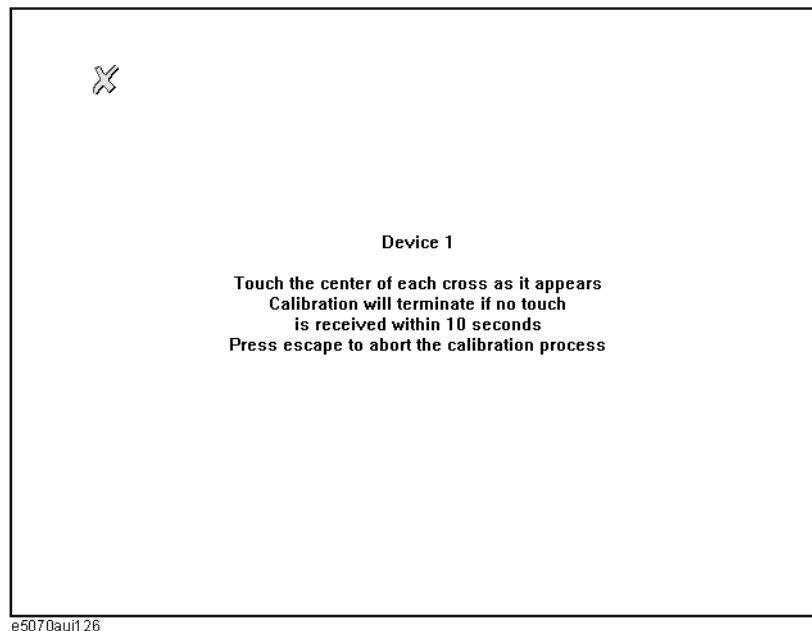

- Step 5.** Touch the x mark on the upper left with your finger. The mark x appears also on the lower left, upper right, and lower right. Touch the x marks in that order with your finger.

Touching the four locations described above with your finger automatically concludes the touch screen calibration.

---

**NOTE**

With no operation on the touch screen calibration screen for a preset time, it automatically closes and the previous measurement screen reappears.

---

# 11 Measurement Examples

This chapter introduces examples of actual device measurements using the Agilent E5061A/E5062A.

## Measuring the SAW Bandpass Filter Using the Segment Sweep

This section illustrates how to use the segment sweep function to evaluate a SAW bandpass filter with a center frequency of 947.5 MHz.

### Evaluation Steps

Here, the DUT is evaluated by following the steps described in Table 11-1.

**Table 11-1 Evaluating the DUT Using the Segment Sweep**

| Step   | Description  |
|--|--|
| <b>“1. Determine the Segment Sweep Conditions” on page 249</b>     | The segment sweep conditions are determined considering the characteristics of the DUT.      |
| <b>“2. Create a Segment Sweep Table” on page 250</b>               | The segment sweep conditions are entered in the E5061A/E5062A.                               |
| <b>“3. Select the Segment Sweep as the Sweep Type” on page 252</b> | The segment sweep is selected as the sweep type.   |
| <b>“4. Execute the Calibration” on page 252</b>                    | A 2-port ECal is performed between the test ports connecting the DUT.                        |
| <b>“5. Connect the DUT” on page 253</b>                            | The DUT is connected.  |
| <b>“6. Execute the Measurement” on page 253</b>                    | A trigger is applied to perform the measurement.   |
| <b>“7. Define the Setup for Display” on page 253</b>               | A choice is made between frequency base and order base as the method of displaying segments. |

### 1. Determine the Segment Sweep Conditions

Figure 11-1 shows the result of evaluating the transmission characteristics of the SAW bandpass filter in the range of 440 MHz to 3 GHz by using the linear sweep.

**Figure 11-1**

**Transmission Characteristics of a SAW Bandpass Filter (440 MHz to 3 GHz, linear sweep)**

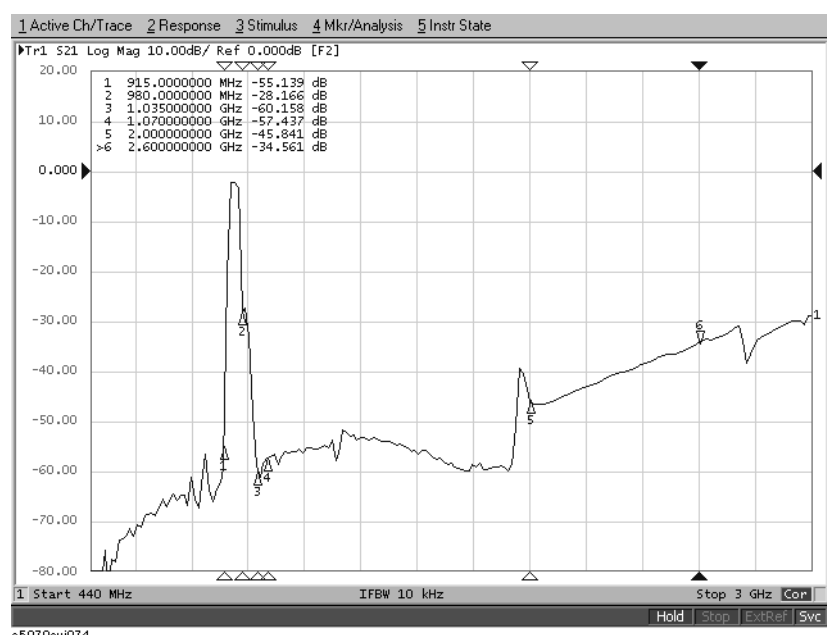

The measurement conditions are determined for each frequency range. Here, the segment sweep is performed following the sweep conditions shown in Table 11-2.

**Table 11-2**

**Determining the Sweep Conditions (Using markers shown in Figure 11-1).**

| Frequency Range        |                         | Measurement Conditions |              |
|------------------------|-------------------------|------------------------|--------------|
| Start                  | Stop                    | Number of Points       | IF Bandwidth |
| 440 MHz                | 915 MHz<br>(Marker 1)   | 47                     | 10 kHz       |
| 915 MHz<br>(Marker 1)  | 980 MHz<br>(Marker 2)   | 130                    | 30 kHz       |
| 980 MHz<br>(Marker 2)  | 1.035 GHz<br>(Marker 3) | 55                     | 10 kHz       |
| 1.07 GHz<br>(Marker 4) | 2 GHz<br>(Marker 5)     | 93                     | 10 kHz       |
| 2.6 GHz<br>(Marker 6)  | 3 GHz                   | 41                     | 10 kHz       |

## 2. Create a Segment Sweep Table

Follow the steps below to make entries in the segment sweep table.

**Step 1.** Display the segment table.

| Setup Description            | Key Operation                                  |
|------------------------------|--|
| Presetting                   | <b>Preset</b> - <b>OK</b>                      |
| Displaying the segment table | <b>Sweep Setup</b> - <b>Edit Segment Table</b> |

**Step 2.** Display the IF bandwidth setting column on the segment table.

| Setup Description                                 | Key Operation                          |
|---|--|
| Moving the focus to the softkey menu              | <b>Focus</b>                           |
| Display of the IF bandwidth setting column:<br>ON | <b>List IFBW</b> (Turn it <b>ON</b> .) |

### NOTE

When setup items (power level, delay time, sweep mode, and sweep time in this case) are not displayed in the segment table, the setting for the channel in use applies to all segments.

**Step 3.** Enter the setup data into the segment table.

| Setup Description                     | Key Operation   |
|---------------------------------------|---|
| Moving the focus to the segment table | <b>Focus</b>  |
| Segment 1                             |   |
| Start frequency: 440 MHz              | <b>4</b> <b>4</b> <b>0</b> <b>M/μ</b>                   |
| Stop frequency: 915 MHz               | <b>9</b> <b>1</b> <b>5</b> <b>M/μ</b>                   |
| Number of points: 47                  | <b>4</b> <b>7</b> <b>x1</b>                             |
| IF bandwidth: 10 kHz                  | <b>1</b> <b>0</b> <b>k/m</b>                            |
| Segment 2                             |   |
| Start frequency: 915 MHz              | <b>9</b> <b>1</b> <b>5</b> <b>M/μ</b>                   |
| Stop frequency: 980 MHz               | <b>9</b> <b>8</b> <b>0</b> <b>M/μ</b>                   |
| Number of points: 130                 | <b>1</b> <b>3</b> <b>0</b> <b>x1</b>                    |
| IF bandwidth: 30 kHz                  | <b>3</b> <b>0</b> <b>k/m</b>                            |
| Segment 3                             |   |
| Start frequency: 980 MHz              | <b>9</b> <b>8</b> <b>0</b> <b>M/μ</b>                   |
| Stop frequency: 1.035 GHz             | <b>1</b> <b>.</b> <b>0</b> <b>3</b> <b>5</b> <b>G/n</b> |



## Measurement Examples

### Measuring the SAW Bandpass Filter Using the Segment Sweep

#### Setup Description

Number of points: 55

IF bandwidth: 10 kHz

#### Segment 4

Start frequency: 1.07 GHz

Stop frequency: 2 GHz

Number of points: 93

IF bandwidth: 10 kHz

#### Segment 5

Start frequency: 2.6 GHz

Stop frequency: 3 GHz

Number of points: 41

IF bandwidth: 10 kHz

#### Key Operation

5 5 x1

1 0 k/m

1 . 0 7 G/n

2 G/n

9 3 x1

1 0 k/m

2 . 6 G/n

3 G/n

4 1 x1

1 0 k/m

Figure 11-2

#### Completed Segment Table

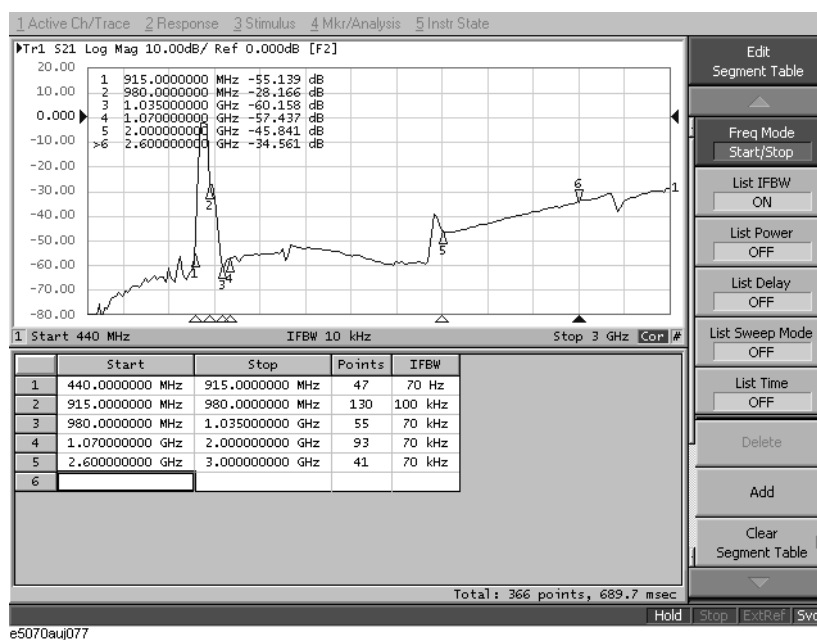

### 3. Select the Segment Sweep as the Sweep Type

The segment sweep is selected as the sweep type.

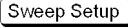
| Setup Description         | Key Operation   |
|---------------------------|---|
| Sweep type: Segment sweep |  - Sweep Type - Segment |

### 4. Execute the Calibration

In this step, a 2-port ECal is executed on the two ports to be used.

**Step 1.** Connect the ECal module across test ports 1 and 2.

**Figure 11-3** Connecting the ECal Module

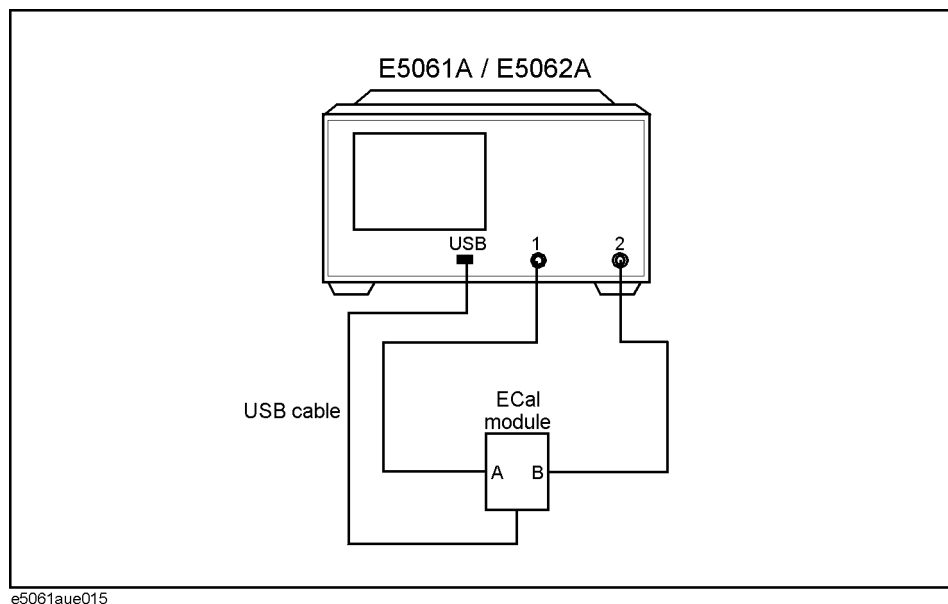

**Step 2.** Execute the 2-port ECal.

| Setup Description                                  | Key Operation  |
|--|--|
| Executing a 2-port ECal between test ports 1 and 2 |  - ECal - 2 Port ECal |

### 5. Connect the DUT

The DUT is connected across test ports 1 and 2.

Figure 11-4

Connecting the DUT

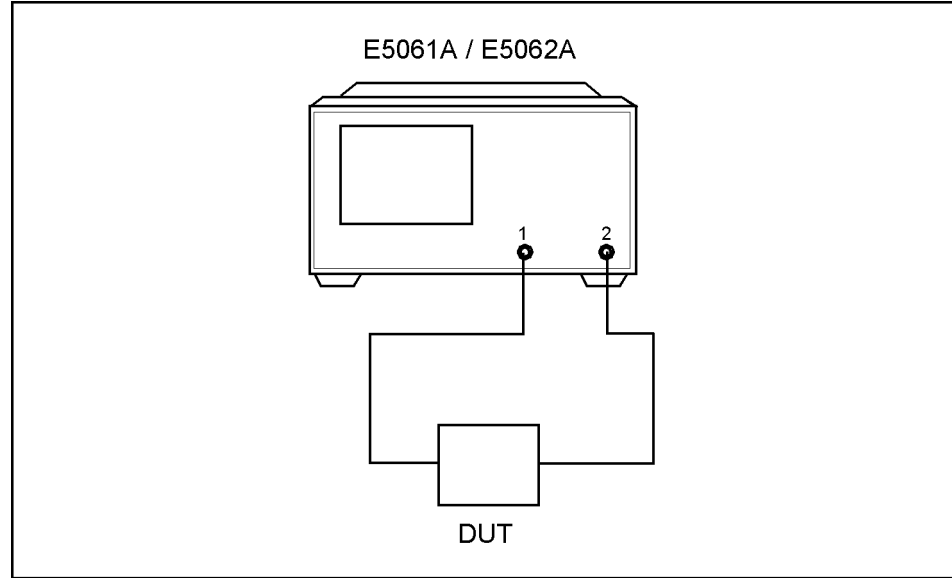

e5061auj016

### 6. Execute the Measurement

A trigger is applied to perform the measurement.

| Setup Description    | Key Operation                           |
|----------------------|---|
| Trigger mode: Single | <b>Trigger</b> - Single (Or Continuous) |

### 7. Define the Setup for Display

A choice is made between frequency base and order base as the segment display mode.

| Setup Description                             | Key Operation  |
|---|--|
| Segment display: Frequency base or order base | <b>Sweep Setup</b> - Segment Display - Frequency Base   Order Base |

Measurement Examples  
Measuring the SAW Bandpass Filter Using the Segment Sweep

Figure 11-5

Segment Display: Frequency Base

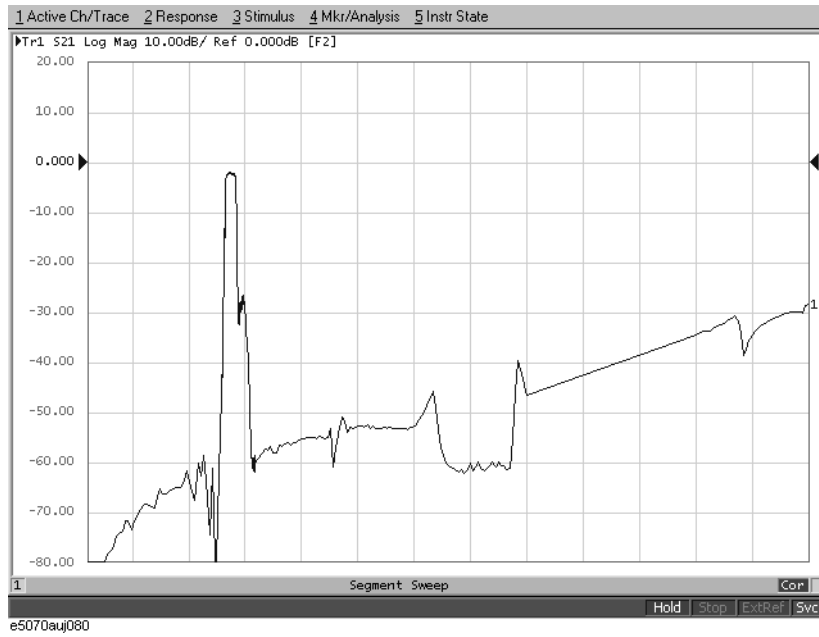
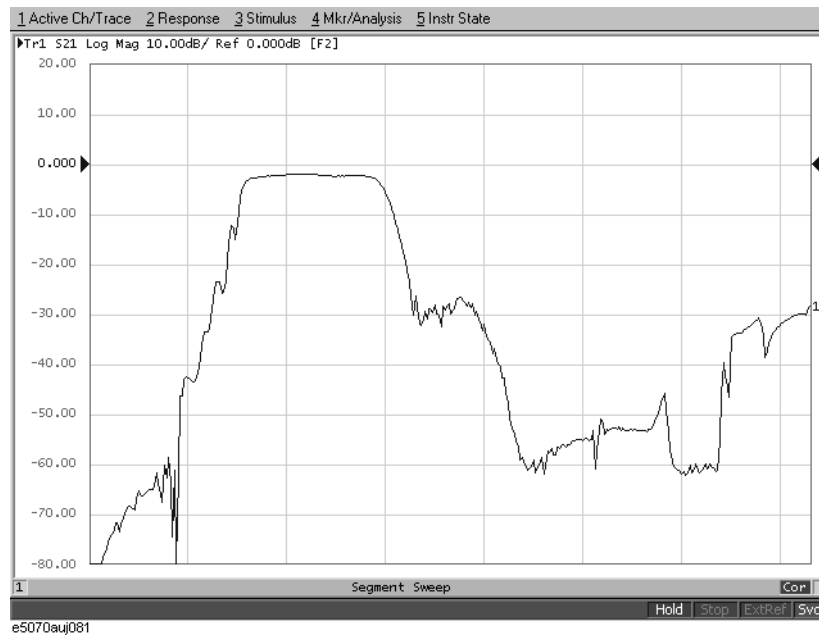

Figure 11-6

Segment Display: Order Base



## Measuring the Deviation from a Linear Phase

This section illustrates how to determine the deviation from a linear phase in the pass band of a 1.09 GHz bandpass filter.

### Evaluation Steps

Here, the DUT is evaluated by following the steps described in Table 11-3.

**Table 11-3** Evaluating the Deviation from a Linear Phase

| Step  | Description   |
|---|---|
| “1. Connect the DUT” on page 255                            | The DUT is connected.   |
| “2. Define the Measurement Conditions” on page 256          | The measurement conditions are defined.   |
| “3. Execute the Calibration” on page 256                    | The calibration is executed.  |
| “4. Connect the DUT and Execute the Auto Scale” on page 256 | The DUT is connected again to execute the auto scale function.                                      |
| “5. Specify the Electrical Delay” on page 257               | The electrical delay is specified.  |
| “6. Measure the Deviation from a Linear Phase” on page 258  | The statistics data function (peak-to-peak) is used to determine the deviation from a linear phase. |

### 1. Connect the DUT

Connect the DUT as shown in Figure 11-7.

**Figure 11-7** Connecting the DUT

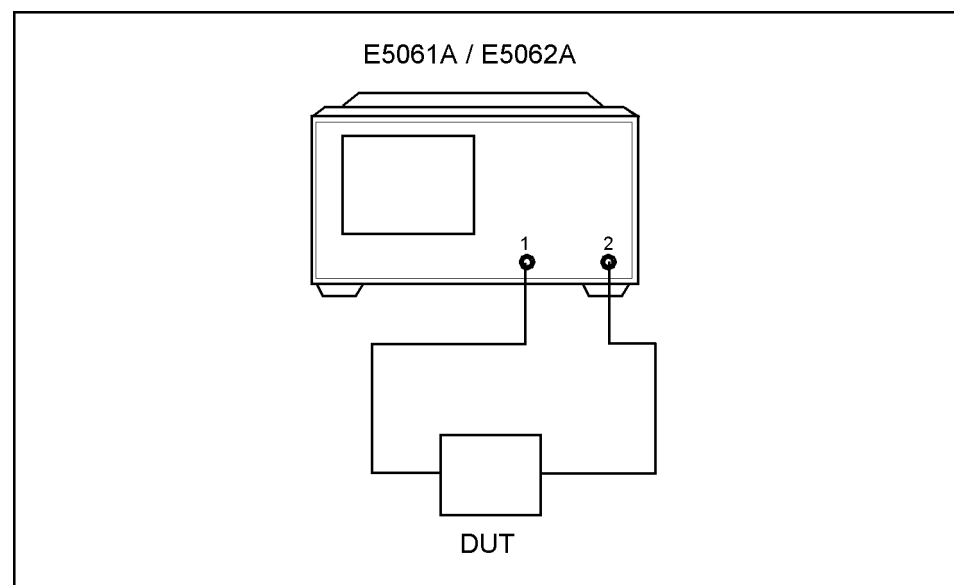

e5061auj017

## 2. Define the Measurement Conditions

The measurement conditions are defined by following the steps described below.

| Setup Description               | Key Operation  |
|---------------------------------|--|
| Presetting                      | <b>Preset</b> - <b>OK</b>                                    |
| Center frequency: 1.09 GHz      | <b>Center</b> <b>1</b> <b>.</b> <b>0</b> <b>9</b> <b>G/n</b> |
| Frequency span: 20 MHz          | <b>Span</b> <b>2</b> <b>0</b> <b>M/μ</b>                     |
| Measurement parameter: $S_{21}$ | <b>Meas</b> - $S_{21}$                                       |
| Data format: Expand Phase       | <b>Format</b> - <b>Expand Phase</b>                          |
| Executing the Auto Scale        | <b>Scale</b> - <b>Auto Scale</b>                             |

## 3. Execute the Calibration

The THRU response calibration is executed.

| Setup Description           | Key Operation   |
|-----------------------------|---|
| Executing the THRU response | (A THRU standard is connected instead of a DUT) <b>Cal</b> - <b>Calibrate - Response (Thru) - Thru - Done</b> |

## 4. Connect the DUT and Execute the Auto Scale

The DUT is connected again as shown in Figure 11-7 to execute the auto scale.

| Setup Description        | Key Operation                    |
|--------------------------|----------------------------------|
| Executing the auto scale | <b>Scale</b> - <b>Auto Scale</b> |

Figure 11-8

Phase Characteristics of the DUT

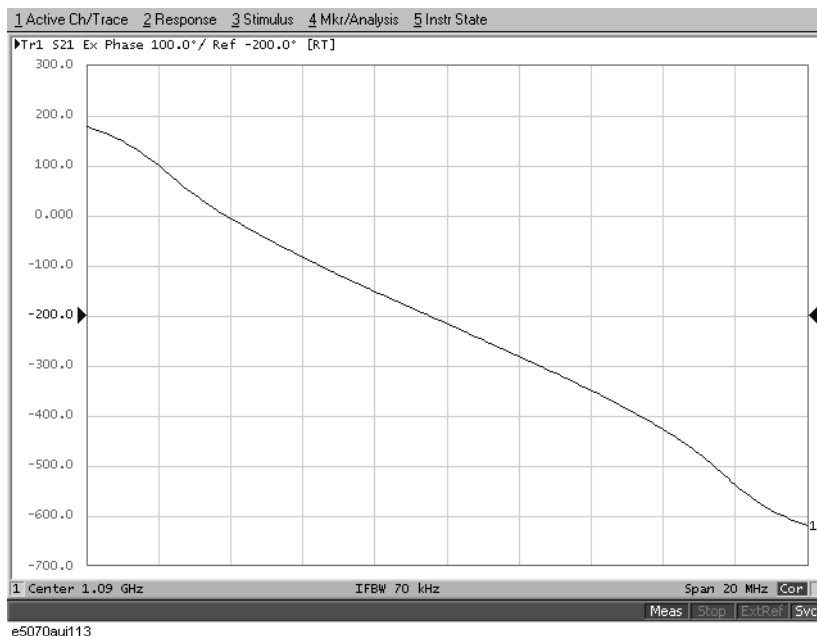

### 5. Specify the Electrical Delay

The electrical delay is entered to flatten the phase trace.

#### Setup Description

Entering the electrical delay

#### Key Operation

Scale - Electrical Delay - (Up Arrow) (Down Arrow) (Circle) (Flattening a trace)

Figure 11-9

Entering the Electrical Delay

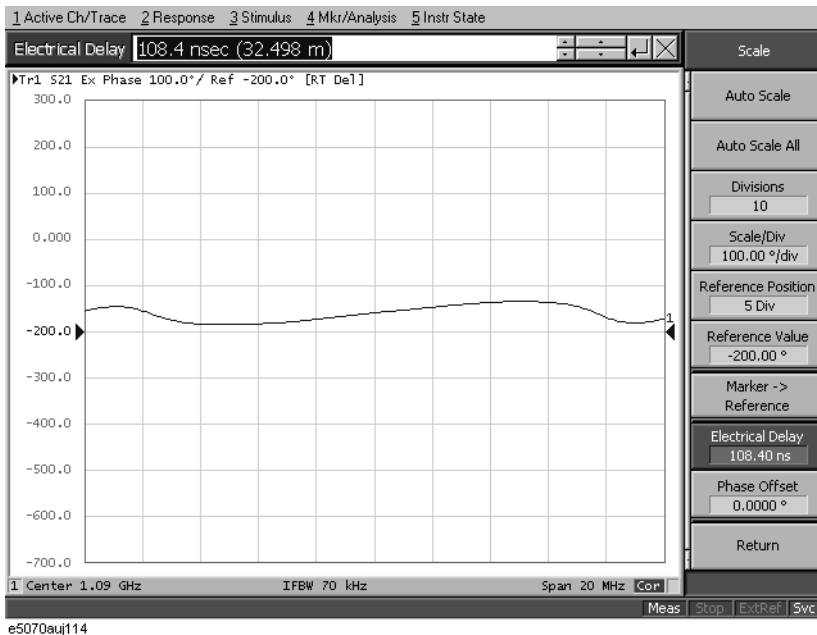

## 6. Measure the Deviation from a Linear Phase

The statistics data is used to read the deviation from a linear phase (peak-to-peak) (Figure 11-10).

| Setup Description              | Key Operation   |
|--------------------------------|---|
| Executing the auto scale       | <input type="button" value="Scale"/> - Auto Scale                     |
| Displaying the statistics data | <input type="button" value="Marker Fctn"/> - Statistics (Turn it ON.) |

Figure 11-10

Measuring the Deviation from a Linear Phase

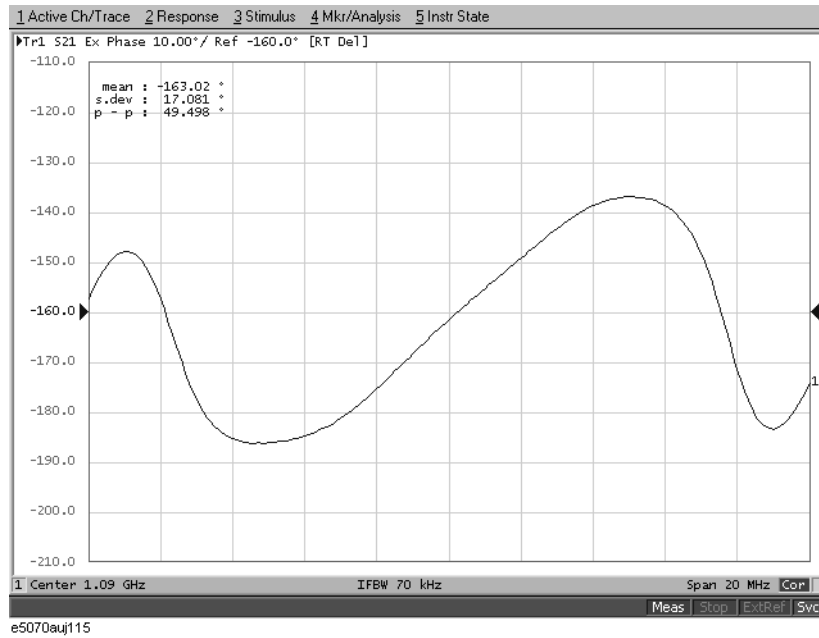



---

## 12 Specifications and Supplemental Information

This chapter provides specifications and supplemental information for the Agilent E5061A/E5062A Network Analyzer.

## Definitions

All specifications apply over a 5°C to 40°C range (unless otherwise stated) and 30 minutes after the instrument has been turned on.

**Specification (spec.):** Warranted performance. Specifications include guardbands to account for the expected statistical performance distribution, measurement uncertainties, and changes in performance due to environmental conditions.

Supplemental information is intended to provide information that is helpful for using the instrument but that is not guaranteed by the product warranty. This information is denoted as either typical or nominal.

**Typical (typ.):** Expected performance of an average unit that does not include guardbands. It is not guaranteed by the product warranty.

**Nominal (nom.):** A general, descriptive term that does not imply a level of performance. It is not guaranteed by the product warranty.

## Corrected System Performance

The specifications in this section apply for measurements made with the Agilent E5061A/E5062A Network Analyzer with the following conditions:

- No averaging applied to data
- Environmental temperature of 23°C ±5°C, with less than 1°C deviation from the calibration temperature
- Response and isolation calibration not omitted

**Table 12-1 System Dynamic Range**

| Description                              |                      | Specification | Supplemental Information |
|--|----------------------|---------------|--------------------------|
| <b>System Dynamic Range<sup>*1</sup></b> |                      |               |                          |
| 300 kHz to 3 GHz                         | IF bandwidth = 3 kHz | 90 dB         | 95 dB                    |
| 300 kHz to 3 GHz                         | IF bandwidth = 10 Hz | 115 dB        | 120 dB                   |

\*1. The test port dynamic range is calculated as the difference between the test port rms noise floor and the source maximum output power. The effective dynamic range must take measurement uncertainty and interfering signals into account.

**Table 12-2 Corrected System Performance With Type-N Device Connectors, 85032F Calibration Kit**

| Network analyzer: E5061A/E5062A, Calibration kit: 85032F (Type-N, 50 Ω), Calibration: full 2-port  |                    |                  |
|--|--------------------|------------------|
| IF bandwidth = 10 Hz, No averaging applied to data, Environmental temperature = 23°C±5°C with <1°C deviation from calibration temperature, Isolation calibration not omitted |                    |                  |
| Description  | Specification (dB) |                  |
|  | 300 KHz to 1.5 GHz | 1.5 GHz to 3 GHz |
| Directivity  | 49                 | 46               |
| Source Match   | 41                 | 40               |
| Load Match   | 49                 | 46               |
| Reflection Tracking  | ±0.011             | ±0.021           |
| Transmission Tracking  | ±0.015             | ±0.018           |

**Transmission Uncertainty (Specification)**

**Magnitude**

**Phase**

  

**Reflection Uncertainty (Specification)**

**Magnitude**

**Phase**

**Table 12-3 Corrected System Performance With Type-N Device Connectors, 85032F Calibration Kit**

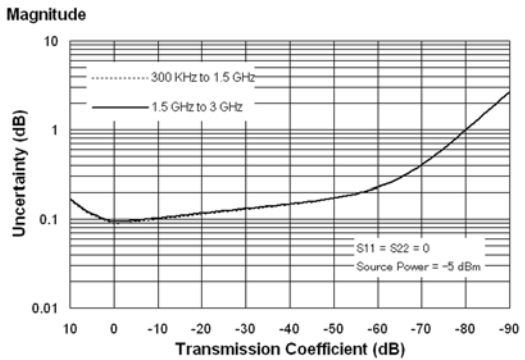
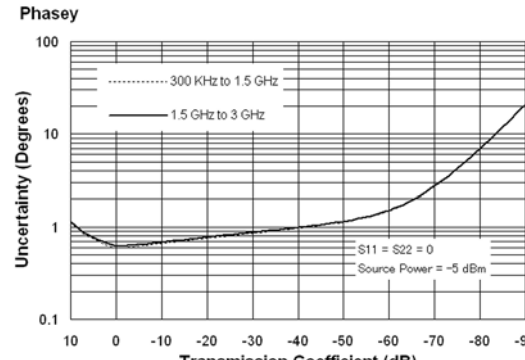
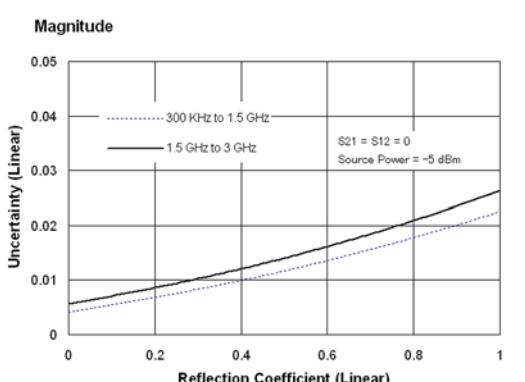
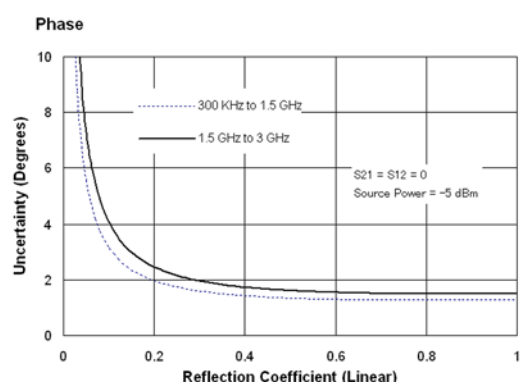
| Network analyzer: E5061A/E5062A, Calibration kit: 85032F (Type-N, 50 Ω) , Calibration: enhanced response  |                    |   |
|---|--------------------|---|
| IF bandwidth = 10 Hz, No averaging applied to data, Environmental temperature = 23°C±5°C with <1°C deviation from calibration temperature, Isolation calibration not omitted  |                    |   |
| Description   | Specification (dB) |   |
|   | 300 KHz to 1.5 GHz | 1.5 GHz to 3 GHz  |
| Directivity   | 49                 | 46  |
| Source Match  | 41                 | 40  |
| Load Match  | 15                 | 15  |
| Reflection Tracking   | ±0.011             | ±0.021  |
| Transmission Tracking   | ±0.015             | ±0.018  |
| <b>Transmission Uncertainty (Specification)</b>   |                    |   |
|  <p>Magnitude<br/>Uncertainty (dB)<br/>Transmission Coefficient (dB)</p> <p>Legend:<br/>- - - 300 KHz to 1.5 GHz<br/>— 1.5 GHz to 3 GHz</p> <p>Parameters:<br/>S11 = S22 = 0<br/>Source Power = -5 dBm</p>        |                    |  <p>Phase<br/>Uncertainty (Degrees)<br/>Transmission Coefficient (dB)</p> <p>Legend:<br/>- - - 300 KHz to 1.5 GHz<br/>— 1.5 GHz to 3 GHz</p> <p>Parameters:<br/>S11 = S22 = 0<br/>Source Power = -5 dBm</p>    |
| <b>Reflection Uncertainty (Specification)</b>   |                    |   |
|  <p>Magnitude<br/>Uncertainty (Linear)<br/>Reflection Coefficient (Linear)</p> <p>Legend:<br/>- - - 300 KHz to 1.5 GHz<br/>— 1.5 GHz to 3 GHz</p> <p>Parameters:<br/>S21 = S12 = 0<br/>Source Power = -5 dBm</p> |                    |  <p>Phase<br/>Uncertainty (Degrees)<br/>Reflection Coefficient (Linear)</p> <p>Legend:<br/>- - - 300 KHz to 1.5 GHz<br/>— 1.5 GHz to 3 GHz</p> <p>Parameters:<br/>S21 = S12 = 0<br/>Source Power = -5 dBm</p> |

12. Specifications and Supplemental Information

**Table 12-4** Corrected System Performance With Type-N 75Ω Device Connectors, 85036E Calibration Kit

| Network analyzer: E5061A/E5062A, Calibration kit: 85036E (Type-N, 75 Ω), Calibration: full 2-port  |                    |                  |
|--|--------------------|------------------|
| IF bandwidth = 10 Hz, No averaging applied to data, Environmental temperature = 23°C±5°C with <1°C deviation from calibration temperature, Isolation calibration not omitted |                    |                  |
| Description  | Specification (dB) |                  |
|  | 300 KHz to 1.5 GHz | 1.5 GHz to 3 GHz |
| Directivity  | 48                 | 44               |
| Source Match   | 41                 | 35               |
| Load Match   | 48                 | 44               |
| Reflection Tracking  | ±0.010             | ±0.019           |
| Transmission Tracking  | ±0.015             | ±0.029           |

**Transmission Uncertainty (Specification)**

**Magnitude**

Uncertainty (dB)

Transmission Coefficient (dB)

300 KHz to 1.5 GHz  
1.5 GHz to 3 GHz

S11 = S22 = 0  
Source Power = -5 dBm

**Phase**

Uncertainty (Degrees)

Transmission Coefficient (dB)

300 KHz to 1.5 GHz  
1.5 GHz to 3 GHz

S11 = S22 = 0  
Source Power = -5 dBm

**Reflection Uncertainty (Specification)**

**Magnitude**

Uncertainty (Linear)

Reflection Coefficient (Linear)

300 KHz to 1.5 GHz  
1.5 GHz to 3 GHz

S21 = S12 = 0  
Source Power = -5 dBm

**Phase**

Uncertainty (Degrees)

Reflection Coefficient (Linear)

300 KHz to 1.5 GHz  
1.5 GHz to 3 GHz

S21 = S12 = 0  
Source Power = -5 dBm

**Table 12-5 Corrected System Performance With Type-N 75Ω Device Connectors, 85036E Calibration Kit**

| Network analyzer: E5061A/E5062A, Calibration kit: 85036E (Type-N, 75 Ω) Calibration: enhanced response   |                    |                  |
|--|--------------------|------------------|
| IF bandwidth = 10 Hz, No averaging applied to data, Environmental temperature = 23°C±5°C with <1°C deviation from calibration temperature, Isolation calibration not omitted |                    |                  |
| Description  | Specification (dB) |                  |
|  | 300 KHz to 1.5 GHz | 1.5 GHz to 3 GHz |
| Directivity  | 48                 | 44               |
| Source Match   | 41                 | 35               |
| Load Match   | 15                 | 15               |
| Reflection Tracking  | ±0.010             | ±0.019           |
| Transmission Tracking  | ±0.015             | ±0.029           |

12. Specifications and Supplemental Information

**Transmission Uncertainty (Specification)**

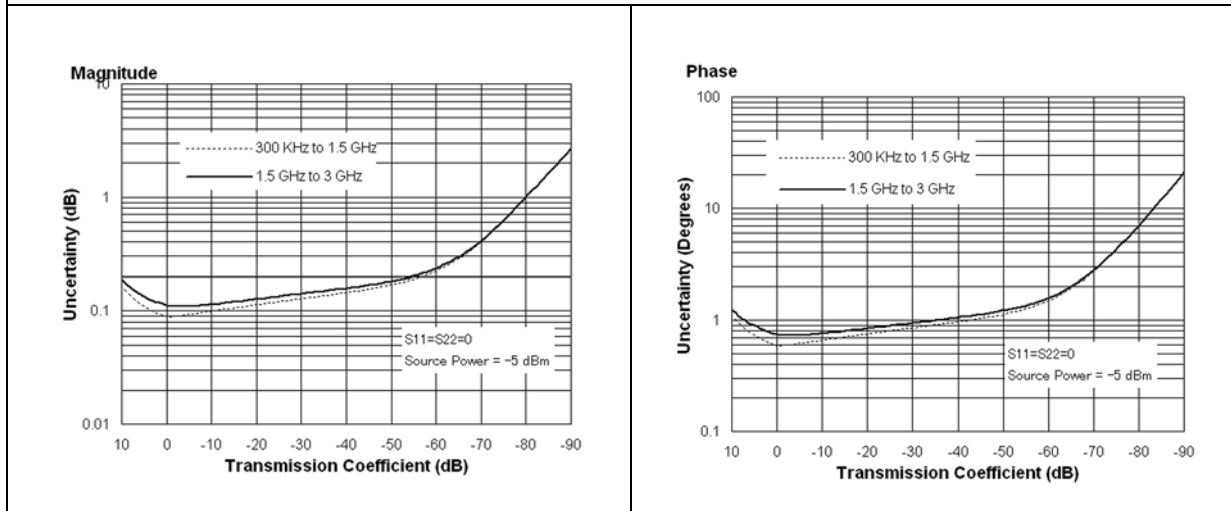

**Reflection Uncertainty (Specification)**

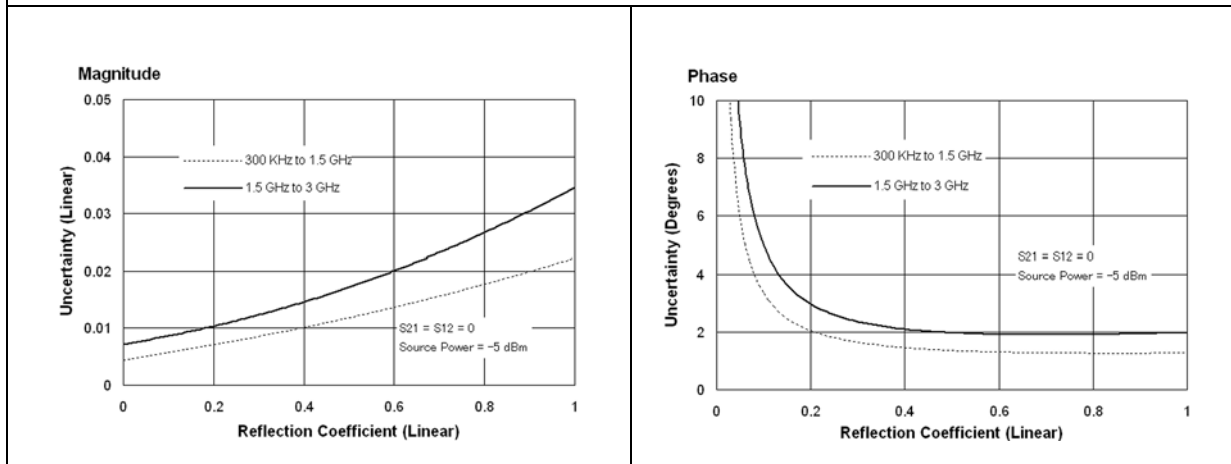

---

## Uncorrected System Performance

**Table 12-6**

**Uncorrected System Performance (Correction: Off)**

| Description           | Specification  |
|-----------------------|----------------|
|                       | 3 MHz to 3 GHz |
| Directivity           | 25 dB          |
| Source Match          | 25 dB          |
| Load Match            | 15 dB          |
| Transmission Tracking | $\pm 1.0$ dB   |
| Reflection Tracking   | $\pm 1.0$ dB   |



## Test Port Output (Source)

**Table 12-7** Test Port Output Frequency

| Description                       | Specification                          | Supplemental Information      |
|-----------------------------------|--|-------------------------------|
| Range<br>E5061A<br>E5062A         | 300 kHz to 1.5 GHz<br>300 kHz to 3 GHz |                               |
| Resolution                        | 1 Hz                                   |                               |
| Source Stability<br>E5061A/E5062A |  | ±5 ppm (5°C to 40°C, typical) |
| CW Accuracy<br>E5061A/E5062A      | ±5 ppm, 23°C±5°C                       |                               |

**Table 12-8** Test Port Output Power

| Description   | Specification   | Supplemental Information   |
|---|---|--|
| Level Accuracy (at 23°C±5°C)<br>300 kHz to 3 GHz* <sup>1</sup>                  | ±0.8 dB (at 0 dBm, 50 MHz<br>absolute)<br>±1.0 dB (at 0 dBm, relative to 50<br>MHz reference) |  |
| Level Linearity (at 23°C±5°C)<br>300 KHz to 3 GHz                               | ±0.75 dB (at -5 dBm to 10 dBm)  |  |
| Range<br>Standard<br>300 kHz to 3 GHz<br><br>Extended Power<br>300 kHz to 3 GHz | -5 dBm to 10 dBm  | -45 dBm to 10 dBm<br>(non-harmonics spurious may<br>limit power range) |
| Sweep Range (without extended power range)<br>300 kHz to 3 GHz                  | -5 dBm to 10 dBm  |  |
| Level Resolution  | 0.05 dB   |  |

\*1. Level accuracy for 75 ohm analyzer is not a specification for frequency > 2 GHz; it is a characteristic.

**Table 12-9** Test Port Output Signal Purity

| Description                               | Specification | Supplemental Information      |
|---|---------------|-------------------------------|
| Harmonics (2nd or 3rd)<br>10 MHz to 2 GHz |               | < -25 dBc (at 5 dBm, typical) |
| Non-Harmonic Spurious<br>10 MHz to 3 GHz  |               | < -30 dBc (at 5 dBm, typical) |

## Test Port Input

**Table 12-10 Test Port Input Levels**

| Description                          | Specification | Supplemental Information       |
|--------------------------------------|---------------|--------------------------------|
| <b>Maximum Test Port Input Level</b> |               |                                |
| 300 kHz to 3 GHz                     | +10 dBm       |                                |
| <b>Damage Level</b>                  |               |                                |
| 300 kHz to 3 GHz                     |               | +20 dBm, $\pm 30$ VDC, typical |
| <b>Crosstalk <sup>*1</sup></b>       |               |                                |
| 300 KHz to 3 GHz                     | -110 dB       |                                |

\*1. Response calibration not omitted.

**Table 12-11 Test Port Input (Trace Noise)**

| Description  | Specification               | Supplemental Information |
|--|-----------------------------|--------------------------|
| <b>Trace Noise <sup>*1</sup> Magnitude</b>         |                             |                          |
| 300 kHz to 1 MHz<br>(source power level = +10 dBm) | 8 mdB rms (23°C $\pm$ 5°C)  |                          |
| 1 MHz to 3 GHz<br>(source power level = +10 dBm)   | 5 mdB rms (23°C $\pm$ 5°C)  |                          |
| <b>Trace Noise <sup>*1</sup> Phase</b>             |                             |                          |
| 300 kHz to 1 MHz<br>(source power level = +10 dBm) | 0.05 ° rms (23°C $\pm$ 5°C) |                          |
| 1 MHz to 3 GHz<br>(source power level = +10 dBm)   | 0.03 ° rms (23°C $\pm$ 5°C) |                          |

\*1. Trace noise is defined as a ratio measurement of a through, at IFBW = 3 kHz.

**Table 12-12 Test Port Input (Stability)**

| Description                             | Specification | Supplemental Information              |
|---|---------------|---------------------------------------|
| <b>Stability Magnitude<sup>*1</sup></b> |               |                                       |
| 3 MHz to 3 GHz                          |               | 0.01 dB/°C<br>(at 23 °C±5°C, typical) |
| <b>Stability Phase<sup>*1</sup></b>     |               |                                       |
| 3 MHz to 3 GHz                          |               | 0.1 °/°C<br>(at 23 °C±5°C, typical)   |

\*1. Stability is defined as a ratio measurement at the test port.

**Table 12-13 Test Port Input (Dynamic Accuracy)**

| Accuracy of the test port input power reading is relative to -10 dBm reference input power level. |  |
|---|--|
| Specification   | Supplemental Information   |
| <p>Magnitude</p> <p>Accuracy [dB]</p> <p>Testport Power [dBm]</p>                                 | <p>Phase</p> <p>Accuracy [degrees]</p> <p>Testport Power [dBm]</p> |

**Table 12-14 Test Port Input (Group Delay)<sup>\*1</sup>**

| Description           | Specification                           | Supplemental Information  |
|-----------------------|---|---|
| Aperture (selectable) | (frequency span)/(number of points – 1) |   |
| Maximum Aperture      | 25% of frequency span                   |   |
| Maximum Delay         |   | Limited to measuring no more than 180° of phase change within the minimum aperture. |
| Accuracy              |   | See graph below, typical  |

The following graph shows group delay accuracy with type-N full 2-port calibration and a 10 Hz IF bandwidth. Insertion loss is assumed to be < 2 dB.

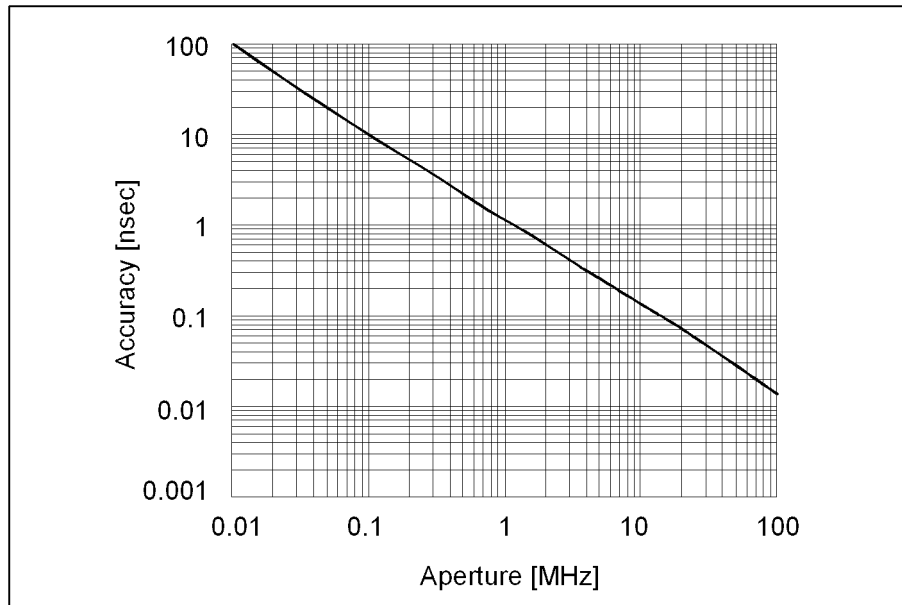

In general, the following formula can be used to determine the accuracy, in seconds, of specific group delay measurement:

$$\pm \text{Phase Accuracy (deg)} / [360 \times \text{Aperture (Hz)}]$$

<sup>\*1</sup> Group delay is computed by measuring the phase change within a specified step (determined by the frequency span and the number of points per sweep).

## General Information

**Table 12-15 System Bandwidths**

| Description                  | Supplemental Information   |
|------------------------------|--|
| <b>IF Bandwidth Settings</b> |  |
| Range                        | 10 Hz to 30 kHz<br>Nominal settings are:<br>10, 30, 100, 300, 1k, 3k, 10k, 30k |

**Table 12-16 Front Panel Information**

| Description          | Supplemental Information                             |
|----------------------|--|
| <b>RF Connectors</b> |  |
| Type                 | Type-N, female, 50 $\Omega$ or 75 $\Omega$ (nominal) |
| <b>Display</b>       |  |
| Size                 | 10.4 in TFT color LCD                                |
| Resolution           | VGA (640 $\times$ 480) <sup>*1</sup>                 |

\*1. Valid pixels are 99.99 % and more. Below 0.01 % (approx. 30 points) of fixed points of black, blue, green or red are not regarded as failure.

**Table 12-17 Rear Panel Information**





| Description                                       | Supplemental Information  |
|---|---|
| <b>External Trigger Connector</b>                 |   |
| Type  | BNC, female   |
| Input level                                       | LOW threshold voltage: 0.5 V<br>HIGH threshold voltage: 2.1 V<br>Input level range: 0 to + 5 V  |
| Pulse width                                       | ≥ 20 μsec, typical  |
| Polarity  | Negative (downward) only  |
| <b>External Reference Signal Input Connector</b>  |   |
| Type  | BNC, female   |
| Input Frequency                                   | 10 MHz ± 10 ppm, typical  |
| Input Level                                       | 0 dBm ± 3 dB, typical   |
| <b>Internal Reference Signal Output Connector</b> |   |
| Type  | BNC, female   |
| Output Frequency                                  | 10 MHz ± 10 ppm, typical  |
| Signal Type                                       | Sine Wave, typical  |
| Output Level                                      | 0 dBm ± 3 dB into 50 Ω, typical   |
| Output Impedance                                  | 50 Ω, nominal   |
| <b>VGA Video Output</b>                           | 15-pin mini D-Sub; female; drives VGA compatible monitors   |
| <b>GPIB</b>                                       | 24-pin D-Sub (Type D-24), female; compatible with IEEE-488  |
| <b>Parallel Port</b>                              | 36-pin D-Sub (Type 1284-C), female; provides connection to printers, or multiport test set  |
| <b>USB Port</b>                                   |   |
| Contact 1   | Universal Serial Bus jack, Type A configuration (4 contacts inline, contact 1 on left); female; provides connection to printer, ECal module, USB/GPIB interface<br>Vcc: 4.75 to 5.25 VDC, 500 mA, maximum |
| Contact 2   | -Data   |
| Contact 3   | +Data   |
| Contact 4   | Ground  |
| <b>LAN</b>  | 10/100BaseT Ethernet, 8-pin configuration; auto selects between the two data rates  |
| <b>Handler I/O Port</b>                           | 36-pin D-sub, female; provides connection to handler system   |

**Table 12-17 Rear Panel Information**

| Description          | Supplemental Information                                  |
|----------------------|---|
| <b>Line Power</b> *1 |   |
| Frequency            | 47 Hz to 63 Hz  |
| Voltage              | 90 to 132 VAC, or 198 to 264 VAC (automatically switched) |
| VA Max               | 350 VA max.   |

\*1. A third-wire ground is required.

**Table 12-18 EMC and Safety**

| Description   | Supplemental Information   |
|---|--|
| <b>EMC</b>  |  |
| <br><b>ISM 1-A</b>   | European Council Directive 89/336/EEC, 92/31/EEC, 93/68/EEC<br>IEC 61326-1:1997 +A1:1998 +A2:2000/EN 61326-1:1997 +A1:1998 +A2:2001<br>CISPR 11:1997 +A1:1999/EN 55011:1998 +A1:1999<br>Group 1, Class A<br>IEC 61000-4-2:1995 +A1:1998/EN 61000-4-2:1995 +A1:1998<br>4 kV CD / 8 kV AD<br>IEC 61000-4-3:1995 +A1:1998/EN 61000-4-3:1996 +A1:1998<br>3 V/m, 80-1000 MHz, 80% AM<br>IEC 61000-4-4:1995/EN 61000-4-4:1995<br>1 kV power / 0.5 kV Signal<br>IEC 61000-4-5:1995/EN 61000-4-5:1995<br>0.5 kV Normal / 1 kV Common<br>IEC 61000-4-6:1996/EN 61000-4-6:1996<br>3 V, 0.15-80 MHz, 80% AM<br>IEC 61000-4-11:1994/EN 61000-4-11:1994<br>100% 1cycle European Council Directive |
| <b>ICES/NMB-001</b>   | This ISM device complies with Canadian ICES-001:1998.<br>Cet appareil ISM est conforme a la norme NMB-001 du Canada.   |
|  <b>N10149</b>     | AS/NZS 2064.1/2 Group 1, Class A   |
| <b>Safety</b>   |  |
| <br><b>ISM 1-A</b> | European Council Directive 73/23/EEC, 93/68/EEC<br>IEC 61010-1:2001/EN 61010-1:2001<br>Measurement Category I, Pollution Degree 2, Indoor Use<br>IEC60825-1:1994 Class 1 LED   |
|  <b>LR95111C</b>   | CAN/CSA C22.2 No. 1010.1-92  |

**Table 12-18**      **EMC and Safety**

| Description   | Supplemental Information   |
|---|--|
| <b>Environment</b>  |  |
|  | <p>This product complies with the WEEE Directive (2002/96/EC) marking requirements. The affixed label indicates that you must not discard this electrical/ electronic product in domestic household waste.</p> <p>Product Category : With reference to the equipment types in the WEEE Directive Annex I, this product is classed as a “Monitoring and Control instrumentation” product.</p> <p>Do not dispose in domestic household waste.</p> <p>To return unwanted products, contact your local Agilent office, or see <a href="http://www.agilent.com/environment/product/">www.agilent.com/environment/product/</a> for more information.</p> |



**Table 12-19 Analyzer Environment and Dimensions**

| Description                              | Supplemental Information                                       |
|--|--|
| <b>Operating Environment</b>             |  |
| Temperature                              | +5 °C to +40 °C  |
| Error-Corrected Temperature Range        | 23 °C ± 5 °C with < 1°C deviation from calibration temperature |
| Humidity                                 | 20% to 80% at wet bulb temperature < +29 °C (non-condensing)   |
| Altitude                                 | 0 to 2,000 m (0 to 6,561 feet)                                 |
| Vibration                                | 0.5 G maximum, 5 Hz to 500 Hz                                  |
| <b>Non-Operating Storage Environment</b> |  |
| Temperature                              | -10 °C to +60 °C   |
| Humidity                                 | 20% to 90% at wet bulb temperature < +40 °C (non-condensing)   |
| Altitude                                 | 0 to 4,572 m (0 to 15,000 feet)                                |
| Vibration                                | 0.5 G maximum, 5 Hz to 500 Hz                                  |
| <b>Dimensions</b>                        | See Figure 12-1 through Figure 12-3.                           |
| <b>Weight (Net)</b>                      | 13.5 kg  |

**Figure 12-1 Dimensions (front view, in millimeters, nominal)**

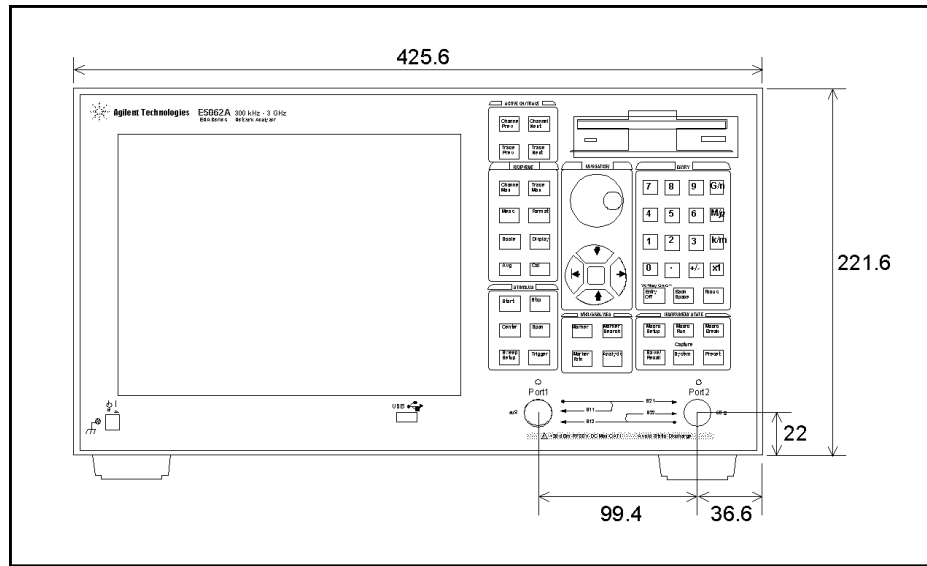

e5061aue023

Figure 12-2 Dimensions (rear view, in millimeters, nominal)

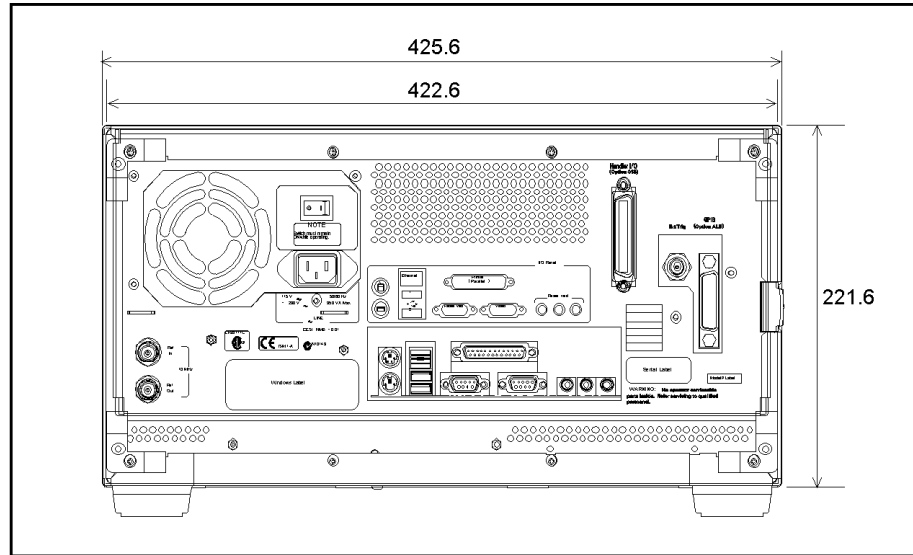
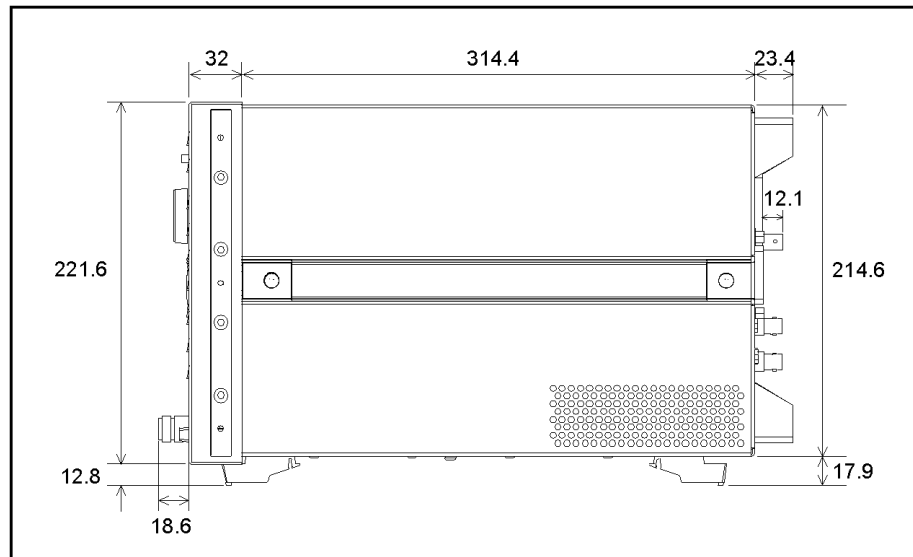

Figure 12-3 Dimensions (side view, in millimeters, nominal)



## Measurement Throughput Summary

**Table 12-20** Typical Cycle Time for Measurement Completion <sup>\*1</sup> (ms) (Display Update:OFF)

|   | Number of Points |     |     |      |
|---|------------------|-----|-----|------|
|   | 51               | 201 | 401 | 1601 |
| <b>Start 1 GHz, Stop 1.2 GHz, 30 kHz IF bandwidth</b>   |                  |     |     |      |
| Uncorrected   | 8                | 19  | 33  | 117  |
| 2-port cal  | 14               | 35  | 63  | 230  |
| <b>Start 300 kHz, Stop 1.5 GHz, 30 kHz IF bandwidth</b> |                  |     |     |      |
| Uncorrected   | 15               | 25  | 39  | 123  |
| 2-port cal  | 27               | 48  | 75  | 243  |
| <b>Start 300 kHz, Stop 3 GHz, 30 kHz IF bandwidth</b>   |                  |     |     |      |
| Uncorrected   | 17               | 28  | 41  | 125  |
| 2-port cal  | 31               | 53  | 80  | 247  |

\*1. Typical performance.

**Table 12-21** Typical Cycle Time for Measurement Completion <sup>\*1</sup> (ms) (Display Update:ON)

|   | Number of Points |     |     |      |
|---|------------------|-----|-----|------|
|   | 51               | 201 | 401 | 1601 |
| <b>Start 1 GHz, Stop 1.2 GHz, 30 kHz IF bandwidth</b>   |                  |     |     |      |
| Uncorrected   | 59               | 68  | 83  | 172  |
| 2-port cal  | 85               | 103 | 131 | 304  |
| <b>Start 300 kHz, Stop 1.5 GHz, 30 kHz IF bandwidth</b> |                  |     |     |      |
| Uncorrected   | 64               | 74  | 89  | 178  |
| 2-port cal  | 95               | 116 | 144 | 317  |
| <b>Start 300 kHz, Stop 3 GHz, 30 kHz IF bandwidth</b>   |                  |     |     |      |
| Uncorrected   | 66               | 78  | 91  | 180  |
| 2-port cal  | 98               | 121 | 148 | 322  |

\*1. Typical performance.

**Table 12-22 Data Transfer Time<sup>\*1</sup> (ms)**

|   | Number of Points |     |     |      |
|---|------------------|-----|-----|------|
|   | 51               | 201 | 401 | 1601 |
| <b>SCPI over GPIB<sup>*2</sup></b>                    |                  |     |     |      |
| REAL 64   | 6                | 14  | 25  | 89   |
| ASCII   | 51               | 193 | 383 | 1522 |
| <b>SCPI over 100 Mbps LAN (Telnet)<sup>*2</sup></b>   |                  |     |     |      |
| REAL 64   | 3                | 3   | 4   | 6    |
| ASCII   | 92               | 354 | 510 | 2040 |
| <b>SCPI over 100 Mbps LAN (SICL-LAN)<sup>*2</sup></b> |                  |     |     |      |
| REAL 64   | 7                | 7   | 8   | 12   |
| ASCII   | 9                | 21  | 34  | 127  |
| <b>COM<sup>*2</sup></b>                               |                  |     |     |      |
| Variant type  | 2                | 2   | 2   | 2    |

\*1. Typical performance.

\*2. Measured using a VEE 6.01 program running on a 500 MHz Pentium III Dell Optiplex, Transferred complex S<sub>11</sub> data, using :CALC:DATA?SDAT.

## Measurement capabilities

|  |  |
|--|--|
| <b>Number of measurement channels</b>        | Up to 4 independent measurement channels. A measurement channel is coupled to stimulus response settings including frequency, IF bandwidth, power level, and number of points.   |
| <b>Number of display windows</b>             | Each measurement channel has a display window. Up to 4 display windows (channels) can be displayed.  |
| <b>Number of traces</b>                      | 4 data traces and 4 memory traces per channel  |
| <b>Measurement choices</b>                   | Option E5061A/E5062A-150/175: $S_{11}$ , $S_{21}$<br>Option E5061A/E5062A-250/275: $S_{11}$ , $S_{21}$ , $S_{12}$ , $S_{22}$   |
| <b>Measurement parameter conversion</b>      | Available to convert S-parameters into reflection impedance, transmission impedance, reflection admittance, transmission admittance, and 1/S.  |
| <b>Data formats</b>                          | Log magnitude, linear magnitude, phase, expanded phase, positive phase, group delay, SWR, real, imaginary, Smith chart, polar.   |
| <b>Data markers</b>                          | 10 independent markers per trace. Reference marker available for delta marker operation. Smith chart format includes 5 marker formats: linear magnitude/phase, log magnitude/phase, real/imaginary, $R + jX$ , and $G + jB$ . Polar chart format includes 3 marker formats: linear magnitude/phase, log magnitude/phase, and real/imaginary. |
| <b>Marker functions</b>                      |  |
| <b>Marker search</b>                         | Max value, Min value, peak, peak left, peak right, target, target left, target right, multi-peak, multi-target, bandwidth parameters with user-defined bandwidth values.   |
| <b>Marker-to functions</b>                   | Set start, stop, center to active marker stimulus value; set reference to active marker response value; set electrical delay to group delay at active marker.  |
| <b>Search range</b>                          | User definable.  |
| <b>Tracking</b>                              | Performs marker search continuously or on demand.  |
| <b>Fault location functions (option 100)</b> |  |
| <b>Transformation</b>                        | Selectable transformation type from bandpass, lowpass impulse, lowpass step.<br>Selectable window from maximum, normal and minimum.  |

## Source control

|  |  |
|--|--|
| <b>Measured number of points per sweep</b> | User definable from 2 to 1601.   |
| <b>Sweep type</b>                          | Linear sweep, segment sweep, log sweep and power sweep.  |
| <b>Segment sweep</b>                       | Define independent sweep segments. Set number of points, test port power levels, IF bandwidth, delay time, sweep time and sweep mode independently for each segment. |
| <b>Sweep trigger</b>                       | Set to continuous, hold, or single, sweep with internal, external, manual, or bus trigger.   |
| <b>Power</b>                               | Set source power from -5 dBm (-45 dBm for option E5061A/E5062A-250/275/1E1) to 10 dBm. The power slope function compensates source power level error.                |

## Trace functions

|                         |   |
|-------------------------|---|
| <b>Display data</b>     | Display current measurement data, memory data, or current measurement and memory data simultaneously. |
| <b>Trace math</b>       | Vector addition, subtraction, multiplication or division of measured complex values and memory data.  |
| <b>Title</b>            | Add custom title to each channel window. Titles are printed on hardcopies of displayed measurements.  |
| <b>Autoscale</b>        | Automatically selects scale resolution and reference value to vertically center the trace.            |
| <b>Electrical delay</b> | Offset measured phase or group delay by a defined amount of electrical delay, in seconds.             |
| <b>Phase Offset</b>     | Offset measured phase or group delay by a defined amount in degrees.                                  |
| <b>Statistics</b>       | Calculates and displays mean, standard deviation and peak-to-peak deviation of the data trace.        |

## Data accuracy enhancement

|   |  |
|---|--|
| <b>Measurement calibration</b>                    | Measurement calibration significantly reduces measurement uncertainty due to errors caused by system directivity, source and load match, tracking and crosstalk. Full 2-port, calibration removes all the systematic errors for the related test ports to obtain the most accurate measurements. |
| <b>Calibration types available</b>                |  |
| <b>Response</b>                                   | Simultaneous magnitude and phase correction of frequency response errors for either reflection or transmission measurements.   |
| <b>Response and isolation</b>                     | Compensates for frequency response and crosstalk errors of transmission measurements.  |
| <b>Enhanced response</b>                          | Compensates for frequency response and source match errors.  |
| <b>One-port calibration</b>                       | Correct for directivity, frequency response and source match errors.   |
| <b>Full 2-port (Option E5061A/E5062A-250/275)</b> | Compensates for directivity, source match, reflection tracking, load match, transmission tracking and crosstalk. Crosstalk calibration can be omitted.   |
| <b>Interpolated error correction</b>              | With any type of accuracy enhancement applied, interpolated mode recalculates the error coefficients when the test frequencies are changed. The number of points can be increased or decreased and the start/stop frequencies can be changed.  |
| <b>Velocity factor</b>                            | Enter the velocity factor to calculate the equivalent physical length.   |
| <b>Reference port extension</b>                   | Redefine the measurement plane from the plane where the calibration was done.  |

---

## Storage

|                                 |  |
|---------------------------------|--|
| <b>Internal hard disk drive</b> | Store and recall instrument states, calibration data, and trace data on 10 GB, minimum, internal hard drive. Trace data can be saved in CSV (comma separated value) format. All files are MS-DOS® -compatible. Instrument states include all control settings, limit lines, segment sweep tables, and memory trace data. |
| <b>File sharing</b>             | Internal hard disk drive (D:) can be accessed from an external Windows® PC through LAN.  |
| <b>Disk drive</b>               | Instrument states, calibration data, and trace data can be stored on an internal 3.5 inch 1.4MB floppy disk in MS-DOS® -compatible format.   |
| <b>Screen hardcopy</b>          | Printouts of instrument data are directly produced on a printer. The analyzer provides USB and parallel interfaces.  |

---

## System capabilities

|  |   |
|--|---|
| <b>Familiar graphical user interface</b> | The ENA-L analyzer employs a graphical user interface based on Windows® operating system. There are three ways to operate the instrument manually: you can use a hardkey interface, a touch screen interface (Option E5061A/E5062A-016) or a mouse interface. |
| <b>Limit lines</b>                       | Define the test limit lines that appear on the display for pass/fail testing. Defined limits may be any combination of horizontal/sloping lines and discrete data points.   |



## Automation

| Methods                            |  |
|------------------------------------|--|
| <b>Internal analyzer execution</b> | Applications can be developed in a built-in VBA® (Visual Basic for Applications) language. Applications can be executed from within the analyzer via COM (component object model) or using SCPI.     |
| <b>Controlling via GPIB</b>        | The GPIB interface operates to IEEE 488.2 and SCPI protocols. The analyzer can be controlled by a GPIB external controller.<br>The analyzer can control external devices using a USB/GPIB interface. |
| LAN                                |  |
| <b>Standard conformity</b>         | 10 Base-T or 100 Base-TX (automatically switched), Ethertwist, RJ45 connector  |
| <b>Protocol</b>                    | TCP/IP   |
| <b>Function</b>                    | Telnet, SICL-LAN   |



---

## **13**      **Information on Maintenance**

This chapter explains the measures you should take to maintain the Agilent E5061A/E5062A.

## **Backing Up the Data**

Be sure to back up regularly your important data (including program) files in this instrument to a CD-R or other backup medium. Agilent Technologies shall not be liable for any data damages caused by troubles of this instrument.

### **Making Backup Files**

#### **Making backup files on a floppy disk**

You can make backup files on a floppy disk using the copy function. See “Organizing Files and Folders” on page 172 for making a copy.

#### **Making backup files on the hard disk of an external PC**

You can make backup files on the hard disk of an external PC using following methods.

- You can access to drive D: of the E5061A/E5062A from an external PC via LAN, and copy your important data files on the drive D: to the external PC. See “Accessing Hard Disk of E5061A/E5062A from External PC” on page 227 for details.
- You can transfer your important data files on the drive D: of the E5061A/E5062A to the external PC using :MMEM:TRAN command via GPIB. See *Programmer’s Guide* for details.

---

#### **NOTE**

Do not modify any files and folders in drives other than drive A: and drive D:. Doing so will cause malfunctions.

---

---

## Cleaning this Instrument

This section describes how to clean the instrument.

---

### WARNING

**To protect yourself from electrical shock, be sure to unplug the power cable from the outlet before cleaning the instrument.**

**Never clean the internal components of the instrument.**

---

### Cleaning an LCD

Use one of the following methods to clean the display surface regularly.

- For normal cleaning, rub the surface gently with a dry, soft cloth.
- When stains are difficult to remove, gently wipe the surface with cloth dampened with a small amount of ethanol or isopropyl alcohol.  
You can clean the standard type LCD (no touch screen function) with a cloth dipped in water and then wrung tightly.

---

### NOTE

Do not use chemicals other than ethanol and isopropyl alcohol to wet the cleaning cloth.

To clean a touch screen type LCD (Option 016), do not wet the cloth with water.

---

### Maintenance of Test Ports and Other Connectors/Ports

Test ports on the front panel of the E5061A/E5062A are fitted with N Type connectors (f). Stains or other damage to these connectors would significantly affect the accuracy in measurements in the RF range. Always pay attention to the following precautions.

- Always keep the connectors free from stains and dust.
- Do not touch the contact surface on the connectors.
- Do not plug damaged or scratched connectors into the test ports.
- Use compressed air for cleaning connectors. Do not use abrasives under any circumstance.

The above precautions must also be observed in maintaining connectors and ports other than these test ports.

### Cleaning a Display Other than an LCD

To remove stains on parts other than the LCD, test ports, and other connectors/ports of the instrument, wipe them gently with a soft cloth that is dry or wetted with a small amount of water and wrung tightly.

## Replacement of Parts with Limited Service Life

This instrument incorporates parts with limited service life as shown in Table 13-1. Using the recommended replacement time shown in Table 13-1 as a guide, request the Company's Service Center to replace these parts. However, a part may need to be replaced at an earlier time than that listed in the table, depending on such conditions as location, frequency of use, and where it is stored.

**NOTE** Each service life and recommended replacement time listed below is for reference only and does not imply a guarantee of the part's service life.

**Table 13-1** Parts with Limited Service Life

| Part Name               | Service Life (Parts supplier reference value)  | Recommended replacement time |
|-------------------------|--|------------------------------|
| Hard Disk Drive *1      | 5 years or 20,000 operating hours, whichever comes earlier                           | 3 years                      |
| Floppy disk drive *2    | 5 years or 30,000 operating hours, whichever comes earlier                           | 4 years                      |
| Main fan *2             | 50,000 operating hours   | 5 years                      |
| Power supply *2         | 50,000 operating hours (Depends on the service life of the power supply cooling fan) | 5 years                      |
| LCD screen backlight *3 | 50,000 operating hours   | 5 years                      |
| Touch screen (function) | One million times (dotting life)   | 5 years                      |

\*1. Exchanging hard disk drives causes the contents written after shipment from the factory (LAN setup, etc.) to be initialized to the state at the time of shipment. The programs and data stored in Drive D (user directory) are erased.

\*2. The service life may be significantly shorter when used in a dusty and dirty environment.

\*3. When the unit is used for automatic measurements in a production line and the on-screen information is not required, the life of the LCD backlight can be saved by turning it off. As for the method of turning the backlight off, refer to "Turning off the LCD Screen Backlight" on page 232.

## **Cautions Applicable to Requesting Repair, Replacement, Regular Calibration, etc.**

### **Backing Up Data in the Hard Disk**

The user is requested to back up the stored programs and data into external media by using the instrument's storing function before requesting the Company's Service Center to repair the instrument or replace hard disks.

See "Making Backup Files" on page 286 for how to make backup files.

Please take note that the Company will not be held liable to any extent for potential erasure or change of stored programs or data due to the repair or replacement of hard disks performed by the Company. When a hard disk itself fails, the programs and data stored in it cannot be recovered.

### **Devices to be Sent Back for Repair or Regular Calibration**

If it is necessary to send the unit to the Service Center of Agilent Technologies for repair or regular calibration, please follow the instructions below.

#### **Equipment to be Sent**

When requesting repair or regular calibration of the unit by our Service Center, send only the E5061A/E5062A main unit without any installed option you may have ordered. Unless specifically instructed, it is not necessary to send accessories and calibration kits.

#### **Packing**

Use the original package and shock absorbers, or equivalent antistatic packing materials, when sending the unit.

#### **Shipping Address**

For the location of the nearest Agilent Technologies Service Center, contact the Customer Contact listed at the end of this brochure.

### **Recommended Calibration Period**

The recommended calibration period for this instrument is one year. The user is recommended to request the Company's Service Center to perform regular calibration every year.

Information on Maintenance

**Cautions Applicable to Requesting Repair, Replacement, Regular Calibration, etc.**



---

## **A** **Manual Changes**

This appendix contains the information required to adapt this manual to versions or configurations of the E5061A/E5062A manufactured earlier than the current printing date of this manual. The information in this manual applies directly to E5061A/E5062A units having the serial number printed on the title page of this manual.

---

## Manual Changes

To adapt this manual to your E5061A/E5062A, refer to Table A-1 and Table A-2.

**Table A-1**      **Manual Changes by Serial Number**

| Serial Prefix or Number | Make Manual Changes |
|-------------------------|---------------------|
|                         |                     |

**Table A-2**      **Manual Changes by Firmware Version**

| Version          | Make Manual Changes |
|------------------|---------------------|
| A.02.00 or later | Change 1            |

Agilent Technologies uses a two-part, ten-character serial number that is stamped on the serial number plate (Figure A-1). The first five characters are the serial prefix and the last five digits are the suffix.

**Figure A-1**      **Example of Serial Number Plate**

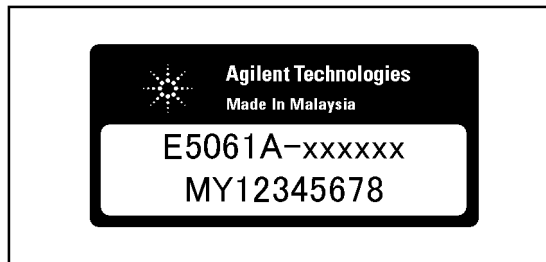

e5061auj2001

## Change 1

The following functions are newly integrated into the firmware version A.02.00 onward. They are not supported by firmware version A.01.0x.

- User preset function.
- Notch search function
- Function to all the marker value are displayed.
- Function to change display position where marker value are displayed.
- Function to align the marker value.
- Display the overlap limit lines.
- Reference tracking function.
- Function to change display value where Y axis are displayed.
- Frequency information appearing as asterisks.
- User recovery function. \*1
- Remote control using HTTP. \*1

---

\*1. This function is available when the volume label on the hard disk is AL200 or higher.

Manual Changes  
**Manual Changes**

---

## **B** Troubleshooting

This Chapter describes the steps to take in troubleshooting when your Agilent E5070B/E5071B appears to be operating improperly. Explanations are also given for the error warning messages displayed on the screen.

## Troubleshooting

This section describes the steps you should take when you believe the Agilent E5070B/E5071B is operating improperly. The results of these simple investigative procedures may help you avoid the down-time and inconvenience of repair service. The troubleshooting instructions are divided into three categories:

- ❑ “Troubleshooting during Startup” on page 296
- ❑ “Troubleshooting during Operation” on page 297
- ❑ “Troubleshooting for External Devices” on page 300

### Troubleshooting during Startup

#### The System Does Not Start Up.

- Turning on (I) the standby switch does not start up the system.
  - Confirm that the power cable is properly plugged in.
  - Confirm that the line switch on the rear panel is turned on (O). For the information on the line switch on the rear panel, see “3. Line Switch (Always ON)” on page 43.

When taking all the above measures does not result in normal operation, there is a possibility of a failure. Unplug the power cable immediately, and contact Agilent Technology’s Customer Contact listed at the end of this guide or the company from which you bought the device.

#### The system starts up, but the normal measurement screen does not appear.

- The system starts up, but it automatically shuts down immediately.
- The system starts up, but it enters the service mode (The instrument status bar in the lower right part of the screen displays **SVC** in red).
- The measurement screen appears after startup, but the date and time displayed on the instrument status bar in the lower right part of the screen differ greatly from the previous settings.
- The measurement screen appears after startup, but the power-on test is failed, with Error Message 241 appearing against a red background in the instrument message/warning area in the lower left part of the screen.
  - Execute the system recovery. For information on the execution procedure, see “System Recovery” on page 236.

There is a possibility of a failure. Contact Agilent Technology’s Customer Contact listed at the end of this guide or the company from which you bought the device.

---

#### NOTE

Occasionally, a few pixels may appear on the screen as a fixed point of blue, green or red. Please note that this is not a failure and does not affect the performance of your product.

## Troubleshooting during Operation

### The Sweep Action Stops during Measurement or Is Not Executed.

- The sweep action stops during measurement or is not executed, but the front keys and softkeys are operational.

There is a possibility of a failure. Contact Agilent Technology’s Customer Contact listed at the end of this guide or the company from which you bought the device.

### The Error Message “Port N receiver overload” (N denotes a port number) is Displayed.

- During the measurement of an amplifier, Error Messages 221 through 222 “Port N receiver overload” (N denotes a port number) on page 306 are displayed. This error occurs when the input to a test port exceeds the maximum input level in the measurement of an amplifier. The measurement value obtained in such a case is not correct. In the worst case, a failure (damage to the receiver) may occur.

- Change the measurement condition so that the input to the test port does not exceed the maximum input level.

When this message is displayed with nothing connected to the test port, there is a possibility of a failure of the instrument. Contact Agilent Technology’s Customer Contact listed at the end of this guide or the company from which you bought the device.

### A Clearly Abnormal Measurement Value

- The measurement value is not reproducible, or clearly abnormal.
  - Confirm that the DUT, connection cables, and other parts are connected correctly.
  - Confirm that the connectors and cables used to connect the DUT are free from damage and poor contact.
  - Confirm that the calibration has been executed correctly. If you have not acquired a correct error correction factor, you cannot obtain a correct measurement value.
  - Confirm that the calibration kit was selected correctly.
  - Confirm that the calibration kit is defined correctly.
  - Confirm that if the stimulus signal output is turned on.

When taking all these measures does not result in a correct measurement value, there is a possibility of a failure. Contact Agilent Technology’s Customer Contact listed at the end of this guide or the company from which you bought the device.

### The System Cannot be Operated Manually (Front Panel Keys, Keyboard, Touch Screen and Mouse)

- The keyboard or mouse becomes inoperable.
  - Confirm that the keyboard or mouse is connected correctly. When it is connected correctly, turn off the power once, and restart the system.
- The front panel key or keyboard becomes inoperable.
  - Using the mouse, turn **System – Mics Setup – Key Lock – Front Panel &**

**Keyboard Lock OFF.**

- The touch screen becomes inoperable.
  - Using the front panel keys, turn **System – Mics Setup – Key Lock – Touch Screen & Mouse Lock OFF**.
  - Execute the calibration of the touch screen. For information on the execution procedure, see “Calibration of the Touch Screen” on page 246.
- The mouse becomes inoperable.
  - Using the front panel keys, turn **System – Mics Setup – Key Lock – Touch Screen & Mouse Lock OFF**.
- All of the front panel keys, keyboard, and mouse become inoperable.
  - Confirm that the keyboard or mouse is connected correctly. When it is connected correctly, turn off the power once, and restart the system.
- The keyboard and mouse have been connected after power-on.
  - Turn off the power once, and restart the system.

When taking all these measures does not recover operability, there is a possibility of a failure. Contact Agilent Technology’s Customer Contact listed at the end of this guide or the company from which you bought the device.

**The Screen Freezes and All Operations Become Impossible.**

- The measurement in progress or screen update is stalled and all of the front panel keys, keyboard, mouse, and touch screen (Option 016) are inoperable.
  - Press the standby switch to turn off the power once, and restart the system.

When a similar symptom reappears, there is a possibility of a failure. Contact Agilent Technology’s Customer Contact listed at the end of this guide or the company from which you bought the device.

**The System Freezes while in Operation.**

- The system freezes while in operation.
  - Press the standby switch to turn off the power once, and restart the system.

**The Rear Cooling Fan Does Not Operate.**

There is a possibility of a failure. Contact Agilent Technology’s Customer Contact listed at the end of this guide or the company from which you bought the device.

**You Cannot Save a File in a Floppy Disk.**

- You cannot save a file in a floppy disk.
  - Confirm that the floppy disk is initialized. If not, initialize it.
  - Confirm that the floppy disk is inserted correctly. Insert a floppy disk until the eject button pops up fully.
  - Confirm that the floppy disk is not write-protected. If it is, unprotect the disk.
  - Confirm that the floppy disk has free space. If it does not, delete unnecessary files or use a new floppy disk.



When taking all these measures does not make it possible to save a file, there is a possibility of a failure. Contact Agilent Technology's Customer Contact listed at the end of this guide or the company from which you bought the device.

### **You Cannot Read a File from a Floppy Disk.**

- You cannot read a file from a floppy disk.
  - Confirm that the floppy disk is inserted correctly. Insert the floppy disk until the eject button pops up fully.
  - A stored file may be damaged by a magnetic field. Confirm that the file can be read on a PC.

When taking all these measures does not make it possible to read the file, there is a possibility of a failure. Contact Agilent Technology's Customer Contact listed at the end of this guide or the company from which you bought the device.

### **An Error or Warning Message Appears.**

When an error or warning message is displayed on the instrument message/warning area in the lower part of the screen, refer to Error Messages on page 301 and Warning Messages on page 310.

## **Troubleshooting for External Devices**

### **Cannot Output to a Printer**

- Cannot output a measurement screen or data to a printer.
- Attempting to output to a printer causes Error Messages 120 and 121 on page 307 to appear.
  - Confirm that the power to the printer is on and that the line cable is connected correctly.
  - Confirm that the connector cable of the printer is connected correctly.
  - Confirm that the printer is online.
  - Confirm that the printer has not run out of paper.
  - Confirm that the printer has not run out of ink.

When taking all these measures does not result in printer output, there is a possibility of a failure. Contact Agilent Technology's Customer Contact listed at the end of this guide or the company from which you bought the device.

### **Does Not Respond to an External Controller/Fails to Function Normally**

- A GPIB device does not respond to the external controller, or fails to function normally.
  - Confirm that the GPIB address is defined correctly.
  - Confirm that the GPIB cable is connected.
  - Confirm that another instrument connected by the GPIB cable has the same GPIB address.
  - Confirm that the GPIB cable connection forms a loop.

When taking all these measures does not result in correct operation of the GPIB devices, there is a possibility of a failure. Contact Agilent Technology's Customer Contact listed at the end of this guide or the company from which you bought the device.

## Error Messages

An error message is displayed against a red background in the instrument message/warning area in the lower left part of the screen. Pushing a front panel key or executing :DISP:CCL command clears the error message. Errors caused by the operation of a front panel key simply appear on the display. They are not stored in the error queue with some exceptions.

An error with a positive error number is one uniquely defined for this instrument. On the other hand, an error with a negative error number is basically one defined for common GPIB devices in IEEE488.2

### A

20

#### **Additional standard needed**

The GPIB command that turns ON the calibration function has been sent before all of the data measurements needed to calculate the calibration factor have been completed. For instance, the “SENS:CORR:COLL:SAVE” command is sent to calculate calibration coefficients and turn on error correction for 1-Port Calibration when open and short calibration are completed but load calibration is not completed. Be sure to measure all necessary calibration data before sending commands. This error is not generated by front key operations.

77

#### **Additional test set calibration needed**

Multiport test set calibration needs to be completed. This error occurs when Slef Cal (SENS:CORR:MULT:SELF:ONCE) is performed without having test set calibration completed.

### B

-168

#### **Block data not allowed**

An block-data element has been received at a position where this instrument does not accept one.

### C

240

#### **Calibration data lost**

This error occurs when a file containing the system calibration data is not found or in a damaged state at time of the startup of this instrument, indicating a failure of this instrument. Contact an Agilent Technology sales office or the company from which you bought the instrument.

22

#### **Calibration method not selected**

This error occurs when the command for validating the calibration, SENS:CORR:COLL:SAVE, is executed before the command for selecting a calibration type, SENS:CORR:COLL:METH:xxxx, is executed. This error is not generated by front key operations.

-148

#### **Character data not allowed**

A character data element (not violating the standard) has been received at a position where this instrument does not accept one. Double quotes (“”) are omitted where it is necessary to

place a parameter in double quotes (“), for example.

-100

**Command error**

A comprehensive syntax error has occurred showing that this instrument cannot detect a more detailed error. This code simply shows that a command error defined in 11.5.1.1.4, IEEE488.2 has occurred.

**D**

-222

**Data out of range**

A data element (not violating the standard) outside the range defined by this instrument has been received. This error occurs when an integer-based command for which the parameter can be rounded exceeds the range of -65536 to +65536 or when a real-number-based command for which the parameter can be rounded exceeds the range of -9.9e37 to +9.9e37, for example.

This error occurs also when a numeric value other than a specified one is entered into a command in which the “port number” and “CalKit number” are specified as parameters and hence the parameters are not rounded. Such commands are, for example, SENS:CORR:COLL:ACQ:OPEN, SENS:CORR:COLL:ECAL:SOLT1, SENS:CORR:COLL:CKIT:ORD:LOAD, etc.

-104

**Data type error**

The parser has recognized a data element that must not exist. Block data has been sent instead of numeric value data or character string data that had been expected, for example.

**E**

32

**Ecal module not in appropriate RF path**

This error occurs when an ECal command, SENS:CORR:COLL:ECAL:SOLTn, is executed with the port on the ECal module not connected correctly to the instrument.

-200

**Execution error**

An error associated with execution has been generated for which this instrument cannot specify the error message. This code shows that an error associated with execution defined in 11.5.1.1.5, IEEE488.2 has occurred. This error occurs also when a calibration measurement is aborted.

-123

**Exponent too large**

The absolute value of the exponent exceeds 32,000 (see 7.7.2.4.1, IEEE488.2).

-178

**Expression data not allowed**

An expression-data element has been received at a position where this instrument does not accept one.

-170

**Expression error**

When the expression data is put to syntactic analysis, an error not corresponding to one of Error Numbers -171 through -179 occurs.

**F**

31

**Failed to configure ECal module**

- This error occurs when the control of the ECal module fails at time of executing an ECal command, SENS:CORR:COLL:ECAL:SOLTn. The failure results from the failure to connect the ECal module to the USB port, failure of the ECal module, etc.
- 76           **Failed to configure multipoint test set**
- This error occurs when multipoint test set control is enabled (SENS:MULT ON) and the analyzer fails to control the test set. Make sure the analyzer and the test set are connected with the parallel cable, and the test set is powered on.
- 102           **Failed to copy file**
- This error occurs when copying a file (MMEM:COPY command) fails.
- 104           **Failed to create directory**
- This error occurs when creating a directory (MMEM:MDIR command) fails.
- 103           **Failed to delete file**
- This error occurs when deleting a file (MMEM:DEL command) fails.
- 100           **Failed to read file**
- This error occurs when a 2-port touchstone file (CALC:FSIM:SEND:PMC:PORT:USER:FIL command), the formatted data array (MMEM:LOAD:FDAT command) and limit table (MMEM:STOR:LIM command) for the active trace on the active channel, segment sweep table (MMEM:LOAD:SEGM command) for the active channel, a VBA project file (MMEM:LOAD:PROG command), etc. cannot be read normally.
- 101           **Failed to write file**
- This error occurs when the formatted data array (MMEM:STOR:FDATcommand) and limit table (MMEM:STOR:LIM command) for the active trace on the active channel, segment sweep table (MMEM:STOR:SEGM command) for the active channel, display image (MMEM:STOR:IMAG command) for the LCD screen, a VBA project file (MMEM:STOR:PROG command), etc. cannot be written normally.
- 54           **Fault location not allowed**
- This error occurs when the fault location function is enabled when the sweep type is not set to linear or the number of measurement points is two. The fault location function is available only when linear sweep with more than two measurement points.
- 257           **File name error**
- A file name error. This message appears when an error exists in the file name and hence a command is not executed correctly. This error occurs when you try to copy to an unsuitable file name, for example.
- 256           **File name not found**
- The file name specified is not found and hence the command is not executed correctly. This error occurs when you try to read a file that does not exist in a disk or a disk is not correctly inserted into the drive to read or write a file, for example.
- 107           **File transfer failed**
- This error occurs when writing data into or reading data from a file (MMEM:TRAN command) fails.

## G

-105 **GET not allowed**

A group execution trigger (GET) has been received in the program message (see 7.7, IEEE488.2).

## H

-114 **Header suffix out of range**

The unit of the header is outside the range. The header is invalid in the unit for numeric parameters following a SCPI command.

## I

-224 **Illegal parameter value**

The parameter value is not suitable. This error occurs when the CALC:PAR:DEF command is used to specify an S-parameter that does not exist in the model.

-282 **Illegal program name**

This error occurs when a nonexistent VBA program name is specified by the PROG:SEL:NAME command.

-213 **Init ignored**

Because another measurement is in progress, the request for initiating a measurement (“INIT” command) is ignored.

-161 **Invalid block data**

Block data has been expected, but the block data that appears is invalid for some reason (see 7.7.6.2, IEEE488.2). The END message is received before the length of block data has been filled, for example.

-101 **Invalid character**

An invalid character exists in the program message character string.

-141 **Invalid character data**

An invalid character is found in the character data element, or the parameter received is not valid.

-121 **Invalid character in number**

A character that is invalid for the data type subject to syntactic analysis has been received. For example, a letter is found in a decimal numeric value or a numeric character “9” in octal data.

-171 **Invalid expression**

The expression-data element is invalid (see 7.7.7.2, IEEE488.2). Parentheses are not paired, or illegal characters are used, for example.

-103 **Invalid separator**

The parser (a syntactic analysis program) had been expecting a delimiter, but a character that is not a delimiter has been sent.

-151 **Invalid string data**

- Character string data has been expected, but the character string data that appears is invalid for some reason (see 7.7.5.2, IEEE488.2). The END message is received before the ending quotation mark character appears, for example.
- 131      **Invalid suffix**
- The suffix does not comply with the syntax defined in 7.7.3.2, IEEE488.2. Or it does not suit 4294A.
- L**
- 53      **Log sweep requires 2 octave minimum span**
- The span of sweep range is not satisfied the requirement for logarithmic sweep. The sweep type is automatically changed to linear sweep when this error occurs.
- For example, this error occurs when, with the start and stop frequency are set 1 MHz and 2 MHz respectively, the sweep type is changed to logarithmic sweep.
- Set the stop frequency to more than four times as many as the start frequency. And then select logarithmic sweep.
- M**
- 109      **Missing parameter**
- The number of parameters is less than that required for the command, or the parameter has not been entered. For example, the command SENS{1-4}:SWE:POIN requires one more parameter.
- Therefore, when a message “SENS1:SWE:POIN” is sent to a correct program message “SENS1:SWE:POIN 201” this instrument receives the former message as an invalid one because all parameters have not been entered. Enter command parameters correctly.
- 75      **Multiport test set not enabled**
- This error occurs when multiport test set calibration is performed while test set control is not enabled.
- N**
- 56      **Not enough points for connector model**
- This error occurs when the connector measurement function of the SRL measurement is performed with the number of measurement points less than 101. Use at least 101 points.
- 52      **No valid memory trace**
- This error occurs when there is no valide memory trace data and :DISP:WIND:TRAC:MEM ON or DISP:WIND:TRAC:STAT ON is received or parameters other than “NORM” is set with CALC:MATH:FUNC.
- 120      **Numeric data error**
- An error resulting from the numeric value data (including numeric value data having no decimal point representation) has occurred. A numeric value error other than Errors -121 through -129 has occurred.
- 128      **Numeric data not allowed**

## Troubleshooting

### Error Messages

An numeric-value-data element (not violating the standard) has been received at a position where this instrument does not accept one.

## O

### 200 **Option not installed**

The command received has been ignored because of the mismatch between the contents of an option for this instrument and the command.

For example, this error occurs when the source attenuator (power range) is set at a value other than zero (SOUR:POW:ATT command) in a model not having the extended power output option.

This error is not generated by front key operations.

### -225 **Out of memory**

Insufficient memory is available in this instrument to perform the required operation.

## P

### -220 **Parameter error**

When a parameter-related error other than Errors -221 through -229 occurs, that error is displayed.

### -108 **Parameter not allowed**

The number of parameters exceeds that required for the command.

For instance, when a program message “:SENS1:SWE:TYPE LIN, SEGM” is sent instead of a correct program message with a command “:SENS1:SWE:TYPE LIN” which requires a parameter, the instrument receives the message as the number of parameters is invalid. See the command reference to confirm the required number of parameters.

### 41 **Peak not found**

This error occurs when, after specifying a peak and executing the CALC:MARK:FUNC:EXEC and CALC:FUNC:EXEC commands, the specified peak is not found in the marker search analysis.

### 220 **Phase lock loop unlocked**

This error occurs when the PLL circuit of this instrument becomes unlocked while the measurement is in progress. The measurement value is not correct. This error may occur when an external reference out of specification is connected to this instrument. Should an error occur with an external reference not connected, this instrument is faulty. Contact an Agilent Technology sales office or the company from which you bought the instrument.

### 221 **Port 1 receiver overload**

The input to Test Port 1 exceeds the maximum input level. The measurement value is not correct. When a DUT is an amplifier or the like, this error may occur, damaging the receiver in the worst case. Should this error occur with a passive part used as the DUT or with nothing connected to the test port, this instrument is faulty. Contact an Agilent Technology sales office or the company from which you bought the instrument.

If this error occurs, the stimulus signal output is automatically turned to off.

### 222 **Port 2 receiver overload**



The input to Test Port 2 exceeds the maximum input level. The measurement value is not correct. When a DUT is an amplifier or the like, this error may occur, damaging the receiver in the worst case. Should this error occur with a passive part used as the DUT or with nothing connected to the test port, this instrument is faulty. Contact an Agilent Technology sales office or the company from which you bought the instrument.

If this error occurs, the stimulus signal output is automatically turned to off.

241 **Power on test failed**

This error occurs when the power-on test fails, indicating a failure of this instrument. Contact an Agilent Technology sales office or the company from which you bought the instrument.

61 **Power unlevelled**

The out power level exceeds available range.

For example, if the level after correction exceeds the power level that can be outputted when correcting the power level with the power slope feature, this error occurs.

Check that the power level is set correctly, and the correction value of the power slope is set correctly.

120 **Printer error**

This error occurs when the previous printing is still in progress or the printer fails (offline, short of paper, etc.) at time of outputting the display image on the LCD screen to the printer (HCOP:IMM command).

121 **Print failed**

This error occurs when printing fails for reasons other than Error 120, Printer error.

-284 **Program currently running**

This error occurs when the PROG:SEL:STAT RUN command is executed with the VBA program in the Run state.

-112 **Program mnemonic too long**

The length of the header exceeds 12 characters (see 7.6.1.4.1, IEEE488.2).

-286 **Program runtime error**

An error occurring when VBA is executed.

**Q**

-430 **Query DEADLOCKED**

The state that generates a “DEADLOCKED” Query error (see 6.3.1.7, IEEE488.2). This error occurs when both input and output buffers have become full, preventing the instrument from continuing processing, for example.

-400 **Query error**

A comprehensive query error has occurred showing that this instrument cannot detect a more detailed error. This code simply shows that a query error defined in 11.5.1.1.7 and 6.3, IEEE488.2 has occurred.

-410 **Query INTERRUPTED**

The state that generates a “INTERRUPTED” Query error (see 6.3.2.3, IEEE488.1). This

## Troubleshooting

### Error Messages

error occurs when data bytes (DAB) or GET are received before the transmission of the response after a query has not been completed, for example.

-420

#### **Query UNTERMINATED**

The state that generates an “UNTERMINATED” Query error (see 6.3.2, IEEE488.2). This error occurs when this instrument is designated as the talker and an incomplete program message is received, for example.

-440

#### **Query UNTERMINATED after indefinite response**

After a query asking for an indefinite response has been run, another query is received in the same program message (See 6.5.7.5.7, IEEE488.2).

## **R**

105

#### **Recall failed**

This error occurs when reading an instrument status file (State01.sta, etc.) (MMEM:LOAD:STAT command) fails.

## **S**

106

#### **Save failed**

This error occurs when writing an instrument status file (State01.sta, etc.) (MMEM:STOR:STAT command) fails.

50

#### **Specified channel hidden**

This error occurs when an attempt is made to activate a channel not on display using the DISP:WIND:ACT command. This error is not generated by front key operations.

23

#### **Specified error term dose not exist**

21

#### **Specified ports overlapped**

This error occurs when a port number is duplicated in a command requiring two or more port numbers as parameters. Specify port setup correctly to avoid duplication of ports. This error is not generated by front key operations.

51

#### **Specified trace dose not exist**

-150

#### **String data error**

When a character-string-data element is put to syntactic analysis, an error not corresponding to one of Error Numbers -151 through -159 occurs.

-158

#### **String data not allowed**

A character-string-data element has been received at a position where this instrument does not accept one.

-138

#### **Suffix not allowed**

A suffix is attached to a numeric value element to which a suffix is not allowed to be attached.

-134

#### **Suffix too long**

|      |  |
|------|--|
|      | The unit is too long.  |
|      | The unit is expressed in 12 or more characters (see 7.7.3.4, IEEE488.2).   |
| -102 | <b>Syntax error</b>  |
|      | A command or data type that is not recognized exists.  |
| -310 | <b>System error</b>  |
|      | One of the errors designated as “system errors” in this instrument has occurred.   |
|      | <b>T</b>   |
| 40   | <b>Target value not found</b>  |
|      | This error occurs when the target is not found during the marker search analysis after specifying the target and executing the CALC:MARK:FUNC:EXEC and CALC:FUNC:EXEC commands. This error occurs also when the bandwidth is not found after executing the bandwidth marker command, CALC:MARK:BWID:DATA?  |
| -124 | <b>Too many digits</b>   |
|      | The number of digits of the argument of the decimal numeric-value-data element exceeds 255 with the preceding 0 removed (see 7.7.2.4.1, IEEE488.2).  |
| -223 | <b>Too much data</b>   |
|      | The block-, expression-, or character-string-type program data that has been received conforms with the standard. But it exceeds the amount that can be processed under the condition of the memory or conditions specific to memory-related devices. In this instrument, this error occurs when the number of characters exceeds 254 in a character-string parameter. |
| -211 | <b>Trigger ignored</b>   |
|      | This instrument receives and detects a trigger command (“TRIG”) or an external trigger signal. But it is ignored due to the timing condition (This instrument is not in the wait-for-trigger state, for example). Change the setup so that a trigger command or an external trigger signal can be sent after the instrument has entered the wait-for-trigger state.    |
|      | <b>U</b>   |
| -113 | <b>Undefined header</b>  |
|      | A command not defined in this instrument, though not illegal in the syntactic structure, has been received. For example, when a message “:DISP:WIND1:TABL:MEM ON” is sent to a correct program message “:DISP:WIND1:TRAC1:MEM ON,” the message sent is received as an undefined command by this instrument. See the command reference and use correct commands.        |
|      | This error occurs also when a port not existing on this model is specified in a command specifying a port number as an index. Such commands are CALC:FSIM:SEND:DEEM:PORTn:xxxx, CALC:FSIM:SEND:PMC:PORTn:xxxx, CALC:FSIM:SEND:ZCON:PORTn:Z0:R, and SENS:CORR:EXT:PORTn:TIME; they include PORTn as a part.   |

## Warning Message

A warning message is displayed in the instrument message/Warning area in the lower left part of the display against a gray background. Pushing a front panel key or executing :DISP:CCL command clears the message.

This message simply appears on the display, being not known to a remote environment such as a GPIB. This message is not displayed when another error (against a red background) has already been displayed in the instrument message/Warning area.

The warning messages for this instrument are as follows:

### **Cable Z out of range**

This error occurs in SRL measurement function when measured average impedance is out of the tolerance (system impedance +/- 30%), and the SRL calculation is not valid.

### **Fault location not allowed**

This warning message is displayed when the gating/transform function of time domain function is turned on, number of points is set 2 or sweep type is set logarithmic/segment sweep.

The gating function and transform function are automatically turned off when this warning message is displayed.

### **Log sweep requires 2 octave minimum span**

If you change the sweep range that does not satisfy the necessary condition of the frequency span (the stop frequency is about 4 times or more of the start frequency) when the sweep type is set to the log sweep, this message is displayed.

If this message is displayed, the sweep type is automatically set to the linear sweep.

For example, if you attempt to change the log type to the log sweep when the start frequency is set to 1 MHz and the stop frequency to 2 MHz, this error occurs.

Set the stop frequency to a value of about 4 times or more the start frequency and then set the low sweep.

### **Peak not found**

This warning message is displayed when, with the tracking turned on, the peak specified by the marker search has not been found by the time the sweep is finished (with the tracking executed).

### **Segment table changed**

This warning message is displayed when the setting specified segment by segment in the segment table is automatically changed by a change in the other setting.

For example, this warning message is displayed when, with the power specified segment by segment in the segment table, the power setting for a segment is adjusted by a change in the power range setting.

### **Target value not found**

This warning message is displayed when, with the tracking turned on, the target specified by the marker search has not been found by the time the sweep is finished (with the tracking executed).

This warning message is displayed also when, with the bandwidth marker displayed, the setting for the bandwidth marker is changed at the end of the sweep, or when, with the

active marker changed or moved, the bandwidth is not found.

#### **User Preset File not found**

This warning message is displayed if no user preset file (D:\UserPreset.sta) exists when executing the SYST:UPR command.

If this message is displayed, a normal preset (SYST:PRES) will be performed.

For details on setting the user preset function, see “Setting the user preset function” on page 234.



---

## **C** **List of Default Values**

This appendix gives the default values, settings for Save/Recall of an object, and settings for backing up an object when using the Agilent E5061A/E5062A.

---

## List of Default Values, Save/Recall Settings, and Backup Settings

The table below shows the following settings for the Agilent E5061A/E5062A.

- Factory-shipped settings
- Settings valid when you press **Preset** (Or when you execute the **:SYST:PRES** command)
- Settings valid when you execute the **\*RST** command
- Settings that permit Save/Recall of a setup state

In the table, states that can be saved/recalled are denoted in the following manner:

√: Save/Recall can be performed

Blank: Save/Recall cannot be performed

- Settings that are backed up (set state not affected by turning power ON/OFF)

In the table, a setting that is automatically backed up is denoted in the following manner:

√: Backup operation performed

Blank: Backup operation not performed

- Available means of defining a setting

In the table, the following symbols are used to denote the method(s) that can be used to define a setting.

K: Using the front panel key (including the mouse and keyboard)

C: Using the SCPI command or COM object

---

### NOTE

In the table, the ← symbol shows that the setup is the same as that in the box to the left.



List of Default Values

List of Default Values, Save/Recall Settings, and Backup Settings

| Key Operation      | Factory-shipped Setting | Default Value |      | Save/Recall | Backup | Available Means of Defining a Setting |
|--------------------|-------------------------|---------------|------|-------------|--------|---------------------------------------|
|                    |                         | Preset        | *RST |             |        |                                       |
| Meas               | S11                     | ←             | ←    | √           |        | K/C                                   |
| Format             | Log Mag                 | ←             | ←    | √           |        | K/C                                   |
| Scale              |                         |               |      |             |        |                                       |
| Divisions          | 10                      | ←             | ←    | √           |        | K/C                                   |
| Scale/Div          | 10.000 dB/div           | ←             | ←    | √           |        | K/C                                   |
| Reference Position | 5 Div                   | ←             | ←    | √           |        | K/C                                   |
| Reference Value    | 0.0000 dB               | ←             | ←    | √           |        | K/C                                   |
| Reference Tracking |                         |               |      |             |        |                                       |
| Tracking           | OFF                     | ←             | ←    | √           |        | K/C                                   |
| Track Frequency    | 0                       | ←             | ←    | √           |        | K/C                                   |
| Electrical Delay   | 0.0000 s                | ←             | ←    | √           |        | K/C                                   |
| Phase Offset       | 0.0000 °                | ←             | ←    | √           |        | K/C                                   |
| Display            |                         |               |      |             |        |                                       |
| Allocate Channels  | ×1 <input type="text"/> | ←             | ←    | √           |        | K/C                                   |
| Number of Traces   | 1                       | ←             | ←    | √           |        | K/C                                   |
| Allocate Traces    | ×1 <input type="text"/> | ←             | ←    | √           |        | K/C                                   |
| Display            | Data                    | ←             | ←    | √           |        | K/C                                   |
| Data Math          | OFF                     | ←             | ←    | √           |        | K/C                                   |
| Title Label        | OFF                     | ←             | ←    | √           |        | K/C                                   |
| Graticule Label    | ON                      | ←             | ←    | √           |        | K/C                                   |
| Graticule Label    | AUTO                    | ←             | ←    | √           |        | K/C                                   |
| Invert Color       | OFF                     | ←             | ←    | √           |        | K/C                                   |
| Frequency          | ON                      | ←             | ←    | √           |        | K/C                                   |
| Update             | ON                      | ←             | ←    | √           |        | K/C                                   |
| Avg                |                         |               |      |             |        |                                       |
| Avg Factor         | 16                      | ←             | ←    | √           |        | K/C                                   |
| Averaging          | OFF                     | ←             | ←    | √           |        | K/C                                   |
| SMO Aperture       | 1.5000%                 | ←             | ←    | √           |        | K/C                                   |
| Smoothing          | OFF                     | ←             | ←    | √           |        | K/C                                   |
| IF Bandwidth       | 30 kHz                  | ←             | ←    | √           |        | K/C                                   |
| Cal                |                         |               |      |             |        |                                       |
| Correction         | OFF                     | ←             | ←    | √           |        | K/C                                   |
| Calibrate          |                         |               |      |             |        |                                       |
| Response (Open)    |                         |               |      |             |        |                                       |
| Port               | 1                       | ←             | ←    |             |        | K/C                                   |
| Response (Short)   |                         |               |      |             |        |                                       |
| Port               | 1                       | ←             | ←    |             |        | K/C                                   |

List of Default Values

List of Default Values, Save/Recall Settings, and Backup Settings

| Key Operation     | Factory-shipped Setting                          | Default Value |      | Save/<br>Recall | Backup | Available<br>Means of<br>Defining a<br>Setting |
|-------------------|--|---------------|------|-----------------|--------|--|
|                   |  | Preset        | *RST |                 |        |  |
| Cal               |  |               |      |                 |        |  |
| Calibrate         |  |               |      |                 |        |  |
| Response (Thru)   |  |               |      |                 |        |  |
| Ports             | 2-1 (S21)  | ←             | ←    |                 |        | K/C  |
| Enhanced Response |  |               |      |                 |        |  |
| Ports             | 2-1 (S21 S11)                                    | ←             | ←    |                 |        | K/C  |
| 1-Port Cal        |  |               |      |                 |        |  |
| Port              | 1  | ←             | ←    |                 |        | K/C  |
| ECal              |  |               |      |                 |        |  |
| Isolation         | OFF  | ←             | ←    | √               |        | K/C  |
| Property          | OFF  | ←             | ←    | √               |        | K/C  |
| Cal Kit           | 85032B/E (Opt.150/250)<br>85036B/E (Opt.175/275) | ←             | ←    | √               |        | K/C  |
| Modify Cal Kit    |  |               |      |                 |        |  |
| Define STDs       | Define STDs                                      | ←             | ←    | √               |        | K  |
| Specify CLSs      |  |               |      |                 |        |  |
| Open              | Open   | ←             | ←    | √               |        | K  |
| Port Extensions   |  |               |      |                 |        |  |
| Extension Port1   | OFF  | ←             | ←    | √               |        | K/C  |
| Extension Port2   | OFF  | ←             | ←    | √               |        | K/C  |
| Velocity Factor   | 1.0000   | ←             | ←    | √               |        | K/C  |
| Set Z0            | 50 Ω or 75 Ω                                     | ←             | ←    | √               |        | K/C  |
| Start             | 300.00 kHz                                       | ←             | ←    | √               |        | K/C  |
| Stop              | 1.5000 GHz (E5061A)<br>3.0000 GHz (E5062A)       | ←             | ←    | √               |        | K/C  |
| Center            | 750.15 MHz (E5061A)<br>1.50015 GHz (E5062A)      | ←             | ←    | √               |        | K/C  |
| Span              | 1.4997 GHz (E5061A)<br>2.9997 GHz (E5062A)       | ←             | ←    | √               |        | K/C  |
| Sweep Setup       |  |               |      |                 |        |  |
| Power             |  |               |      |                 |        |  |
| Power             | 0 dBm  | ←             | ←    | √               |        | K/C  |
| Power Ranges      | -5 to 10   | ←             | ←    | √               |        | K/C  |
| Port Couple       | ON   | ←             | ←    | √               |        | K/C  |
| Port Power        |  |               |      |                 |        |  |
| Port 1 Power      | 0 dBm  | ←             | ←    | √               |        | K/C  |
| Port 2 Power      | 0 dBm  | ←             | ←    | √               |        | K/C  |
| Slope [xx dB/GHz] | 0 dB/GHz   | ←             | ←    | √               |        | K/C  |
| Slope [ON/OFF]    | OFF  | ←             | ←    | √               |        | K/C  |

List of Default Values  
List of Default Values, Save/Recall Settings, and Backup Settings

| Key Operation             | Factory-shipped Setting   | Default Value |                        | Save/<br>Recall | Backup | Available<br>Means of<br>Defining a<br>Setting |
|---------------------------|---|---------------|------------------------|-----------------|--------|--|
|                           |   | Preset        | *RST                   |                 |        |  |
| <b>Sweep Setup</b>        |   |               |                        |                 |        |  |
| <b>Power</b>              |   |               |                        |                 |        |  |
| CW Freq                   | 300.00 kHz  | ←             | ←                      | √               |        | K/C  |
| RF Out                    | ON  | ←             | ←                      | √               |        | K/C  |
| Sweep Time                | AUTO  | ←             | ←                      | √               |        | K/C  |
| Sweep Delay               | 0.0000 s  | ←             | ←                      | √               |        | K/C  |
| Points                    | 201   | ←             | ←                      | √               |        | K/C  |
| Sweep Type                | Linear  | ←             | ←                      | √               |        | K/C  |
| <b>Edit Segment Table</b> |   |               |                        |                 |        |  |
| Freq Mode                 | Start/Stop  | ←             | ←                      | √               |        | K/C  |
| List IFBW                 | OFF   | ←             | ←                      | √               |        | K/C  |
| List Power                | OFF   | ←             | ←                      | √               |        | K/C  |
| List Delay                | OFF   | ←             | ←                      | √               |        | K/C  |
| List Time                 | OFF   | ←             | ←                      | √               |        | K/C  |
| Segment Display           | Order Base  | ←             | ←                      | √               |        | K/C  |
| <b>Trigger</b>            |   |               |                        |                 |        |  |
| Continuous                | Continuous (Ch1)<br>Hold (Ch2 to 4)   | ←             | Hold<br>(all channels) | √               |        | K/C  |
| Trigger Source            | Internal  | ←             | ←                      | √               |        | K/C  |
| <b>Marker</b>             |   |               |                        |                 |        |  |
| Marker 1                  | Marker 1 is turned on immediately<br>after the marker softkey menu is<br>displayed. | ←             | ←                      | √               |        | K/C  |
| Ref Marker Mode           | OFF   | ←             | ←                      | √               |        | K/C  |
| <b>Marker Search</b>      |   |               |                        |                 |        |  |
| <b>Peak</b>               |   |               |                        |                 |        |  |
| Peak Excursion            | 3.0000 dB   | ←             | ←                      | √               |        | K/C  |
| Peak Polarity             | Positive  | ←             | ←                      | √               |        | K/C  |
| <b>Target</b>             |   |               |                        |                 |        |  |
| Target Value              | 0.0000 dB<br>(When Target is selected)  | ←             | ←                      | √               |        | K/C  |
| Target Transition         | Both<br>(When Target is selected)   | ←             | ←                      | √               |        | K/C  |
| <b>Multi Peak</b>         |   |               |                        |                 |        |  |
| Peak Excursion            | 3.0000 dB   | ←             | ←                      | √               |        | K/C  |
| Peak Polarity             | Positive  | ←             | ←                      | √               |        | K/C  |
| <b>Multi Target</b>       |   |               |                        |                 |        |  |
| Target Value              | 0.0000 dB   | ←             | ←                      | √               |        | K/C  |
| Target Transition         | Both  | ←             | ←                      | √               |        | K/C  |
| Tracking                  | OFF   | ←             | ←                      | √               |        | K/C  |

List of Default Values

List of Default Values, Save/Recall Settings, and Backup Settings

| Key Operation             | Factory-shipped Setting                      | Default Value |      | Save/<br>Recall | Backup | Available<br>Means of<br>Defining a<br>Setting |
|---------------------------|--|---------------|------|-----------------|--------|--|
|                           |  | Preset        | *RST |                 |        |  |
| <b>Marker Search</b>      |  |               |      |                 |        |  |
| <b>Search Range</b>       |  |               |      |                 |        |  |
| Search Range              | OFF  | ←             | ←    | √               |        | K/C  |
| Start                     | 0.0000 Hz                                    | ←             | ←    | √               |        | K/C  |
| Stop                      | 0.0000 Hz                                    | ←             | ←    | √               |        | K/C  |
| Couple                    | ON   | ←             | ←    | √               |        | K/C  |
| Bandwidth                 | OFF  | ←             | ←    | √               |        | K/C  |
| Bandwidth Value           | -3.0000 dB<br>(When one of the marker is on) | ←             | ←    | √               |        | K/C  |
| Notch                     | OFF  | ←             | ←    | √               |        | K/C  |
| Notch Value               | -3.0000 dB<br>(When one of the marker is on) | ←             | ←    | √               |        | K/C  |
| <b>Marker Fctn</b>        |  |               |      |                 |        |  |
| Discrete                  | OFF  | ←             | ←    | √               |        | K/C  |
| Couple                    | ON   | ←             | ←    | √               |        | K/C  |
| Marker Table              | OFF  | ←             | ←    | √               |        | K/C  |
| Statistics                | OFF  | ←             | ←    | √               |        | K/C  |
| Flatness                  | OFF  | ←             | ←    | √               |        | K/C  |
| RF Filter Stats           | OFF  | ←             | ←    | √               |        | K/C  |
| <b>Annotation Options</b> |  |               |      |                 |        |  |
| Marker Info X Pos         | 1 %  | ←             | ←    | √               |        | K/C  |
| Marker Info Y Pos         | 1 %  | ←             | ←    | √               |        | K/C  |
| Align                     | ON   | ←             | ←    | √               |        | K/C  |
| Active Only               | ON   | ←             | ←    | √               |        | K/C  |
| <b>Analysis</b>           |  |               |      |                 |        |  |
| <b>Conversion</b>         |  |               |      |                 |        |  |
| Conversion                | OFF  | ←             | ←    | √               |        | K/C  |
| Function                  | Z:Reflection                                 | ←             | ←    | √               |        | K/C  |
| <b>Limit Test</b>         |  |               |      |                 |        |  |
| Clip Lines                | ON   | ←             | ←    | √               |        | K/C  |
| Limit Test                | OFF  | ←             | ←    | √               |        | K/C  |
| Limit Line                | OFF  | ←             | ←    | √               |        | K/C  |
| Fail Sign                 | ON   | ←             | ←    | √               |        | K/C  |
| <b>Macro Setup</b>        |  |               |      |                 |        |  |
| Echo Window               | OFF  | ←             | ←    | √               |        | K/C  |
| <b>Save/Recall</b>        |  |               |      |                 |        |  |
| Save Type                 | State&Cal                                    | ←             | ←    | √               |        | K/C  |
| Channel/Trace             | Disp Only                                    | ←             | ←    | √               |        | K/C  |

List of Default Values  
**List of Default Values, Save/Recall Settings, and Backup Settings**

| Key Operation               | Factory-shipped Setting | Default Value |      | Save/<br>Recall | Backup | Available<br>Means of<br>Defining a<br>Setting |
|-----------------------------|-------------------------|---------------|------|-----------------|--------|--|
|                             |                         | Preset        | *RST |                 |        |  |
| <b>System</b>               |                         |               |      |                 |        |  |
| Invert Image                | ON                      | ←             | ←    | √               |        | K/C  |
| <b>87050/75 Control</b>     |                         |               |      |                 |        |  |
| Reflection                  | Port1                   | ←             | ←    | √               |        | K/C  |
| Transmission                | Port2                   | ←             | ←    | √               |        | K/C  |
| Property                    | ON                      | ←             | ←    | √               |        | K/C  |
| <b>Misc Setup</b>           |                         |               |      |                 |        |  |
| <b>Beeper</b>               |                         |               |      |                 |        |  |
| Beep Complete               | ON                      | ←             | ←    | √               |        | K/C  |
| Beep Warning                | ON                      | ←             | ←    | √               |        | K/C  |
| <b>GPIB Setup</b>           |                         |               |      |                 |        |  |
| Talker/Listener Address     | 17                      | Non-changing  | ←    |                 | √      | K  |
| <b>Network Setup</b>        |                         |               |      |                 |        |  |
| Telnet Server               | OFF                     | Non-changing  | ←    |                 | √      | K  |
| SICL-LAN Server             | OFF                     | Non-changing  | ←    |                 | √      | K  |
| SICL-LAN Address            | 17                      | Non-changing  | ←    |                 | √      | K  |
| Network Device              | ENABLE                  | Non-changing  | ←    |                 | √      | K  |
| <b>Clock Setup</b>          |                         |               |      |                 |        |  |
| Show Clock                  | ON                      | ←             | ←    | √               |        | K/C  |
| <b>Key Lock</b>             |                         |               |      |                 |        |  |
| Front Panel & Keyboard Lock | OFF                     | ←             | ←    |                 |        | K/C  |
| Touch Screen & Mouse Lock   | OFF                     | ←             | ←    |                 |        | K/C  |
| <b>Color Setup</b>          |                         |               |      |                 |        |  |
| <b>Normal</b>               |                         |               |      |                 |        |  |
| Data Trace 1                | Red:5 Green:5 Blue:0    | ←             | ←    | √               |        | K/C  |
| Data Trace 2                | Red:0 Green:5 Blue:5    | ←             | ←    | √               |        | K/C  |
| Data Trace 3                | Red:5 Green:0 Blue:5    | ←             | ←    | √               |        | K/C  |
| Data Trace 4                | Red:0 Green:5 Blue:0    | ←             | ←    | √               |        | K/C  |
| Mem Trace 1                 | Red:3 Green:3 Blue:0    | ←             | ←    | √               |        | K/C  |
| Mem Trace 2                 | Red:0 Green:3 Blue:3    | ←             | ←    | √               |        | K/C  |
| Mem Trace 3                 | Red:3 Green:0 Blue:3    | ←             | ←    | √               |        | K/C  |
| Mem Trace 4                 | Red:0 Green:3 Blue:0    | ←             | ←    | √               |        | K/C  |
| Graticule Main              | Red:3 Green:3 Blue:3    | ←             | ←    | √               |        | K/C  |
| Graticule Sub               | Red:1 Green:1 Blue:1    | ←             | ←    | √               |        | K/C  |
| Limit Fail                  | Red:5 Green:0 Blue:0    | ←             | ←    | √               |        | K/C  |
| Limit Line                  | Red:3 Green:0 Blue:0    | ←             | ←    | √               |        | K/C  |

List of Default Values

List of Default Values, Save/Recall Settings, and Backup Settings

| Key Operation     | Factory-shipped Setting | Default Value |      | Save/<br>Recall | Backup | Available<br>Means of<br>Defining a<br>Setting |
|-------------------|-------------------------|---------------|------|-----------------|--------|--|
|                   |                         | Preset        | *RST |                 |        |  |
| System            |                         |               |      |                 |        |  |
| Misc Setup        |                         |               |      |                 |        |  |
| Color Setup       |                         |               |      |                 |        |  |
| Normal            |                         |               |      |                 |        |  |
| Background        | Red:0 Green:0 Blue:0    | ←             | ←    | √               |        | K/C  |
| Invert            |                         |               |      |                 |        |  |
| Data Trace 1      | Red:0 Green:0 Blue:3    | ←             | ←    | √               |        | K/C  |
| Data Trace 2      | Red:3 Green:0 Blue:0    | ←             | ←    | √               |        | K/C  |
| Data Trace 3      | Red:0 Green:3 Blue:0    | ←             | ←    | √               |        | K/C  |
| Data Trace 4      | Red:3 Green:0 Blue:3    | ←             | ←    | √               |        | K/C  |
| Mem Trace 1       | Red:2 Green:2 Blue:5    | ←             | ←    | √               |        | K/C  |
| Mem Trace 2       | Red:5 Green:2 Blue:2    | ←             | ←    | √               |        | K/C  |
| Mem Trace 3       | Red:2 Green:5 Blue:2    | ←             | ←    | √               |        | K/C  |
| Mem Trace 4       | Red:5 Green:2 Blue:5    | ←             | ←    | √               |        | K/C  |
| Graticule<br>Main | Red:2 Green:2 Blue:2    | ←             | ←    | √               |        | K/C  |
| Graticule<br>Sub  | Red:4 Green:4 Blue:4    | ←             | ←    | √               |        | K/C  |
| Limit Fail        | Red:5 Green:0 Blue:0    | ←             | ←    | √               |        | K/C  |
| Limit Line        | Red:3 Green:0 Blue:0    | ←             | ←    | √               |        | K/C  |
| Background        | Red:5 Green:5 Blue:5    | ←             | ←    | √               |        | K/C  |
| Preset Setup      |                         |               |      |                 |        |  |
| State             | Factory                 | Non-changing  | ←    |                 | √      | K  |
| Confirm           | ON                      | Non-changing  | ←    |                 | √      | K  |
| Backlight         | ON                      | ←             | ←    |                 |        | K/C  |
| Service Menu      |                         |               |      |                 |        |  |
| Security Level    | None                    | ←             | ←    | √               |        | K/C  |

---

## **D**      **Softkey Functions**

This appendix explains the functions of softkeys and hardkeys supplied on the Agilent E5061A/E5062A.

## E5061A/E5062A Menu (Top Menu)

| Key Operation                                  | Function  |
|--|---|
| <b>Double-click on each softkey menu title</b> | Displays the top menu of each menu item below. A preset operation will not cancel the menu display.   |
| <b>Measurement</b>                             | Same as <b>Meas</b> . See “Measurement Menu” on page 344.   |
| <b>Format</b>                                  | Same as <b>Format</b> . See “Format Menu” on page 334.  |
| <b>Scale</b>                                   | Same as <b>Scale</b> . See “Scale Menu” on page 349.  |
| <b>Display</b>                                 | Same as <b>Display</b> . See “Display Menu” on page 331.  |
| <b>Average</b>                                 | Same as <b>Avg</b> . See “Average Menu” on page 324.  |
| <b>Calibration</b>                             | Same as <b>Cal</b> . See “Calibration Menu” on page 325.  |
| <b>Stimulus</b>                                | Displays the same softkey for setting up the sweep range that appears when <b>Start</b> , <b>Stop</b> , <b>Center</b> , or <b>Span</b> is pressed. See “Stimulus Menu” on page 350. |
| <b>Sweep Setup</b>                             | Same as <b>Sweep Setup</b> . See “Sweep Setup Menu” on page 351.  |
| <b>Trigger</b>                                 | Same as <b>Trigger</b> . See “Trigger Menu” on page 357.  |
| <b>Marker</b>                                  | Same as <b>Marker</b> . See “Marker Menu” on page 337.  |
| <b>Marker Search</b>                           | Same as <b>Marker Search</b> . See “Marker Search Menu” on page 340.  |
| <b>Marker Function</b>                         | Same as <b>Marker Fctn</b> . See “Marker Function Menu” on page 339.  |
| <b>Analysis</b>                                | Same as <b>Analysis</b> . See “Analysis Menu” on page 323.  |
| <b>Macro Setup</b>                             | Same as <b>Macro Setup</b> . See “Macro Setup Menu” on page 335.  |
| <b>Save/Recall</b>                             | Same as <b>Save/Recall</b> . See “Save/Recall Menu” on page 346.  |
| <b>System</b>                                  | Same as <b>System</b> . See “System Menu” on page 353.  |
| <b>Preset</b>                                  | Same as <b>Preset</b> . See “Preset Menu” on page 345.  |



## Analysis Menu

| Key Operation               | Function  | SCPI Command              |
|-----------------------------|---|---------------------------|
| <b>Analysis</b>             | Displays softkeys for performing analysis functions.  |                           |
| <b>Conversion</b>           | Displays softkeys for setting up the conversion function.   |                           |
| <b>Conversion</b>           | Enables or disables the conversion function.  | :CALC{1-4}:CONV           |
| <b>Function</b>             | Displays softkeys for selecting a converted parameter.  |                           |
| <b>Z:Reflection</b>         | Selects the equivalent impedance in reflection measurement.   | :CALC{1-4}:CONV:FUNC ZREF |
| <b>Z:Transmission</b>       | Selects the equivalent impedance in transmission measurement.   | :CALC{1-4}:CONV:FUNC ZTR  |
| <b>Y:Reflection</b>         | Selects the equivalent admittance in reflection measurement.  | :CALC{1-4}:CONV:FUNC YREF |
| <b>Y:Transmission</b>       | Selects the equivalent admittance in transmission measurement.  | :CALC{1-4}:CONV:FUNC YTR  |
| <b>1/S</b>                  | Selects the inverse S-parameter.  | :CALC{1-4}:CONV:FUNC INV  |
| <b>Cancel</b>               | Returns to the softkey display screen one level higher.   |                           |
| <b>Return</b>               | Returns to the softkey display screen one level higher.   |                           |
| <b>Limit Test</b>           | Displays softkeys for setting up the limit test function.   |                           |
| <b>Limit Test</b>           | Enables or disables the limit test function.  | :CALC{1-4}:LIM            |
| <b>Limit Line</b>           | Enables or disables the limit line display.   | :CALC{1-4}:LIM:DISP       |
| <b>Clip Lines</b>           | Toggles on/off the display of part of a limit line(s) that is not used for evaluation.                            | :CALC{1-4}:LIM:DISP:CLIP  |
| <b>Edit Limit Line</b>      | Displays softkeys for editing the limit line.   |                           |
| <b>Delete</b>               | Deletes the line at the cursor from the limit table.  | :CALC{1-4}:LIM:DATA       |
| <b>Add</b>                  | Adds a new segment to the limit table under the line on which the cursor is located.                              | :CALC{1-4}:LIM:DATA       |
| <b>Clear Limit Table</b>    | Displays softkeys for clearing the contents of the limit table.   |                           |
| <b>OK</b>                   | Deletes all segments in the limit table.  | :CALC{1-4}:LIM:DATA       |
| <b>Cancel</b>               | Returns to the softkey display screen one level higher.   |                           |
| <b>Export to CSV File</b>   | Exports (saves the data in formats used by other software) the limit table to a CSV (comma-separated value) file. | :MMEM:STOR:LIM            |
| <b>Import from CSV File</b> | Imports (loads the data from files in different formats) a CSV (comma-separated value) file to the limit table.   | :MMEM:LOAD:LIM            |
| <b>Return</b>               | Returns to the softkey display screen one level higher.   |                           |
| <b>Fail Sign</b>            | Turns on/off the display of the limit test fail sign.   | :DISP:FSIG                |
| <b>Return</b>               | Returns to the softkey display screen one level higher.   |                           |
| <b>Return</b>               | Returns to the "E5061A/E5062A Menu (Top Menu)" on page 322.   |                           |

## Average Menu

| Key Operation                      | Function   | SCPI Command                          |
|------------------------------------|--|---------------------------------------|
| <input type="button" value="Avg"/> | Displays softkeys for setting averaging options.   |                                       |
| <b>Averaging Restart</b>           | Resets the counter and restarts from "1".  | :SENS{1-4}:AVER:CLE                   |
| <b>Avg Factor</b>                  | Sets the averaging factor. The averaging factor must be defined as an integer from 1 to 999.   | :SENS{1-4}:AVER:COUN                  |
| <b>Averaging</b>                   | Enables or disables averaging execution  | :SENS{1-4}:AVER                       |
| <b>Smo Aperture</b>                | Sets the smoothing aperture using a percentage against the sweep span  | :CALC{1-4}:SMO:APER                   |
| <b>Smoothing</b>                   | Enables or disables the smoothing function. When enabled, the letters "Smo" will appear in the trace status area.  | :CALC{1-4}:SMO:STAT                   |
| <b>IF Bandwidth</b>                | Sets the IF bandwidth. For more about the effective range of the IF bandwidth, refer to "Specifications and Reference Data". If an input value is out of the range, it will automatically be modified to the closest value in the effective range. A narrow IF bandwidth slows down the sweep speed, but improves the S/N ratio. | :SENS{1-4}:BAND or<br>:SENS{1-4}:BWID |
| <b>Return</b>                      | Returns to the "E5061A/E5062A Menu (Top Menu)" on page 322.  |                                       |

## Calibration Menu

| Key Operation        | Function   | SCPI Command                   |
|----------------------|--|--------------------------------|
| Cal                  | Displays softkeys for setting and executing calibrations.  |                                |
| Correction           | Enables or disables error correction.  | :SENS{1-4}:CORR:STAT           |
| Calibrate            | Displays softkeys for selecting calibration options.   |                                |
| Response (Open)      | Displays softkeys for selecting options for response calibration using the OPEN standard.  |                                |
| Port                 | Selects test port 1 or test port 2.  | :SENS{1-4}:CORR:COLL:METH:OPEN |
| Open                 | Executes a response calibration using the OPEN standard on the test port selected in the <b>Port</b> menu. This calibration is effective for eliminating response tracking errors. | :SENS{1-4}:CORR:COLL:OPEN      |
| Load (Optional)      | Executes an isolation calibration using the LOAD standard on the test port selected in the <b>Port</b> menu. This calibration is effective for eliminating directivity errors.     | :SENS{1-4}:CORR:COLL:LOAD      |
| Done                 | Terminates a calibration process and calculates the calibration coefficients.  | :SENS{1-4}:CORR:COLL:SAVE      |
| Cancel               | Displays softkeys for canceling a calibration.   |                                |
| OK                   | Cancels the calibration in progress.   | None                           |
| Cancel               | Returns to the softkey display screen one level higher.  |                                |
| Return               | Returns to the softkey display screen one level higher.  |                                |
| Response (Short)     | Displays softkeys for selecting options for a response calibration using the SHORT standard.   |                                |
| Port                 | Selects test port 1 or test port 2.  | :SENS{1-4}:CORR:COLL:METH:SHOR |
| Short                | Executes a SHORT calibration on the test port selected in the <b>Port</b> menu. This calibration is effective for eliminating reflection tracking errors.                          | :SENS{1-4}:CORR:COLL:SHOR      |
| Load (Optional)      | Executes an isolation calibration using the LOAD standard on the test port selected in the <b>Port</b> menu. This calibration is effective for eliminating directivity errors.     | :SENS{1-4}:CORR:COLL:LOAD      |
| Done                 | Terminates a calibration process and calculates the calibration coefficients.  | :SENS{1-4}:CORR:COLL:SAVE      |
| Cancel               | Displays softkeys for canceling a calibration.   |                                |
| OK                   | Cancels the calibration in progress.   | None                           |
| Cancel               | Returns to the softkey display screen one level higher.  |                                |
| Return               | Returns to the softkey display screen one level higher.  |                                |
| Response (Thru)      | Displays softkeys for selecting options for response calibrations using the THRU standard.   |                                |
| Ports                | Selects test ports 1-2 (S12) or test ports 2-1 (S21).  | :SENS{1-4}:CORR:COLL:METH:THRU |
| Thru                 | Executes a THRU response calibration on the test ports selected in the <b>Ports</b> menu. This calibration is effective for eliminating transmission tracking errors.              | :SENS{1-4}:CORR:COLL:THRU      |
| Isolation (Optional) | Executes an isolation calibration on the test ports selected in the <b>Ports</b> menu. This calibration is effective for eliminating isolation errors.                             | :SENS{1-4}:CORR:COLL:ISOL      |
| Done                 | Terminates a calibration process and calculates the calibration coefficients.  | :SENS{1-4}:CORR:COLL:SAVE      |
| Cancel               | Displays softkeys for canceling a calibration.   |                                |
| OK                   | Cancels the calibration in progress.   | None                           |
| Cancel               | Returns to the softkey display screen one level higher.  |                                |

## Softkey Functions Calibration Menu

| Key Operation        | Function  | SCPI Command                    |
|----------------------|---|---------------------------------|
| Cal                  | (Continued)   |                                 |
| Calibrate            |   |                                 |
| Response (Thru)      |   |                                 |
| Return               | Returns to the softkey display screen one level higher.                         |                                 |
| Enhanced Response    | Displays softkeys for selecting options for enhanced response calibrations.     |                                 |
| Ports                | Selects test ports 1-2 (S12) or test ports 2-1 (S21).                           | :SENS{1-4}:CORR:COLL:METH:ERES  |
| Open                 | Executes an OPEN calibration on the test port selected in the <b>Port</b> menu. | :SENS{1-4}:CORR:COLL:OPEN       |
| Short                | Executes a SHORT calibration on the test port selected in the <b>Port</b> menu. | :SENS{1-4}:CORR:COLL:SHOR       |
| Load                 | Executes a LOAD calibration on the test port selected in the <b>Port</b> menu.  | :SENS{1-4}:CORR:COLL:LOAD       |
| Thru                 | Executes a THRU calibration on test ports 1 and 2.                              | :SENS{1-4}:CORR:COLL:THRU       |
| Isolation (Optional) | Executes an isolation calibration on test ports 1 and 2.                        | :SENS{1-4}:CORR:COLL:ISOL       |
| Done                 | Terminates a calibration process and calculates the calibration coefficients.   | :SENS{1-4}:CORR:COLL:SAVE       |
| Cancel               | Displays softkeys for canceling a calibration.                                  |                                 |
| OK                   | Cancels the calibration in progress.  | None                            |
| Cancel               | Returns to the softkey display screen one level higher.                         |                                 |
| Return               | Returns to the softkey display screen one level higher.                         |                                 |
| 1-Port Cal           | Displays softkeys for executing 1-port calibrations.                            |                                 |
| Port                 | Selects test port 1 or test port 2.   | :SENS{1-4}:CORR:COLL:METH:SOLT1 |
| Open                 | Executes an OPEN calibration on the test port selected in the <b>Port</b> menu. | :SENS{1-4}:CORR:COLL:OPEN       |
| Short                | Executes a SHORT calibration on the test port selected in the <b>Port</b> menu. | :SENS{1-4}:CORR:COLL:SHOR       |
| Load                 | Executes a LOAD calibration on the test port selected in the <b>Port</b> menu.  | :SENS{1-4}:CORR:COLL:LOAD       |
| Done                 | Terminates a calibration process and calculates the calibration coefficients.   | :SENS{1-4}:CORR:COLL:SAVE       |
| Cancel               | Displays softkeys for canceling a calibration.                                  |                                 |
| OK                   | Cancels the calibration in progress.  | None                            |
| Cancel               | Returns to the softkey display screen one level higher.                         |                                 |
| Return               | Returns to the softkey display screen one level higher.                         |                                 |
| 2-Port Cal           | Displays softkeys for executing a full 2-port calibration.                      |                                 |
| Reflection           | Displays softkeys for executing reflection calibrations.                        |                                 |
| Port 1 Open          | Executes an OPEN reflection calibration on test port 1.                         | :SENS{1-4}:CORR:COLL:OPEN 1     |
| Port 1 Short         | Executes a SHORT reflection calibration on test port 1.                         | :SENS{1-4}:CORR:COLL:SHOR 1     |
| Port 1 Load          | Executes a LOAD reflection calibration on test port 1.                          | :SENS{1-4}:CORR:COLL:LOAD 1     |
| Port 2 Open          | Executes an OPEN reflection calibration on test port 2.                         | :SENS{1-4}:CORR:COLL:OPEN 2     |
| Port 2 Short         | Executes a SHORT reflection calibration on test port 2.                         | :SENS{1-4}:CORR:COLL:SHOR 2     |
| Port 2 Load          | Executes a LOAD reflection calibration on test port 2.                          | :SENS{1-4}:CORR:COLL:LOAD 2     |
| Return               | Returns to the softkey display screen one level higher.                         |                                 |

| Key Operation        | Function  | SCPI Command   |
|----------------------|---|--|
| Cal                  | (Continued)   |  |
| Calibrate            |   |  |
| 2-Port Cal           |   |  |
| Transmission         | Displays softkeys for executing transmission calibrations.                    |  |
| Port 1-2 Thru        | Executes a THRU calibration on test ports 1 and 2.                            | :SENS{1-4}:CORR:COLL:THRU 1,2<br>:SENS{1-4}:CORR:COLL:THRU 2,1 |
| Return               | Returns to the softkey display screen one level higher.                       |  |
| Isolation (Optional) | Displays softkeys for executing isolation calibrations.                       |  |
| Port 1-2 Isol        | Executes an isolation calibration on test ports 1 and 2.                      | :SENS{1-4}:CORR:COLL:ISOL 1,2<br>:SENS{1-4}:CORR:COLL:ISOL 2,1 |
| Return               | Returns to the softkey display screen one level higher.                       |  |
| Done                 | Terminates a calibration process and calculates the calibration coefficients. | :SENS{1-4}:CORR:COLL:SAVE                                      |
| Cancel               | Displays softkeys for canceling a calibration.                                |  |
| OK                   | Cancels the calibration in progress.  | None   |
| Cancel               | Returns to the softkey display screen one level higher.                       |  |
| Return               | Returns to the softkey display screen one level higher.                       |  |
| Return               | Returns to the softkey display screen one level higher.                       |  |
| ECal                 | Displays softkeys for executing ECal (Electronic Calibrations).               |  |
| Response (Thru)      | Displays softkeys for executing THRU response calibration.                    |  |
| 2-1 (S21)            | Executes a THRU ECal for test port 1→2.                                       | :SENS{1-4}:CORR:COLL:ECAL:THRU 2,1                             |
| 1-2 (S12)            | Executes a THRU ECal for test port 2→1.                                       | :SENS{1-4}:CORR:COLL:ECAL:THRU 1,2                             |
| Return               | Returns to the softkey display screen one level higher.                       |  |
| Enhanced Response    | Displays softkeys for executing enhanced response calibration.                |  |
| 2-1 (S21,S11)        | Executes a Enhanced Response ECal for test port 1→2.                          | :SENS{1-4}:CORR:COLL:ECAL:ERES 2,1                             |
| 1-2 (S12,S22)        | Executes a Enhanced Response ECal for test port 2→1.                          | :SENS{1-4}:CORR:COLL:ECAL:ERES 1,2                             |
| Return               | Returns to the softkey display screen one level higher.                       |  |
| 1-Port Cal           | Displays softkeys for executing 1-port ECal                                   |  |
| Port 1               | Executes a 1-port ECal on test port 1.  | :SENS{1-4}:CORR:COLL:ECAL:SOLT1 1                              |
| Port 2               | Executes a 1-port ECal on test port 2.  | :SENS{1-4}:CORR:COLL:ECAL:SOLT1 2                              |
| Return               | Returns to the softkey display screen one level higher.                       |  |
| 2-Port ECal          | Execute a 2-port ECal.  | :SENS{1-4}:CORR:COLL:ECAL:SOLT2 1,2                            |
| Isolation            | Enables or disables isolation calibration.                                    | :SENS{1-4}:CORR:COLL:ECAL:ISOL                                 |
| Return               | Returns to the softkey display screen one level higher.                       |  |
| Clear All            | Displays softkeys for executing clear the all calibration data.               |  |
| OK                   | Executes to clear the all calibration data.                                   | :SENS{1-4}:CORR:CLE  |
| Cancel               | Returns to the softkey display screen one level higher.                       |  |

## Softkey Functions Calibration Menu

| Key Operation         | Function  | SCPI Command                              |
|-----------------------|---|---|
| <b>Cal</b>            | (Continued)   |   |
| <b>Property</b>       | Enables or disables the display of calibration property. When enabled, calibration status information between test ports will be displayed in a matrix format in the lower-right corner of the channel window.  | :SENS{1-4}:CORR:PROP                      |
| <b>Cal Kit</b>        | Displays softkeys for selecting calibration kits. Up to ten calibration kits may be defined. Calibration kits 85033E, 85033D, 85052D, 85032F, 85032B/F, 85036B/E, 85039B, and 85038A/F/M are pre-defined with default settings.   |   |
| <b>85033E</b>         | Selects calibration kit 85033E.   | :SENS{1-4}:CORR:COLL:CKIT 1               |
| <b>85033D</b>         | Selects calibration kit 85033D.   | :SENS{1-4}:CORR:COLL:CKIT 2               |
| <b>85052D</b>         | Selects calibration kit 85052D.   | :SENS{1-4}:CORR:COLL:CKIT 3               |
| <b>85032F</b>         | Selects calibration kit 85032F.   | :SENS{1-4}:CORR:COLL:CKIT 4               |
| <b>85032B/E</b>       | Selects calibration kit 85032B/E.   | :SENS{1-4}:CORR:COLL:CKIT 5               |
| <b>85036B/E</b>       | Selects calibration kit 85036B/E.   | :SENS{1-4}:CORR:COLL:CKIT 6               |
| <b>85039B</b>         | Selects calibration kit 85039B.   | :SENS{1-4}:CORR:COLL:CKIT 7               |
| <b>85038A/F/M</b>     | Selects calibration kit 85038A/F/M.   | :SENS{1-4}:CORR:COLL:CKIT 8               |
| <b>User</b>           | Selects a user-defined calibration kit.   | :SENS{1-4}:CORR:COLL:CKIT 9               |
| <b>User</b>           | Selects a user-defined calibration kit.   | :SENS{1-4}:CORR:COLL:CKIT 10              |
| <b>Cancel</b>         | Returns to the softkey display screen one level higher.   |   |
| <b>Modify Cal Kit</b> | Displays softkeys for changing the definition of the calibration kit selected in the <b>Cal Kit</b> menu.   |   |
| <b>Define STDs</b>    | Displays softkeys for defining the standard for a calibration kit. The label ( <b>Std Name</b> ) on each softkey represents the name of each standard. As a default setting, undefined standards are tagged with a <b>No Name</b> label. Up to 21 standards may be defined. |   |
| <b>1. (Std Name)</b>  | Displays softkeys for changing the definition of <b>1. (Std Name)</b> .   |   |
| <b>Label</b>          | Defines the name of the standard No.1. Once named, the new name will appear as a label for the corresponding softkey, which is represented as ( <b>Std Name</b> ) in this manual.   | :SENS{1-4}:CORR:COLL:CKIT:STAN1:LAB       |
| <b>STD Type</b>       | Displays softkeys for setting the types of standards. A standard type is a classification of a standard based on its form and construction. There are five standard types: OPEN, SHORT, LOAD, delay/THRU, and arbitrary impedance.  |   |
| <b>Open</b>           | Selects "OPEN" as the standard type.  | :SENS{1-4}:CORR:COLL:CKIT:STAN1:TYPE OPEN |
| <b>Short</b>          | Selects "SHORT" as the standard type.   | :SENS{1-4}:CORR:COLL:CKIT:STAN1:TYPE SHOR |
| <b>Load</b>           | Selects "LOAD" as the standard type.  | :SENS{1-4}:CORR:COLL:CKIT:STAN1:TYPE LOAD |
| <b>Delay/Thru</b>     | Selects "delay/THRU" as the standard type.  | :SENS{1-4}:CORR:COLL:CKIT:STAN1:TYPE THRU |
| <b>Arbitrary</b>      | Selects "arbitrary impedance" as the standard type.   | :SENS{1-4}:CORR:COLL:CKIT:STAN1:TYPE ARBI |
| <b>None</b>           | Does not select any standard type.  | :SENS{1-4}:CORR:COLL:CKIT:STAN1:TYPE NONE |
| <b>Cancel</b>         | Returns to the softkey display screen one level higher.   |   |
| <b>C0</b>             | Sets the value of C0 (F) for the standard. The fringe capacitance (F) of a standard is determined by the following formula:<br>$C = (C0) + (C1 \times F) + (C2 \times F^2) + (C3 \times F^3)$<br>(F: measurement frequency [Hz])  | :SENS{1-4}:CORR:COLL:CKIT:STAN1:C0        |
| <b>C1</b>             | Sets the value of C1 (F/Hz) for the standard.   | :SENS{1-4}:CORR:COLL:CKIT:STAN1:C1        |





| Key Operation  | Function  | SCPI Command                             |
|----------------|---|--|
| Cal            | (Continued)   |  |
| Modify Cal Kit |   |  |
| Define STDs    |   |  |
| 1. (Std Name)  |   |  |
| C2             | Sets the value of C2 (F/Hz <sup>2</sup> ) for the standard.   | :SENS{1-4}:CORR:COLL:CKIT:STAN1:<br>C2   |
| C3             | Sets the value of C3 (F/Hz <sup>3</sup> ) for the standard.   | :SENS{1-4}:CORR:COLL:CKIT:STAN1:<br>C3   |
| L0             | Sets the value of L0 (H) for the standard. The residual inductance (H) of a standard is determined by the following formula:<br>$L = (L0) + (L1 \times F) + (L2 \times F^2) + (L3 \times F^3)$ (F: measurement frequency [Hz])  | :SENS{1-4}:CORR:COLL:CKIT:STAN1:<br>L0   |
| L1             | Sets the value of L1 (H/Hz) for the standard.   | :SENS{1-4}:CORR:COLL:CKIT:STAN1:<br>L1   |
| L2             | Sets the value of L2 (H/Hz <sup>2</sup> ) for the standard.   | :SENS{1-4}:CORR:COLL:CKIT:STAN1:<br>L2   |
| L3             | Sets the value of L3 (H/Hz <sup>3</sup> ) for the standard.   | :SENS{1-4}:CORR:COLL:CKIT:STAN1:<br>L3   |
| Offset Delay   | Sets the offset delay (sec.) for the standard. The offset delay is a delay caused by the length of the transmission line between the standard to be defined and the actual measurement plane. For the OPEN, SHORT, and LOAD standards, input the one-way transmission time (sec.) from the measurement plane to the standard. For the THRU standard, input the one-way transmission time (sec.) from one measurement plane to the other. The offset delay can be obtained either by measuring it or by dividing the exact physical length of the standard by the velocity factor. | :SENS{1-4}:CORR:COLL:CKIT:STAN1:<br>DEL  |
| Offset Z0      | Sets the impedance Z0 between the measurement plane and the standard being defined. Normally, this value is set to the characteristic impedance of the system.  | :SENS{1-4}:CORR:COLL:CKIT:STAN1:<br>Z0   |
| Offset Loss    | Sets the offset loss for the standard. The offset loss is an energy loss due to skin effect on the length of single coaxial cable. Input the energy loss at 1 GHz using the unit Ω/sec. In most applications, setting the offset loss to "0" should not affect the result. The offset loss of a standard can be determined by measuring the offset delay and the loss at 1 GHz and then substituting them in the following formula:<br>$\text{Loss}(\Omega/\text{s}) = \frac{\text{loss}(\text{dB}) \times Z_0(\Omega)}{4.3429(\text{dB}) \times \text{delay}(\text{s})}$         | :SENS{1-4}:CORR:COLL:CKIT:STAN1:<br>LOSS |
| Arb. Impedance | Sets the value for the LOAD standard. Use this option to input an arbitrary impedance that is different from the system impedance.  | :SENS{1-4}:CORR:COLL:CKIT:STAN1:<br>ARB  |
| Return         | Returns to the softkey display screen one level higher.   |  |
| 2. (Std Name)  | Displays softkeys for changing the definition of <b>2. (Std Name)</b> . The lower-level softkeys displayed are the same as those for <b>1. (Std Name)</b> .   |  |
| .              | .   |  |
| .              | .   |  |
| 21. (Std Name) | Displays softkeys for changing the definition of <b>21. (Std Name)</b> . The lower-level softkeys displayed are the same as those for <b>1. (Std Name)</b> .  |  |
| Return         | Returns to the softkey display screen one level higher.   |  |

## Softkey Functions Calibration Menu



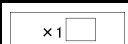
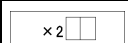
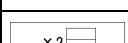
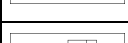
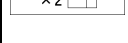
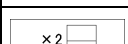

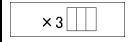
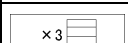
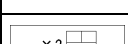
| Key Operation           | Function  | SCPI Command                            |
|-------------------------|---|---|
| <b>Cal</b>              | (Continued)   |   |
| <b>Modify Cal Kit</b>   |   |   |
| <b>Specify CLSs</b>     | Displays softkeys for setting the classes of standards. A standard class refers to a set of standards that are used in the process of calibration. For each class of OPEN, SHORT, LOAD, and THRU, designate standards to be used from among the 21 standards. |   |
| <b>Open</b>             | Displays softkeys for selecting standards for the OPEN standard class.  |   |
| <b>Set All</b>          | Displays softkeys for selecting standards for the OPEN standard class that applies to all test ports.   |   |
| <b>1. (Std Name)</b>    | Includes <b>1. (Std Name)</b> in the OPEN standard class.   | :SENS{1-4}:CORR:COLL:CKIT:ORD:OPEN x,1  |
| <b>2. (Std Name)</b>    | Includes <b>2. (Std Name)</b> in the OPEN standard class.   | :SENS{1-4}:CORR:COLL:CKIT:ORD:OPEN x,2  |
| .                       | .   | .                                       |
| <b>21. (Std Name)</b>   | Includes <b>21. (Std Name)</b> in the OPEN standard class.  | :SENS{1-4}:CORR:COLL:CKIT:ORD:OPEN x,21 |
| <b>Cancel</b>           | Returns to the softkey display screen one level higher.   |   |
| <b>Port 1</b>           | Displays softkeys for selecting standards for the OPEN standard class that applies only to test port 1. The lower-level softkeys are the same as those for <b>Set All</b> .   |   |
| <b>Port 2</b>           | Displays softkeys for selecting standards for the OPEN standard class that applies only to test port 2. The lower-level softkeys are the same as those for <b>Set All</b> .   |   |
| <b>Return</b>           | Returns to the softkey display screen one level higher.   |   |
| <b>Short</b>            | Displays softkeys for selecting standards for the SHORT standard class. The lower-level softkeys displayed are the same as those for <b>Open</b> .  | :SENS{1-4}:CORR:COLL:CKIT:ORD:SHORT     |
| <b>Load</b>             | Displays softkeys for selecting standards for the LOAD standard class. The lower-level softkeys displayed are the same as those for <b>Open</b> .   | :SENS{1-4}:CORR:COLL:CKIT:ORD:LOAD      |
| <b>Thru</b>             | Displays softkeys for selecting standards for the THRU standard class. The lower-level softkeys displayed are the same as those for <b>Open</b> .   | :SENS{1-4}:CORR:COLL:CKIT:ORD:THRU      |
| <b>Return</b>           | Returns to the softkey display screen one level higher.   |   |
| <b>Label Kit</b>        | Allows the user to label the calibration kit.   | :SENS{1-4}:CORR:COLL:CKIT:LAB           |
| <b>Restore Cal Kit</b>  | Displays softkeys for initializing the definition of calibration kit.   |   |
| <b>OK</b>               | Restores the definition of the calibration kit selected by <b>Cal Kit</b> to factory default settings.  | :SENS{1-4}:CORR:COLL:CKIT:RES           |
| <b>Cancel</b>           | Returns to the softkey display screen one level higher.   |   |
| <b>Return</b>           | Returns to the softkey display screen one level higher.   |   |
| <b>Port Extensions</b>  | Displays softkeys for extending ports.  |   |
| <b>Extensions</b>       | Enables or disables the port extension function.  | :SENS{1-4}:CORR:EXT                     |
| <b>Extension Port 1</b> | Sets the value for test port 1 extension (sec.).  | :SENS{1-4}:CORR:EXT:PORT 1              |
| <b>Extension Port 2</b> | Sets the value for test port 2 extension (sec.).  | :SENS{1-4}:CORR:EXT:PORT 2              |
| <b>Return</b>           | Returns to the softkey display screen one level higher.   |   |
| <b>Velocity Factor</b>  | Sets the velocity factor.   | :SENS{1-4}:CORR:RVEL:COAX               |
| <b>Set Z0</b>           | Sets the system impedance.  | :SENS:CORR:IMP                          |
| <b>Return</b>           | Returns to the "E5061A/E5062A Menu (Top Menu)" on page 322.   |   |

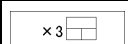
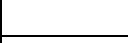
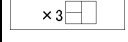

## Display Menu

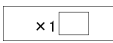
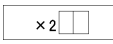
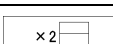
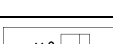
| Key Operation   | Function   | SCPI Command                 |
|---|--|------------------------------|
| <b>Display</b>  | Displays softkeys for setting up display options.  |                              |
| <b>Allocate Channels</b>  | Displays softkeys for setting the number of channels to be displayed and the channel window arrangement. The execution of measurements does not depend on the display status of each channel (measurements can be performed on channels that are not displayed). The user can set up each channel for measurements (by selecting the sweep mode and the trigger source) from the “Trigger Menu” on page 357. |                              |
|    | Displays channel 1 using the entire display screen.  | <b>:DISP:SPL D1</b>          |
|    | Displays channel windows by bisecting the screen horizontally with channel 1 on the left and channel 2 on the right.   | <b>:DISP:SPL D12</b>         |
|    | Displays channel windows by bisecting the screen vertically, with channel 1 displayed above channel 2.   | <b>:DISP:SPL D1_2</b>        |
|    | Displays channel windows by splitting the screen vertically (with the left window occupying 2/3 of the screen), with channel 1 on the left and channel 2 on the right.   | <b>:DISP:SPL D112</b>        |
|    | Displays channel windows by splitting the screen vertically (with the upper window occupying 2/3 of the screen), and channel 1 displayed above channel 2.  | <b>:DISP:SPL D1_1_2</b>      |
|    | Displays channel windows by trisecting the screen horizontally, with channels 1, 2, and 3 displayed from left to right.  | <b>:DISP:SPL D123</b>        |
|    | Displays channel windows by trisecting the screen vertically with channels 1, 2, and 3 arranged from top to bottom.  | <b>:DISP:SPL D1_2_3</b>      |
|    | Displays channel windows by bisecting the screen vertically and then bisecting the upper window horizontally with channels 1, 2, and 3 displayed, respectively, in the upper-left corner, upper-right corner, and bottom.  | <b>:DISP:SPL D12_33</b>      |
|   | Displays channel windows by bisecting the screen vertically and then bisecting the lower window horizontally with channels 1, 2, and 3 displayed, respectively, in the top, lower-left corner, and lower-right corner.   | <b>:DISP:SPL D11_23</b>      |
|  | Displays channel windows by bisecting the screen horizontally and then bisecting the left window vertically, with channels 1, 2, and 3 displayed, respectively, in the upper-left corner, lower-left corner, and on the right.   | <b>:DISP:SPL D13_23</b>      |
|  | Displays channel windows by bisecting the screen horizontally and then bisecting the right window vertically, with channels 1, 2, and 3 displayed, respectively, on the left, in the upper-right corner, and lower-right corner.   | <b>:DISP:SPL D12_13</b>      |
|  | Displays channel windows by splitting the screen horizontally into four equal parts, with channels 1, 2, 3, and 4 displayed from left to right.  | <b>:DISP:SPL D1234</b>       |
|  | Displays channel windows by splitting the screen vertically into four equal parts, with channels 1, 2, 3, and 4 displayed from top to bottom.  | <b>:DISP:SPL D1_2_3_4</b>    |
|  | Displays channel windows by bisecting the screen both vertically and horizontally with channels 1, 2, 3, and 4 in the upper-left, upper-right, lower-left corner, and lower-right corners, respectively.   | <b>:DISP:SPL D12_34</b>      |
| <b>Cancel</b>   | Returns to the softkey display screen one level higher.  |                              |
| <b>Number of Traces</b>   | Displays softkeys for setting the number of traces.  |                              |
| <b>1</b>  | Sets the number of traces to one for the active channel.   | <b>:CALC{1-4};PAR:COUN 1</b> |
| <b>2</b>  | Sets the number of traces to two for the active channel.   | <b>:CALC{1-4};PAR:COUN 2</b> |
| <b>3</b>  | Sets the number of traces to three for the active channel.   | <b>:CALC{1-4};PAR:COUN 3</b> |
| <b>4</b>  | Sets the number of traces to four for the active channel.  | <b>:CALC{1-4};PAR:COUN 4</b> |
| <b>Cancel</b>   | Returns to the softkey display screen one level higher.  |                              |

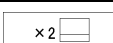
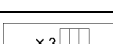
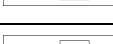
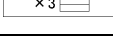
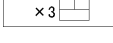
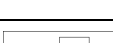
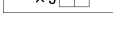
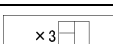
## Softkey Functions Display Menu

| Key Operation   | Function  | SCPI Command  |
|---|---|---|
| <b>Display</b>  | (Continued)   |   |
| <b>Allocate Traces</b>  | Displays softkeys for setting up the trace display arrangement. Traces are displayed based on the order determined from the graph arrangement currently being used. If the number of traces is less than the number of graphs, nothing will be displayed in the extra area(s). If the number of traces is more than the number of graphs, the remaining traces will be displayed by going back to the first graph, overlapping existing traces. |   |
|    | Displays channel 1 using the entire channel window.   | :DISP:WIND{1-4}:SPL D1  |
|    | Displays graphs by bisecting the screen horizontally with graph 1 on the left and graph 2 on the right.   | :DISP:WIND{1-4}:SPL D1_2  |
|    | Displays graphs by bisecting the screen vertically, with graph 1 displayed above graph 2.   | :DISP:WIND{1-4}:SPL D12   |
|    | Displays graphs by splitting the screen vertically (with the left window occupying 2/3 of the screen), with graph 1 on the left and graph 2 on the right.   | :DISP:WIND{1-4}:SPL D112  |
|    | Displays graphs by splitting the screen vertically (with the upper window occupying 2/3 of the screen), and graph 1 displayed above graph 2.  | :DISP:WIND{1-4}:SPL D1_1_2                                      |
|    | Displays graphs by trisecting the screen horizontally, with graphs 1, 2, and 3 displayed from left to right.  | :DISP:WIND{1-4}:SPL D123  |
|    | Displays graphs by trisecting the screen vertically with graphs 1, 2, and 3 arranged from top to bottom.  | :DISP:WIND{1-4}:SPL D1_2_3                                      |
|    | Displays graphs by bisecting the screen vertically and then bisecting the upper window horizontally with graphs 1, 2, and 3 displayed, respectively, in the upper-left corner, upper-right corner, and bottom.  | :DISP:WIND{1-4}:SPL D12_33                                      |
|    | Displays graphs by bisecting the screen vertically and then bisecting the lower window horizontally with graphs 1, 2, and 3 displayed, respectively, in the top, lower-left corner, and lower-right corner.   | :DISP:WIND{1-4}:SPL D11_23                                      |
|    | Displays graphs by bisecting the screen horizontally and then bisecting the left window vertically, with graphs 1, 2, and 3 displayed, respectively, in the upper-left corner, lower-left corner, and on the right.   | :DISP:WIND{1-4}:SPL D13_23                                      |
|   | Displays graphs by bisecting the screen horizontally and then bisecting the right window vertically, with graphs 1, 2, and 3 displayed, respectively, on the left, in the upper-right corner, and lower-right corner.   | :DISP:WIND{1-4}:SPL D12_13                                      |
|  | Displays graphs by splitting the screen horizontally into four equal parts, with graphs 1, 2, 3, and 4 displayed from left to right.  | :DISP:WIND{1-4}:SPL D1234                                       |
|  | Displays graphs by splitting the screen vertically into four equal parts, with graphs 1, 2, 3, and 4 displayed from top to bottom.  | :DISP:WIND{1-4}:SPL D1_2_3_4                                    |
|  | Displays graphs by bisecting the screen both vertically and horizontally with graphs 1, 2, 3, and 4 in the upper-left, upper-right, lower-left corner, and lower-right corners, respectively.   | :DISP:WIND{1-4}:SPL D12_34                                      |
| <b>Return</b>   | Returns to the softkey display screen one level higher.   |   |
| <b>Display</b>  | Displays softkeys for selecting between data trace and memory trace for on-screen display.  |   |
| <b>Data</b>   | Selects data trace for on-screen display. If the data math option was enabled in the <b>Data Math</b> menu, the computation results will also be displayed.   | :DISP:WIND{1-4}:TRAC{1-4}:STAT                                  |
| <b>Mem</b>  | Selects memory trace for on-screen display. To store data for a memory trace, go back to the previous menu and press <b>Data</b> → <b>Mem</b> .   | :DISP:WIND{1-4}:TRAC{1-4}:MEM                                   |
| <b>Data &amp; Mem</b>   | Selects both data trace and memory trace for on-screen display. By storing data obtained under certain conditions, it is possible to compare them to new measurement results (data trace) obtained under different conditions. To store data for a memory trace, go back to the previous menu and press <b>Data</b> → <b>Mem</b> .  | :DISP:WIND{1-4}:TRAC{1-4}:MEM<br>:DISP:WIND{1-4}:TRAC{1-4}:STAT |

| Key Operation           | Function  | SCPI Command  |
|-------------------------|---|---|
| <b>Display</b>          | (Continued)   |   |
| <b>Display</b>          |   |   |
| <b>OFF</b>              | Turns off both the data trace and memory trace.   | :DISP:WIND{1-4}:TRAC{1-4}:<br>MEM<br>:DISP:WIND{1-4}:TRAC{1-4}:<br>STAT |
| <b>Cancel</b>           | Returns to the softkey display screen one level higher.   |   |
| <b>Data → Mem</b>       | Stores the measured data for the current active trace in memory. Stored data can be displayed using the memory trace option. To enable/disable the memory trace, go to the <b>Display</b> menu.   | :CALC{1-4}:MATH:MEM   |
| <b>Data Math</b>        | Displays softkeys for selecting the types of data processing to be performed.   |   |
| <b>OFF</b>              | Disables the data processing function. Raw measurement data will be stored as a data trace.   | :CALC{1-4}:MATH:FUNC<br>NORM  |
| <b>Data / Mem</b>       | Divides the measured data by the memory trace data (normalization) and stores the results as a data trace. This function is used to evaluate the ratio between two traces (e.g., to evaluate gains and attenuations).   | :CALC{1-4}:MATH:FUNC DIV  |
| <b>Data * Mem</b>       | Multiplies the measured data by the memory trace data and stores the result as a data trace.  | :CALC{1-4}:MATH:FUNC<br>MULT  |
| <b>Data – Mem</b>       | Subtracts the memory trace data from the measured data (vector operation) and stores the results as a data trace. This function is useful in determining vector errors (e.g., directivity) and storing them for data compensation for future measurements.                  | :CALC{1-4}:MATH:FUNC<br>SUBT  |
| <b>Data + Mem</b>       | Adds the measured data to the memory trace data and stores the result as a data trace.  | :CALC{1-4}:MATH:FUNC<br>ADD   |
| <b>Cancel</b>           | Returns to the softkey display screen one level higher.   |   |
| <b>Edit Title Label</b> | Displays the input bar for editing title labels. Each channel is allowed to have a title label up to 100 characters in length. However, the entire title bar may not be displayed depending on the width of the channel window.   | :DISP:WIND{1-4}:TITL:DATA   |
| <b>Title Label</b>      | Enables or disables the title label display. Once a title label is assigned, it can be displayed within the title bar at the top of a channel window by enabling the title label display. Title labels are useful for adding extra information to saved data and printouts. | :DISP:WIND{1-4}:TITL  |
| <b>Graticule Label</b>  | Enables or disables the graticule label display for the Y-axis in a rectangular display format. Disabling the graticule label display will result in expanded graph areas.  | :DISP:WIND{1-4}:LAB   |
| <b>Graticule Label</b>  | Specifies the display format of the graticule label on the left side of the Y axis in the rectangular display format.   |   |
| <b>Auto</b>             | Specifies the normal display format.  | :DISP:WIND{1-4}:TRAC{1-4}:<br>ANN:YAX:MODE AUTO                         |
| <b>Relative</b>         | Specifies the relative value display, relative to the reference value.  | :DISP:WIND{1-4}:TRAC{1-4}:<br>ANN:YAX:MODE REL                          |
| <b>Invert Color</b>     | Inverts the display colors for all channel windows. Inverting colors from the normal display will create white backgrounds.   | :DISP:IMAG  |
| <b>Frequency</b>        | Enables or disables the frequency display on the screen. This function is useful for protecting critical information by making it impossible to obtain frequencies used in measurements just by glancing at the screen.   | :DISP:ANN:FREQ:STAT   |
| <b>Update</b>           | Enables or disables screen updates. When disabled, the analyzer can save time required for screen updates and thus improve measurement throughput. If it is not necessary to confirm results on the screen, this is an effective way to improve throughput.                 | :DISP:ENAB  |
| <b>Return</b>           | Returns to the “E5061A/E5062A Menu (Top Menu)” on page 322.   |   |

## Format Menu

| Key Operation         | Function  | SCPI Command                    |
|-----------------------|---|---------------------------------|
| <b>Format</b>         | Displays softkeys for setting up data formats.  |                                 |
| <b>Log Mag</b>        | Displays traces in a rectangular display format with log magnitude (dB) on the Y-axis and frequencies on the X-axis (log magnitude format).   | <b>:CALC{1-4};SEL:FORM MLOG</b> |
| <b>Phase</b>          | Displays traces in a rectangular display format with phase (-180° to +180°) on the Y-axis and frequencies on the X-axis (phase format).       | <b>:CALC{1-4};SEL:FORM PHAS</b> |
| <b>Group Delay</b>    | Displays traces in a rectangular display format with group delay (s) on the Y-axis and frequencies on the X-axis (group delay format).        | <b>:CALC{1-4};SEL:FORM GDEL</b> |
| <b>Smith</b>          | Displays softkeys for setting up smith chart.   |                                 |
| <b>Lin / Phase</b>    | Displays traces in Smith chart format. The marker response values are linear magnitude and phase (°).   | <b>:CALC{1-4};SEL:FORM SLIN</b> |
| <b>Log / Phase</b>    | Displays traces in Smith chart format. The marker response values are log magnitude (dB) and phase (°).                                       | <b>:CALC{1-4};SEL:FORM SLOG</b> |
| <b>Real / Imag</b>    | Displays traces in Smith chart format. The marker response values are the real and imaginary parts.   | <b>:CALC{1-4};SEL:FORM SCOM</b> |
| <b>R + jX</b>         | Displays traces in Smith chart format. The marker response values are resistance ( $\Omega$ ) and reactance ( $\Omega$ ).                     | <b>:CALC{1-4};SEL:FORM SMIT</b> |
| <b>G + jB</b>         | Displays traces in Smith chart format. The marker response values are conductance (S) and susceptance (S).                                    | <b>:CALC{1-4};SEL:FORM SMGB</b> |
| <b>Cancel</b>         | Returns to the softkey display screen one level higher.   |                                 |
| <b>Polar</b>          | Displays softkeys for setting up polar format.  |                                 |
| <b>Lin / Phase</b>    | Displays traces in polar format. The marker response values are linear magnitude and phase (°).   | <b>:CALC{1-4};SEL:FORM PLIN</b> |
| <b>Log / Phase</b>    | Displays traces in polar format. The marker response values are log magnitude (dB) and phase (°).   | <b>:CALC{1-4};SEL:FORM PLOG</b> |
| <b>Real / Imag</b>    | Displays traces in polar format. The marker response values are the real and imaginary parts.   | <b>:CALC{1-4};SEL:FORM POL</b>  |
| <b>Cancel</b>         | Returns to the softkey display screen one level higher.   |                                 |
| <b>Lin Mag</b>        | Displays traces in a rectangular display format with linear magnitude on the Y-axis and frequencies on the X-axis (linear magnitude format).  | <b>:CALC{1-4};SEL:FORM MLIN</b> |
| <b>SWR</b>            | Displays traces in a rectangular display format with SWR (standing wave ratio) on the Y-axis and frequencies on the X-axis (SWR format).      | <b>:CALC{1-4};SEL:FORM SWR</b>  |
| <b>Real</b>           | Displays traces in a rectangular display format with the real part on the Y-axis and frequencies on the X-axis (real format).                 | <b>:CALC{1-4};SEL:FORM REAL</b> |
| <b>Imaginary</b>      | Displays traces in a rectangular display format with the imaginary part on the Y-axis and frequencies on the X-axis (imaginary format).       | <b>:CALC{1-4};SEL:FORM IMAG</b> |
| <b>Expand Phase</b>   | Displays traces in a rectangular display format with expanded phase (°) on the Y-axis and frequencies on the X-axis (expanded phase format).  | <b>:CALC{1-4};SEL:FORM UPH</b>  |
| <b>Positive Phase</b> | Displays traces in a rectangular display format with phase (0° to +360°) on the Y-axis and frequencies on the X-axis (positive phase format). | <b>:CALC{1-4};SEL:FORM PPH</b>  |
| <b>Return</b>         | Returns to the "E5061A/E5062A Menu (Top Menu)" on page 322.   |                                 |

## Macro Setup Menu

| Key Operation  | Function  | SCPI Command                  |
|----------------|---|-------------------------------|
| Macro Setup    | Displays the macro setup menu.  |                               |
| VBA Editor     | Starts the VBA editor. A keyboard and mouse are necessary to use this editor.                                     | None                          |
| New Project    | Creates a new VBA project.  | None                          |
| Load Project   | Opens a dialog box for loading a saved VBA project.   | :MMEM:LOAD:PROG               |
| Load & Run     | Displays programs (VBA projects) stored under D:\VBA as a list of softkeys.                                       |                               |
| (program name) | Loads the program whose name is shown in the softkey label and executes it.                                       | None                          |
| :              | :   |                               |
| (program name) | Loads the program whose name is shown in the softkey label and executes it.                                       |                               |
| Return         | Returns to the softkey display screen one level higher.   |                               |
| Save Project   | Opens a dialog box for saving a VBA project.  | :MMEM:STOR:PROG               |
| Close Editor   | Closes the currently open VBA editor.   | None                          |
| Select Macro   | Displays a list of all macros in the form of softkeys from which they can be executed.                            |                               |
| (macro name)   | Executes the macro that corresponds to the softkey.   | :PROG:NAME                    |
| :              | :   | :PROG:STAT                    |
| (macro name)   | Executes the macro that corresponds to the softkey.   |                               |
| Cancel         | Returns to the softkey display screen one level higher.   |                               |
| Stop           | Stops execution of a program after executing the line of code being executed at the time the Stop key is pressed. | :PROG:STAT                    |
| Continue       | Resumes execution of a program that has been stopped.   | :PROG:STAT                    |
| Echo Window    | Enables or disables the echo window display at the bottom of the screen.  | :DISP:TABL<br>:DISP:TABL:TYPE |
| Clear Echo     | Clears text displayed in the echo window.   | :DISP:ECHO:CLE                |
| User Menu      | Displays user menu softkeys.  |                               |
| Button 1       | Executes the procedure assigned to <b>Button 1</b> . Softkey label can be modified using a command.               | None                          |
| Button 2       | Executes the procedure assigned to <b>Button 2</b> . Softkey label can be modified using a command.               | None                          |
| Button 3       | Executes the procedure assigned to <b>Button 3</b> . Softkey label can be modified using a command.               | None                          |
| Button 4       | Executes the procedure assigned to <b>Button 4</b> . Softkey label can be modified using a command.               | None                          |
| Button 5       | Executes the procedure assigned to <b>Button 5</b> . Softkey label can be modified using a command.               | None                          |
| Button 6       | Executes the procedure assigned to <b>Button 6</b> . Softkey label can be modified using a command.               | None                          |
| Button 7       | Executes the procedure assigned to <b>Button 7</b> . Softkey label can be modified using a command.               | None                          |
| Button 8       | Executes the procedure assigned to <b>Button 8</b> . Softkey label can be modified using a command.               | None                          |
| Button 9       | Executes the procedure assigned to <b>Button 9</b> . Softkey label can be modified using a command.               | None                          |

Softkey Functions  
**Macro Setup Menu**

| Key Operation    | Function   | SCPI Command |
|------------------|--|--------------|
| Macro Setup      | (Continued)  |              |
| User Menu        |  |              |
| Button 10        | Executes the procedure assigned to <b>Button 10</b> . Softkey label can be modified using a command. | None         |
| Return           | Returns to the softkey display screen one level higher.  |              |
| Preset User Menu | Returns the softkey labels of user menu to the initial settings.                                     | None         |
| Return           | Returns to the “E5061A/E5062A Menu (Top Menu)” on page 322.  |              |

## Marker Menu

| Key Operation            | Function   | SCPI Command  |
|--------------------------|--|---|
| <b>Marker</b>            | Activates marker 1 and displays an input dialog box for setting the stimulus value for marker 1. Also displays softkeys for setting and moving each marker.  |   |
| <b>Marker 1</b>          | Enables marker 1 if it is disabled. Also activates marker 1 and displays an input dialog box for setting the stimulus value.   | :CALC{1-4}:MARK1<br>:CALC{1-4}:MARK1:ACT<br>:CALC{1-4}:MARK1:X    |
| <b>Marker 2</b>          | Enables marker 2 if it is disabled. Also activates marker 2 and displays an input dialog box for setting the stimulus value.   | :CALC{1-4}:MARK2<br>:CALC{1-4}:MARK2:ACT<br>:CALC{1-4}:MARK2:X    |
| <b>Marker 3</b>          | Enables marker 3 if it is disabled. Also activates marker 3 and displays an input dialog box for setting the stimulus value.   | :CALC{1-4}:MARK3<br>:CALC{1-4}:MARK3:ACT<br>:CALC{1-4}:MARK3:X    |
| <b>Marker 4</b>          | Enables marker 4 if it is disabled. Also activates marker 4 and displays an input dialog box for setting the stimulus value.   | :CALC{1-4}:MARK4<br>:CALC{1-4}:MARK4:ACT<br>:CALC{1-4}:MARK4:X    |
| <b>More Markers</b>      | Displays softkeys for setting markers 5 to 9.  |   |
| <b>Marker 5</b>          | Enables marker 5 if it is disabled. Also activates marker 5 and displays an input dialog box for setting the stimulus value.   | :CALC{1-4}:MARK5<br>:CALC{1-4}:MARK5:ACT<br>:CALC{1-4}:MARK5:X    |
| <b>Marker 6</b>          | Enables marker 6 if it is disabled. Also activates marker 6 and displays an input dialog box for setting the stimulus value.   | :CALC{1-4}:MARK6<br>:CALC{1-4}:MARK6:ACT<br>:CALC{1-4}:MARK6:X    |
| <b>Marker 7</b>          | Enables marker 7 if it is disabled. Also activates marker 7 and displays an input dialog box for setting the stimulus value.   | :CALC{1-4}:MARK7<br>:CALC{1-4}:MARK7:ACT<br>:CALC{1-4}:MARK7:X    |
| <b>Marker 8</b>          | Enables marker 8 if it is disabled. Also activates marker 8 and displays an input dialog box for setting the stimulus value.   | :CALC{1-4}:MARK8<br>:CALC{1-4}:MARK8:ACT<br>:CALC{1-4}:MARK8:X    |
| <b>Marker 9</b>          | Enables marker 9 if it is disabled. Also activates marker 9 and displays an input dialog box for setting the stimulus value.   | :CALC{1-4}:MARK9<br>:CALC{1-4}:MARK9:ACT<br>:CALC{1-4}:MARK9:X    |
| <b>Return</b>            | Returns to the softkey display screen one level higher.  |   |
| <b>Ref Marker</b>        | Enables the reference marker if it is disabled (the reference marker mode [Ref Marker Mode] is enabled at the same time). Also activates the reference marker and displays an input dialog box for setting the stimulus value. | :CALC{1-4}:MARK10<br>:CALC{1-4}:MARK10:ACT<br>:CALC{1-4}:MARK10:X |
| <b>Clear Marker Menu</b> | Displays softkeys for turning off each marker.   |   |
| <b>All OFF</b>           | Turns off all markers on the active trace.   | None  |
| <b>Marker 1</b>          | Turns off marker 1 on the active trace.  | :CALC{1-4}:MARK1  |
| <b>Marker 2</b>          | Turns off marker 2 on the active trace.  | :CALC{1-4}:MARK2  |
| <b>Marker 3</b>          | Turns off marker 3 on the active trace.  | :CALC{1-4}:MARK3  |
| <b>Marker 4</b>          | Turns off marker 4 on the active trace.  | :CALC{1-4}:MARK4  |
| <b>Marker 5</b>          | Turns off marker 5 on the active trace.  | :CALC{1-4}:MARK5  |
| <b>Marker 6</b>          | Turns off marker 6 on the active trace.  | :CALC{1-4}:MARK6  |
| <b>Marker 7</b>          | Turns off marker 7 on the active trace.  | :CALC{1-4}:MARK7  |
| <b>Marker 8</b>          | Turns off marker 8 on the active trace.  | :CALC{1-4}:MARK8  |
| <b>Marker 9</b>          | Turns off marker 9 on the active trace.  | :CALC{1-4}:MARK9  |
| <b>Ref Marker</b>        | Turns off the reference marker on the active trace.  | :CALC{1-4}:MARK10   |

## Softkey Functions

### Marker Menu

| Key Operation              | Function   | SCPI Command                     |
|----------------------------|--|----------------------------------|
| <b>Marker</b>              | (Continued)  |                                  |
| <b>Clear Marker Menu</b>   |  |                                  |
| <b>Return</b>              | Returns to the softkey display screen one level higher.  |                                  |
| <b>Marker → Ref Marker</b> | Replaces the stimulus value of the reference marker with that of the active marker. As a result, the reference marker will be placed at the same position as the active marker.  | None                             |
| <b>Marker</b>              | (Continued)  |                                  |
| <b>Ref Marker Mode</b>     | Enables or disables the reference marker mode. When enabled, stimulus values and response values of markers 1 to 9 will be displayed using values relative to the reference marker. When disabled, the reference marker will not appear on the screen. | <b>:CALC{1-4};MARK{1-10};REF</b> |
| <b>Return</b>              | Returns to the “E5061A/E5062A Menu (Top Menu)” on page 322.  |                                  |



## Marker Function Menu

| Key Operation             | Function  | SCPI Command                             |
|---------------------------|---|--|
| <b>Marker Fctn</b>        | Displays softkeys for setting the sweep range, using markers and other marker options.  |  |
| <b>Marker → Start</b>     | Sets the starting frequency to the stimulus value of the active marker on the active trace. Even if the reference marker is enabled and a relative stimulus value is displayed, the absolute value will be used.  | :CALC{1-4}:MARK{1-10}:SET STAR           |
| <b>Marker → Stop</b>      | Sets the ending frequency to the stimulus value of the active marker on the active trace. Even if the reference marker is enabled and a relative stimulus value is displayed, the absolute value will be used.  | :CALC{1-4}:MARK{1-10}:SET STOP           |
| <b>Marker → Center</b>    | Sets the center frequency to the stimulus value of the active marker on the active trace. Even if the reference marker is enabled and a relative stimulus value is displayed, the absolute value will be used.  | :CALC{1-4}:MARK{1-10}:SET CENT           |
| <b>Marker → Reference</b> | Sets the value of the reference line to the response value of the active marker on the active trace. A softkey having the same function is also provided in “Scale Menu” on page 349.   | :CALC{1-4}:MARK{1-10}:SET RLEV           |
| <b>Marker → Delay</b>     | Sets the electrical delay to the value of the group delay at the position of the active marker (a value smoothed with the aperture of 20% regardless of the setting of smoothing).  | :CALC{1-4}:MARK{1-10}:SET DEL            |
| <b>Discrete</b>           | Enables or disables the discrete marker function. When enabled, the marker will be placed at the nearest measurement point from the specified marker stimulus value. When disabled, the marker will be placed at the point corresponding to the specified marker stimulus value (by interpolating gaps between measurement points). | :CALC{1-4}:MARK{1-10}:DISC               |
| <b>Couple</b>             | Enables or disables marker coupling. When enabled, marker settings and movements become effective for all traces on a channel. When disabled, marker settings and movements are done independently on each trace.   | :CALC{1-4}:MARK{1-10}:COUP               |
| <b>Marker Table</b>       | Enables or disables the marker table display. The marker table lists the values of markers for all traces defined on a channel using the bottom third of the screen. If a channel holds too many markers to be displayed in the display area, use the scroll bar on the right to view the entire table.                             | :DISP:TABL<br>:DISP:TABL:TYPE MARK       |
| <b>Statistics</b>         | Enables or disables the display of statistics. When enabled, the following three statistical data items (Mean value, Standard deviation, Peak-to-peak) will be displayed on the screen. For details, see “Determining the Mean, Standard Deviation, and p-p of the Trace” on page 150.  | :CALC{1-4}:MARK:MATH:STAT                |
| <b>Flatness</b>           | Enables or disables the display of flatness. When enabled, the span, gain, slope, and flatness between marker 1 and 2 will be displayed on the screen. For details, see “Obtaining Span, Gain, Slope, and Flatness between Markers” on page 151.  | :CALC{1-4}:MARK:MATH:FLAT                |
| <b>RF Filter Stats</b>    | Enables or disables the display of filter statistics. When enabled, loss, ripple, and attenuation of the filter will be displayed on the screen. For details, see “Obtaining Loss, Ripple, and Attenuation of the RF Filter” on page 152.   | :CALC{1-4}:MARK:MATH:FST                 |
| <b>Annotation Options</b> | Displays softkeys for appearance of the marker values that are displayed on the screen.   |  |
| <b>Marker Info X Pos</b>  | Specifies horizontal display position by the width of the display area as a percentage.   | :DISP{1-4}:WIND:TRAC{1-4}:ANN:MARK:POS:X |
| <b>Marker Info Y Pos</b>  | Specifies vertical display position by the height of the display area as a percentage.  | :DISP{1-4}:WIND:TRAC{1-4}:ANN:MARK:POS:Y |
| <b>Align</b>              | Enables or disables the mode to align the display position of the marker value for each trace to trace 1.   | :DISP:WIND{1-4}:ANN:MARK:ALIG            |
| <b>Active Only</b>        | Toggles on/off the display of marker values for active traces only.   | :DISP:WIND{1-4}:ANN:MARK:SING            |
| <b>Return</b>             | Returns to the “E5061A/E5062A Menu (Top Menu)” on page 322.   |  |

## Marker Search Menu

| Key Operation  | Function   | SCPI Command   |
|----------------|--|--|
| Marker Search  | Displays softkeys for performing searches using markers.   |  |
| Max            | Moves the active marker to a position on the trace that represents the maximum response value.   | :CALC{1-4}:MARK{1-10}:FUNC:EXEC<br>:CALC{1-4}:MARK{1-10}:FUNC:TYPE<br>MAX  |
| Min            | Moves the active marker to a position on the trace that represents the minimum response value.   | :CALC{1-4}:MARK{1-10}:FUNC:EXEC<br>:CALC{1-4}:MARK{1-10}:FUNC:TYPE<br>MIN  |
| Peak           | Displays softkeys for setting and performing a peak search. A peak refers to a point where the response value is larger (positive peak) or smaller (negative peak) than those of adjacent measurement points on either side in a rectangular display format. A peak search picks up points that satisfy definitions given by <b>Peak Excursion</b> and <b>Peak Polarity</b> among all the peaks. If the Smith chart format or polar format is used, the main response value, among the two response values, will be used to perform searches (e.g., resistance in the <b>Smith (R+jX)</b> format). |  |
| Search Peak    | In the rectangular display format, the active marker will move to the peak with maximum response value among the peaks that match the definition if the peak polarity is <b>Positive</b> or <b>Both</b> , or to the peak with minimum response value if the peak polarity is <b>Negative</b> . The search is performed based on conditions defined by <b>Peak Excursion</b> and <b>Peak Polarity</b> .   | :CALC{1-4}:MARK{1-10}:FUNC:EXEC<br>:CALC{1-4}:MARK{1-10}:FUNC:TYPE<br>PEAK |
| Search Left    | In a rectangular display format, moves the active marker to the peak on its left under the given conditions. The search is performed based on conditions defined by <b>Peak Excursion</b> and <b>Peak Polarity</b> .   | :CALC{1-4}:MARK{1-10}:FUNC:EXEC<br>:CALC{1-4}:MARK{1-10}:FUNC:TYPE<br>LPE  |
| Search Right   | In a rectangular display format, moves the active marker to the peak on its right under the given conditions. The search is performed based on conditions defined by <b>Peak Excursion</b> and <b>Peak Polarity</b> .  | :CALC{1-4}:MARK{1-10}:FUNC:EXEC<br>:CALC{1-4}:MARK{1-10}:FUNC:TYPE<br>RPE  |
| Peak Excursion | Sets the peak offset (and performs <b>Search Peak</b> at the same time). Peak offset is the difference between the response value of a peak and those of adjacent peaks of opposite polarity (the vertical interval between the tip and the base of a slope, one each on the left and right) in a rectangular display format. The smaller of the two will be used. The peak search will detect peaks with an offset larger than the set value.   | :CALC{1-4}:MARK{1-10}:FUNC:PEXC  |
| Peak Polarity  | Displays softkeys for selecting the polarity of peaks. A peak search will detect peaks having the matching polarity.   |  |
| Positive       | Selects positive polarity (and performs <b>Search Peak</b> at the same time). A positive peak is a point whose measured value is larger than the values of the two adjacent points on its left and right.  | :CALC{1-4}:MARK{1-10}:FUNC:PPOL<br>POS                                     |
| Negative       | Selects negative polarity (and performs <b>Search Peak</b> at the same time). A negative peak is a point whose measured value is smaller than the values of the two adjacent points on its left and right.   | :CALC{1-4}:MARK{1-10}:FUNC:PPOL<br>NEG                                     |
| Both           | Selects both positive and negative polarity (and performs <b>Search Peak</b> at the same time).  | :CALC{1-4}:MARK{1-10}:FUNC:PPOL<br>BOTH                                    |
| Cancel         | Returns to the softkey display screen one level higher.  |  |
| Return         | Returns to the softkey display screen one level higher.  |  |

| Key Operation            | Function   | SCPI Command   |
|--------------------------|--|--|
| Marker Search            | (Continued)  |  |
| <b>Target</b>            | Displays softkeys for setting and performing target searches. A target refers to a point on a trace that has a unique response value (target value) in a rectangular display format. A target search picks up points that have matching characteristics defined by <b>Target Value</b> and <b>Target Transition</b> . If the Smith chart format or polar format is used, the main response value, among the two response values, will be used to perform searches (e.g., resistance in the <b>Smith (R+<i>j</i>X)</b> format). |  |
| <b>Search Target</b>     | In a rectangular display format, moves the active marker to the nearest target (i.e., the closest stimulus value on the X-axis) that matches the definition (having a unique response value - the target value). The conditions for a target search must be defined using <b>Target Value</b> and <b>Target Transition</b> .   | :CALC{1-4}:MARK{1-10}:FUNC:EXEC<br>:CALC{1-4}:MARK{1-10}:FUNC:TYPE<br>TARG |
| <b>Search Left</b>       | In a rectangular display format, moves the active marker to the target that is nearest on its left and that matches the definition (having a unique response value - the target value). The conditions for a target search must be defined using <b>Target Value</b> and <b>Target Transition</b> .  | :CALC{1-4}:MARK{1-10}:FUNC:EXEC<br>:CALC{1-4}:MARK{1-10}:FUNC:TYPE<br>LTAR |
| <b>Search Right</b>      | In a rectangular display format, moves the active marker to the target that is nearest on its right and that matches the definition (having a unique response value - the target value). The conditions for a target search must be defined using <b>Target Value</b> and <b>Target Transition</b> .   | :CALC{1-4}:MARK{1-10}:FUNC:EXEC<br>:CALC{1-4}:MARK{1-10}:FUNC:TYPE<br>RTAR |
| <b>Target Value</b>      | Sets the target value (desired response value). (Also performs <b>Search Target</b> at the same time.) A target search uses the target value to look for a point on a trace.   | :CALC{1-4}:MARK{1-10}:FUNC:TARG  |
| <b>Target Transition</b> | Displays softkeys for defining the transition direction.   |  |
| <b>Positive</b>          | Selects positive transition for a target search (and performs <b>Search Target</b> at the same time). Targets with positive transition refer to points whose response value is larger than the value of the adjacent point on its left in a rectangular display format.  | :CALC{1-4}:MARK{1-10}:FUNC:TTR<br>POS                                      |
| <b>Negative</b>          | Selects negative transition for a target search (and performs <b>Search Target</b> at the same time). Targets with negative transition refer to points whose response value is larger than the value of the adjacent point on its left in a rectangular display format.  | :CALC{1-4}:MARK{1-10}:FUNC:TTR<br>NEG                                      |
| <b>Both</b>              | Selects both positive and negative transition for a target search (and performs <b>Search Target</b> at the same time).  | :CALC{1-4}:MARK{1-10}:FUNC:TTR<br>BOTH                                     |
| <b>Cancel</b>            | Returns to the softkey display screen one level higher.  |  |
| <b>Return</b>            | Returns to the softkey display screen one level higher.  |  |
| <b>Multi Peak</b>        | Displays softkeys for setting and performing a multi peak search.  |  |
| <b>Search Multi Peak</b> | In the rectangular display format, the markers will move to the peak with maximum response value among the peaks that match the definition if the peak polarity is <b>Positive</b> or <b>Both</b> , or to the peak with minimum response value if the peak polarity is <b>Negative</b> . The search is performed based on conditions defined by <b>Peak Excursion</b> and <b>Peak Polarity</b> .   | :CALC{1-4}:MARK:FUNC:MULT:TYPE<br>PEAK                                     |
| <b>Peak Excursion</b>    | Sets the peak offset (and performs <b>Search Peak</b> at the same time). Peak offset is the difference between the response value of a peak and those of adjacent peaks of opposite polarity (the vertical interval between the tip and the base of a slope, one each on the left and right) in a rectangular display format. The smaller of the two will be used. The peak search will detect peaks with an offset larger than the set value.   | :CALC{1-4}:MARK:FUNC:MULT:PEXC   |

Softkey Functions  
Marker Search Menu

| Key Operation       | Function   | SCPI Command  |
|---------------------|--|---|
| Marker Search       | (Continued)  |   |
| Multi Peak          |  |   |
| Peak Polarity       | Displays softkeys for selecting the polarity of peaks. A peak search will detect peaks having the matching polarity.   |   |
| Positive            | Selects positive polarity (and performs <b>Search Multi Peak</b> at the same time). A positive peak is a point whose measured value is larger than the values of the two adjacent points on its left and right.  | :CALC{1-4}:MARK:FUNC:MULT:PPOL<br>POS                                       |
| Negative            | Selects negative polarity (and performs <b>Search Multi Peak</b> at the same time). A negative peak is a point whose measured value is smaller than the values of the two adjacent points on its left and right.   | :CALC{1-4}:MARK:FUNC:MULT:PPOL<br>NEG                                       |
| Both                | Selects both positive and negative polarity (and performs <b>Search Multi Peak</b> at the same time).  | :CALC{1-4}:MARK:FUNC:MULT:PPOL<br>BOTH                                      |
| Cancel              | Returns to the softkey display screen one level higher.  |   |
| Return              | Returns to the softkey display screen one level higher.  |   |
| Multi Target        | Displays softkeys for setting and performing multi target searches.  |   |
| Search Multi Target | In a rectangular display format, moves the markers to the nearest target (i.e., the closest stimulus value on the X-axis) that matches the definition (having a unique response value - the target value). The conditions for a target search must be defined using <b>Target Value</b> and <b>Target Transition</b> . | :CALC{1-4}:MARK:FUNC:MULT:TYPE<br>TARG                                      |
| Target Value        | Sets the target value (desired response value). A multi target search uses the target value to look for a point on a trace.  | :CALC{1-4}:MARK:FUNC:MULT:TAR<br>G  |
| Target Transition   | Displays softkeys for defining the transition direction.   |   |
| Positive            | Selects positive transition for a target search (and performs <b>Search Multi Target</b> at the same time). Targets with positive transition refer to points whose response value is larger than the value of the adjacent point on its left in a rectangular display format.  | :CALC{1-4}:MARK:FUNC:MULT:TTR<br>POS  |
| Negative            | Selects negative transition for a target search (and performs <b>Search Multi Target</b> at the same time). Targets with negative transition refer to points whose response value is larger than the value of the adjacent point on its left in a rectangular display format.  | :CALC{1-4}:MARK:FUNC:MULT:TTR<br>NEG  |
| Both                | Selects both positive and negative transition for a target search (and performs <b>Search Multi Target</b> at the same time).  | :CALC{1-4}:MARK:FUNC:MULT:TTR<br>BOTH                                       |
| Cancel              | Returns to the softkey display screen one level higher.  |   |
| Return              | Returns to the softkey display screen one level higher.  |   |
| Tracking            | Enables or disables search tracking. When enabled, the currently selected search operation will be performed each time a sweep is completed. If disabled, you can initiate a search by pressing a key for a particular search.   | :CALC{1-4}:MARK{1-10}:FUNC:TRAC<br>:CALC{1-4}:MARK{1-10}:FUNC:MULT:<br>TRAC |

| Key Operation          | Function   | SCPI Command                   |
|------------------------|--|--------------------------------|
| Marker Search          | (Continued)  |                                |
| <b>Search Range</b>    | Displays softkeys for setting the search range of the maximum, minimum, peak and target search.  |                                |
| <b>Search Range</b>    | Enables or disables partial search feature.  | :CALC{1-4}:MARK:FUNC:DOM       |
| <b>Start</b>           | Sets start value (lower limit) of the search range.  | :CALC{1-4}:MARK:FUNC:DOM:STAR  |
| <b>Stop</b>            | Sets stop value (upper limit) of the search range.   | :CALC{1-4}:MARK:FUNC:DOM:STOP  |
| <b>Couple</b>          | Enables or disables trace coupling within search range.  | :CALC{1-4}:MARK:FUNC:DOM:COUP  |
| <b>Return</b>          | Returns to the softkey display screen one level higher.  |                                |
| <b>Bandwidth</b>       | Enables or disables bandwidth searching. When enabled, bandwidth parameters (Insertion loss, Low cutoff point, High cutoff point, Center frequency, Bandwidth and Q) will be displayed on the screen. If the Smith chart format or polar format is used, the main response value, among the two response values, will be used to perform searches (e.g., resistance in the <b>Smith (R+jX)</b> format). For details, see “Determining the Bandwidth of the Trace (Bandwidth Search)” on page 146.                                      | :CALC{1-4}:MARK{1-10}:BWID     |
| <b>Bandwidth Value</b> | Sets the bandwidth. The bandwidth in a bandwidth search is defined by specifying the displacement from the active marker to the cutoff point using the response value (the value assigned to the Y-axis in a rectangular display format).  | :CALC{1-4}:MARK{1-10}:BWID:THR |
| <b>Notch</b>           | Toggles on/off the notch search. When the notch search is on, the notch parameters (insertion loss, lower cutoff point, higher cutoff point, center value, bandwidth, and Q) are displayed on the screen. When the data format is the Smith chart or the polar format, the primary response value (for example, resistance value for the <b>Smith (R+jX)</b> format) out of the two response values is chosen as a target to search.<br><br>For more information, see “Obtaining the bandwidth of a trace (notch search)” on page 148. | :CALC{1-4}:MARK{1-10}:NOTC     |
| <b>Notch Value</b>     | Sets the notch value. Define a response value distance (distance in the Y-axis direction in the rectangular display format) from the active marker position to the cutoff point for the notch search.  | :CALC{1-4}:MARK{1-10}:NOTC:THR |
| <b>Return</b>          | Returns to the “E5061A/E5062A Menu (Top Menu)” on page 322.  |                                |

---

## Measurement Menu

| Key Operation | Function   | SCPI Command                       |
|---------------|--|------------------------------------|
| <b>Meas</b>   | Displays softkeys for setting measurement parameters. These softkeys will not be displayed unless either the balanced/unbalanced conversion function or the fixture simulator function is turned off ( <b>BalUn OFF</b> or <b>Fixture Simulator OFF</b> ) in the “Analysis Menu” on page 323 on the E5061A/E5062A. |                                    |
| <b>S11</b>    | Selects parameter $S_{11}$ .   | <b>:CALC{1-4}:PAR{1-4}:DEF S11</b> |
| <b>S21</b>    | Selects parameter $S_{21}$ .   | <b>:CALC{1-4}:PAR{1-4}:DEF S21</b> |
| <b>S12</b>    | Selects parameter $S_{12}$ .   | <b>:CALC{1-4}:PAR{1-4}:DEF S12</b> |
| <b>S22</b>    | Selects parameter $S_{22}$ .   | <b>:CALC{1-4}:PAR{1-4}:DEF S22</b> |
| <b>Return</b> | Returns to the “E5061A/E5062A Menu (Top Menu)” on page 322.  |                                    |

## Preset Menu

| Key Operation | Function  | SCPI Command      |
|---------------|---|-------------------|
| <b>Preset</b> | Displays softkeys for restoring the preset conditions.  |                   |
| <b>OK</b>     | Restores the preset conditions. May not be displayed, depending on the preset settings.                             | <b>:SYST:PRES</b> |
| <b>Cancel</b> | Returns to the “E5061A/E5062A Menu (Top Menu)” on page 322. May not be displayed, depending on the preset settings. |                   |

## Save/Recall Menu

| Key Operation       | Function  | SCPI Command                |
|---------------------|---|-----------------------------|
| Save/Recall         | Displays softkeys for saving and recalling data.  |                             |
| <b>Save State</b>   | Displays softkeys for saving settings.  |                             |
| State01             | Saves the current settings on the internal hard disk drive (D:) and names it State01.sta.   | :MMEM:STOR<br>"State01.sta" |
| State02             | Saves the current settings on the internal hard disk drive (D:) and names it State02.sta.   | :MMEM:STOR<br>"State02.sta" |
| State03             | Saves the current settings on the internal hard disk drive (D:) and names it State03.sta.   | :MMEM:STOR<br>"State03.sta" |
| State04             | Saves the current settings on the internal hard disk drive (D:) and names it State04.sta.   | :MMEM:STOR<br>"State04.sta" |
| State05             | Saves the current settings on the internal hard disk drive (D:) and names it State05.sta.   | :MMEM:STOR<br>"State05.sta" |
| State06             | Saves the current settings on the internal hard disk drive (D:) and names it State06.sta.   | :MMEM:STOR<br>"State06.sta" |
| State07             | Saves the current settings on the internal hard disk drive (D:) and names it State07.sta.   | :MMEM:STOR<br>"State07.sta" |
| State08             | Saves the current settings on the internal hard disk drive (D:) and names it State08.sta.   | :MMEM:STOR<br>"State08.sta" |
| Autorec             | Saves the current settings on the internal hard disk drive (D:) and names it Autorec.sta. This file will be automatically loaded during the startup process and the analyzer settings will be restored. | :MMEM:STOR<br>"Autorec.sta" |
| File Dialog...      | Opens a dialog box for saving settings. This dialog box allows the user to save settings with an arbitrary name. This key is also used to save settings to a floppy disk.                               | :MMEM:STOR                  |
| Return              | Returns to the softkey display screen one level higher.   |                             |
| <b>Recall State</b> | Displays softkeys for recalling settings.   |                             |
| State01             | Recalls from the internal hard disk drive (D:) the settings saved as State01.sta.   | :MMEM:LOAD<br>"State01.sta" |
| State02             | Recalls from the internal hard disk drive (D:) the settings saved as State02.sta.   | :MMEM:LOAD<br>"State02.sta" |
| State03             | Recalls from the internal hard disk drive (D:) the settings saved as State03.sta.   | :MMEM:LOAD<br>"State03.sta" |
| State04             | Recalls from the internal hard disk drive (D:) the settings saved as State04.sta.   | :MMEM:LOAD<br>"State04.sta" |
| State05             | Recalls from the internal hard disk drive (D:) the settings saved as State05.sta.   | :MMEM:LOAD<br>"State05.sta" |
| State06             | Recalls from the internal hard disk drive (D:) the settings saved as State06.sta.   | :MMEM:LOAD<br>"State06.sta" |
| State07             | Recalls from the internal hard disk drive (D:) the settings saved as State07.sta.   | :MMEM:LOAD<br>"State07.sta" |
| State08             | Recalls from the internal hard disk drive (D:) the settings saved as State08.sta.   | :MMEM:LOAD<br>"State08.sta" |
| Autorec             | Recalls from the internal hard disk drive (D:) the settings saved as Autorec.sta.   | :MMEM:LOAD<br>"Autorec.sta" |
| File Dialog...      | Opens a dialog box for recalling settings. This dialog box allows the user to recall settings saved under arbitrary names. This key is also used to recall a file saved on a floppy disk.               | :MMEM:LOAD                  |



| Key Operation              | Function   | SCPI Command               |
|----------------------------|--|----------------------------|
| <b>Save/Recall</b>         | (Continued)  |                            |
| <b>Recall State</b>        |  |                            |
| <b>Return</b>              | Returns to the softkey display screen one level higher.  |                            |
| <b>Recall by File Name</b> | Displays softkeys that show the state file names for recalling settings.   |                            |
| <b>(File Name 1)</b>       | Recalls from the internal hard disk drive (D:\State) the settings saved as the filename used in the softkel label. | :MMEM:LOAD                 |
| <b>(File Name 2)</b>       | Recalls from the internal hard disk drive (D:\State) the settings saved as the filename used in the softkel label. | :MMEM:LOAD                 |
| :                          | :  |                            |
| <b>Return</b>              | Returns to the softkey display screen one level higher.  |                            |
| <b>Save Channel</b>        | Displays softkeys for saving settings for each channel into registers A to D (volatile memory).                    |                            |
| <b>State A</b>             | Saves the current settings for each channel into registers A.  | :MMEM:STOR:CHAN A          |
| <b>State B</b>             | Saves the current settings for each channel into registers B.  | :MMEM:STOR:CHAN B          |
| <b>State C</b>             | Saves the current settings for each channel into registers C.  | :MMEM:STOR:CHAN C          |
| <b>State D</b>             | Saves the current settings for each channel into registers D.  | :MMEM:STOR:CHAN D          |
| <b>Cal Only A</b>          | Saves the calibration data for each channel into registers A.  | :MMEM:STOR:CHAN:C<br>OEF A |
| <b>Cal Only B</b>          | Saves the calibration data for each channel into registers B.  | :MMEM:STOR:CHAN:C<br>OEF B |
| <b>Cal Only C</b>          | Saves the calibration data for each channel into registers C.  | :MMEM:STOR:CHAN:C<br>OEF C |
| <b>Cal Only D</b>          | Saves the calibration data for each channel into registers D.  | :MMEM:STOR:CHAN:C<br>OEF D |
| <b>Clear States</b>        | Displays softkeys for clearing registers.  |                            |
| <b>OK</b>                  | Clears all registers (A - D).  | :MMEM:STOR:CHAN:C<br>LE    |
| <b>Cancel</b>              | Returns to the softkey display screen one level higher.  |                            |
| <b>Return</b>              | Returns to the softkey display screen one level higher.  |                            |
| <b>Recall Channel</b>      | Displays softkeys for recalling settings for each channel from registers A to D (volatile memory).                 |                            |
| <b>State A</b>             | Recalls the current settings for each channel from registers A.  | :MMEM:LOAD:CHAN A          |
| <b>State B</b>             | Recalls the current settings for each channel from registers B.  | :MMEM:LOAD:CHAN B          |
| <b>State C</b>             | Recalls the current settings for each channel from registers C.  | :MMEM:LOAD:CHAN C          |
| <b>State D</b>             | Recalls the current settings for each channel from registers D.  | :MMEM:LOAD:CHAN D          |
| <b>Cal Only A</b>          | Recalls the calibration data for each channel from registers A.  | :MMEM:LOAD:CHAN:C<br>OEF A |
| <b>Cal Only B</b>          | Recalls the calibration data for each channel from registers B.  | :MMEM:LOAD:CHAN:C<br>OEF B |
| <b>Cal Only C</b>          | Recalls the calibration data for each channel from registers C.  | :MMEM:LOAD:CHAN:C<br>OEF C |
| <b>Cal Only D</b>          | Recalls the calibration data for each channel from registers D.  | :MMEM:LOAD:CHAN:C<br>OEF D |
| <b>Return</b>              | Returns to the softkey display screen one level higher.  |                            |
| <b>Save Type</b>           | Displays softkeys for selecting the types of data to be saved.   |                            |
| <b>State Only</b>          | Saves settings only.   | :MMEM:STOR:STYP<br>STAT    |
| <b>State &amp; Cal</b>     | Saves settings and calibration data.   | :MMEM:STOR:STYP<br>CST     |

Softkey Functions  
**Save/Recall Menu**

| Key Operation   | Function  | SCPI Command                          |
|-----------------|---|---------------------------------------|
| Save/Recall     | (Continued)   |                                       |
| Save Type       |   |                                       |
| State & Trace   | Saves settings and trace data.  | :MMEM:STOR:STYP<br>DST                |
| All             | Saves settings, calibration data, and trace data.   | :MMEM:STOR:STYP<br>CDST               |
| Cancel          | Returns to the softkey display screen one level higher.   |                                       |
| Channel/Trace   | Selects the save target for saving settings from all channels/traces ( <b>All</b> ) or displayed channel/traces only ( <b>Disp Only</b> ).  | :MMEM:STOR:STYP<br>SALL               |
| Save Trace Data | Opens a dialog box for saving trace data as a CSV (comma-separated value) file. A CSV file can be opened in spreadsheet software such as Microsoft® Excel®.   | :MMEM:STOR:FDAT                       |
| Explorer...     | Opens Windows Explorer for organizing (cut, copy, paste, delete, rename, format) files and folders. The operation is same as Windows 98 computers. Users can modify files and folders in drive A: (floppy disk drive) and drive D: (user directory). Be sure not to modify any files and folders in drives other than drive A: and drive D:.. Doing so will cause malfunctions. | :MMEM:MDIR<br>:MMEM:COPY<br>:MMEM:DEL |
| Return          | Returns to the "E5061A/E5062A Menu (Top Menu)" on page 322.   |                                       |

## Scale Menu

| Key Operation             | Function   | SCPI Command                               |
|---------------------------|--|--|
| <b>Scale</b>              | Displays softkeys for adjusting scales.  |  |
| <b>Auto Scale</b>         | Automatically adjusts scales for the active trace.   | :DISP:WIND{1-4}:TRAC{1-4}:Y:AUTO           |
| <b>Auto Scale All</b>     | Automatically adjusts scales for all traces within the active channel.   | None                                       |
| <b>Divisions</b>          | Defines the number of divisions on the Y-axis of a rectangular display format. An even number from 4 to 30 must be used. Once set, it is then applied to all traces displayed in any rectangular display format within that channel.   | :DISP:WIND{1-4}:TRAC{1-4}:Y:DIV            |
| <b>Scale/Div</b>          | In a rectangular format, defines the number of increments per division on the Y-axis. In the Smith chart format or polar format, defines the range (the displacement of the outermost circle). The setting applies to the active trace only.   | :DISP:WIND{1-4}:TRAC{1-4}:Y:PDIV           |
| <b>Reference Position</b> | Defines the position of the reference line on a rectangular display format. The position must be defined by using numbers assigned to the Y-axis between 0 (the origin, the X-axis) and the number of divisions (the highest scale). This setting applies only to the active trace. The reference line can also be moved by performing a drag-and-drop operation (pressing the mouse button on the object to be moved and releasing the button after dragging it to the desired position) on one of the reference line pointers (▶ and ◀). | :DISP:WIND{1-4}:TRAC{1-4}:Y:RPOS           |
| <b>Reference Value</b>    | Defines the value corresponding to the reference line on a rectangular display format. The setting applies only to the active trace.   | :DISP:WIND{1-4}:TRAC{1-4}:Y:RLEV           |
| <b>Reference Tracking</b> | Displays the menu to execute the reference tracking function.  |  |
| <b>Track Frequency</b>    | Sets a frequency to be tracked.  | :DISP:WIND{1-4}:TRAC{1-4}:Y:TRAC:FREQ      |
| <b>Tracking</b>           | Displays the softkeys to set the tracking function.  |  |
| <b>OFF</b>                | Turns off the tracking function.   | :DISP:WIND{1-4}:TRAC{1-4}:Y:TRAC:MODE OFF  |
| <b>Track Peak</b>         | Uses the peak value for tracking.  | :DISP:WIND{1-4}:TRAC{1-4}:Y:TRAC:MODE PEAK |
| <b>Track Freq</b>         | Uses a specified frequency for tracking.   | :DISP:WIND{1-4}:TRAC{1-4}:Y:TRAC:MODE FREQ |
| <b>Marker → Reference</b> | Changes the value of the reference line to the response value of the active marker. The same function is also accessible from the “Marker Function Menu” on page 339.  | :CALC{1-4}:MARK{1-10}:SET:RLEV             |
| <b>Electrical Delay</b>   | Sets an electrical delay to the active trace. This function simulates the addition or deletion of a variable length lossless transfer line against the input of a receiver. It can be used to compensate for the electrical length of cables inside the DUT. Although the unit used is seconds, the length (meters) will be displayed in parentheses next to the input box based on the velocity coefficient used at the time.   | :CALC{1-4}:CORR:EDEL:TIME                  |
| <b>Phase Offset</b>       | Sets the values to be added or subtracted in phase measurement (phase offset) (°).   | :CALC{1-4}:CORR:OFFS:PHAS                  |
| <b>Return</b>             | Returns to the “E5061A/E5062A Menu (Top Menu)” on page 322.  |  |

## Stimulus Menu

| Key Operation                         | Function  | SCPI Command                |
|---------------------------------------|---|-----------------------------|
| <input type="button" value="Start"/>  | Sets the lowest frequency for sweeps.<br>Also displays a menu (Stimulus Menu) for defining the sweep range.                     | <b>:SENS{1-4}:FREQ:STAR</b> |
| <input type="button" value="Start"/>  | Sets the starting frequency for sweeps.   | <b>:SENS{1-4}:FREQ:STAR</b> |
| <input type="button" value="Stop"/>   | Sets the ending frequency for sweeps.   | <b>:SENS{1-4}:FREQ:STOP</b> |
| <input type="button" value="Center"/> | Sets the center frequency of the sweep range.   | <b>:SENS{1-4}:FREQ:CENT</b> |
| <input type="button" value="Span"/>   | Sets the frequency span for sweeps.   | <b>:SENS{1-4}:FREQ:SPAN</b> |
| <input type="button" value="Return"/> | Returns to the "E5061A/E5062A Menu (Top Menu)" on page 322.   |                             |
| <input type="button" value="Stop"/>   | Sets the ending frequency for sweeps.<br>Also displays the Stimulus Menu same as <input type="button" value="Start"/> .         | <b>:SENS{1-4}:FREQ:STOP</b> |
| <input type="button" value="Center"/> | Sets the center frequency of the sweep range.<br>Also displays the Stimulus Menu same as <input type="button" value="Start"/> . | <b>:SENS{1-4}:FREQ:CENT</b> |
| <input type="button" value="Span"/>   | Sets the frequency span for sweeps.<br>Also displays the Stimulus Menu same as <input type="button" value="Start"/> .           | <b>:SENS{1-4}:FREQ:SPAN</b> |

## Sweep Setup Menu

| Key Operation                     | Function  | SCPI Command                                    |
|-----------------------------------|---|---|
| <b>Sweep Setup</b>                | Displays softkeys for setting up sweeps.  |   |
| <b>Power</b>                      | Displays the menu to set the stimulus signal output.  |   |
| <b>Power</b>                      | Sets the output power level of the internal signal source of the analyzer.  | :SOUR{1-4}:POW                                  |
| <b>Power Ranges</b> <sup>*1</sup> | Displays softkeys for selecting the power range.  |   |
| <b>-5 to 10</b>                   | Sets the power range to -5 dBm to 10 dBm.   | :SOUR{1-4}:POW:ATT 0                            |
| <b>-15 to 0</b>                   | Sets the power range to -15 dBm to 0 dBm.   | :SOUR{1-4}:POW:ATT 10                           |
| <b>-25 to -10</b>                 | Sets the power range to -25 dBm to -10 dBm.   | :SOUR{1-4}:POW:ATT 20                           |
| <b>-35 to -20</b>                 | Sets the power range to -35 dBm to -20 dBm.   | :SOUR{1-4}:POW:ATT 30                           |
| <b>-45 to -30</b>                 | Sets the power range to -45 dBm to -30 dBm.   | :SOUR{1-4}:POW:ATT 40                           |
| <b>Cancel</b>                     | Returns to the softkey display screen one level higher.   |   |
| <b>Port Couple</b>                | Turns on/off the port coupling for the power level.   | :SOUR{1-4}:POW:PORT:COUP                        |
| <b>Port Power</b>                 | Displays the softkey to set the power level for each port when the port coupling is off.  |   |
| <b>Port 1 Power</b>               | Sets the power level of port 1.   | :SOUR{1-4}:POW:PORT1                            |
| <b>Port 2 Power</b>               | Sets the power level of port 2.   | :SOUR{1-4}:POW:PORT2                            |
| <b>Slope [xx dB/GHz]</b>          | Sets the correction coefficient (correction amount of power level per 1 GHz) when the power slope feature is on.  | :SOUR{1-4}:POW:SLOP                             |
| <b>Slope [ON/OFF]</b>             | Turns on/off of the power slope feature.  | :SOUR{1-4}:POW:SLOP:STAT                        |
| <b>CW Freq</b>                    | Sets the fixed frequency for the power sweep.   | :SENS{1-4}:FREQ                                 |
| <b>RF Out</b>                     | Turns on/off of the stimulus signal output.   | :OUTP   |
| <b>Return</b>                     | Returns to the softkey display screen one level higher.   |   |
| <b>Sweep Time</b>                 | Sets the sweep time for each source port. Inputting the value "0" as the sweep time causes the analyzer to go into automatic sweep time mode.   | :SENS{1-4}:SWE:TIME<br>:SENS{1-4}:SWE:TIME:AUTO |
| <b>Sweep Delay</b>                | Sets the wait (delay) time before starting a sweep for each source port.  | :SENS{1-4}:SWE:DEL                              |
| <b>Points</b>                     | Sets the number of points per sweep. The number of points should be from 2 to 1601.   | :SENS{1-4}:SWE:POIN                             |
| <b>Sweep Type</b>                 | Displays softkeys for selecting the sweep type.   |   |
| <b>Lin Freq</b>                   | Selects linear frequency sweep.   | :SENS{1-4}:SWE:TYPE LIN                         |
| <b>Log Freq</b>                   | Selects logarithmic frequency sweep.  | :SENS{1-4}:SWE:TYPE LOG                         |
| <b>Segment</b>                    | Selects segment sweep.  | :SENS{1-4}:SWE:TYPE SEG                         |
| <b>Power Sweep</b>                | Selects power sweep.  | :SENS{1-4}:SWE:TYPE POW                         |
| <b>Cancel</b>                     | Returns to the softkey display screen one level higher.   |   |
| <b>Edit Segment Table</b>         | Displays the segment sweep setup table as well as softkeys for editing the segment table.   |   |
| <b>Freq Mode</b>                  | Alternates the setup mode for the sweep range between two methods: one using the starting and ending frequencies ( <b>Start/Stop</b> ), and the other using the center frequency and a frequency span ( <b>Center/Span</b> ). | :SENS{1-4}:SEGM:DATA                            |
| <b>List IFBW</b>                  | Enables or disables the IF bandwidth display in the segment table.  | :SENS{1-4}:SEGM:DATA                            |
| <b>List Power</b>                 | Enables or disables the power level display in the segment table.   | :SENS{1-4}:SEGM:DATA                            |
| <b>List Delay</b>                 | Enables or disables the segment delay display in the segment table.   | :SENS{1-4}:SEGM:DATA                            |
| <b>List Time</b>                  | Enables or disables the segment sweep time display in the segment table.  | :SENS{1-4}:SEGM:DATA                            |
| <b>Delete</b>                     | Deletes from the segment table the segment upon which the cursor is currently located. If the cursor is not displayed, the segment on the bottom will be deleted.   | :SENS{1-4}:SEGM:DATA                            |

## Softkey Functions Sweep Setup Menu

| Key Operation        | Function   | SCPI Command   |
|----------------------|--|--|
| Sweep Setup          | (Continued)  |  |
| Edit Segment Table   |  |  |
| Add                  | Adds a new segment immediately above the segment upon which the cursor is currently located. If the cursor is not displayed, a new segment will be added to the bottom of the table.   | :SENS{1-4}:SEGM:DATA   |
| Clear Segment Table  | Displays softkeys for clearing elements of the segment table.  |  |
| OK                   | Deletes all segments in the segment table.   | None   |
| Cancel               | Returns to the softkey display screen one level higher.  |  |
| Export to CSV File   | Exports (saves data in file formats used by other software) the segment table as a CSV (comma-separated value) file.   | :MMEM:STOR:SEGM  |
| Import from CSV File | Imports (loads a file that is written in a format used by other software) a CSV (comma-separated value) file to the segment table of E5061A/E5062A.  | :MMEM:LOAD:SEGM  |
| Return               | Returns to the softkey display screen one level higher.  |  |
| Segment Display      | Selects linear frequency ( <b>Freq Base</b> ) or selects the order of measurements (1, 2, ..., N; where N refers to the number of points) ( <b>Order Base</b> ) for drawing the X-axis of a rectangular display format in a segment sweep. | :DISP:WIND{1-4}:X:SPAC LIN<br>:DISP:WIND{1-4}:X:SPAC<br>OBAS |
| Return               | Returns to the "E5061A/E5062A Menu (Top Menu)" on page 322.  |  |

\*1. Only with Options 1E1.

## System Menu

| Key Operation                          | Function   | SCPI Command                 |
|--|--|------------------------------|
| <b>System</b>                          | Displays softkeys for performing limit tests and accessing control and management functions on the analyzer.   |                              |
| <b>Print</b>                           | Outputs the current screen to a printer.   | :HCOP                        |
| <b>Abort Printing</b>                  | Aborts printing.   | :HCOP:ABOR                   |
| <b>Printer Setup</b>                   | Opens a dialog box for setting up the printer.   | None                         |
| <b>Invert Image</b>                    | Inverts the colors of the screen display.  | :HCOP:IMAG                   |
| <b>Dump Screen Image</b>               | Opens a dialog box for saving the screen image in BMP (Windows or OS/2 bitmap) format.   | :MMEM:STOR:IMAG              |
| <b>87050/75 Setup</b>                  | Displays the softkeys for the settings to control the 87050/87075.   |                              |
| <b>87050/75 Control</b>                | Toggles on/off the control of the 87050/87075.   | :SENS{1-4}:MULT              |
| <b>Reflection</b>                      | Displays the softkeys for the reflection-side port.  |                              |
| <b>Port 1</b>                          | Sets the reflection-side port to port 1.   | :SENS{1-4}:MULT:PORT1:SEL 1  |
| :                                      | :  | :                            |
| <b>Port 12</b>                         | Sets the reflection-side port to port 12.  | :SENS{1-4}:MULT:PORT1:SEL 12 |
| <b>Transmission</b>                    | Displays the softkeys for the transmission-side port.  |                              |
| <b>Port 1</b>                          | Sets the transmission-side port to port 1.   | :SENS{1-4}:MULT:PORT2:SEL 1  |
| :                                      | :  | :                            |
| <b>Port 12</b>                         | Sets the transmission-side port to port 12.  | :SENS{1-4}:MULT:PORT2:SEL 12 |
| <b>Property</b>                        | Toggles on/off the display of the 87050/87075 properties.  | :SENS{1-4}:MULT:PROP         |
| <b>Return</b>                          | Returns to the softkey display in one upper level.   |                              |
| <b>Misc Setup</b>                      | Displays softkeys for setting up the beeper function, GPIB, Network, internal clock, key lock function and color of display image.                                   |                              |
| <b>Beeper</b>                          | Displays softkeys for setting up the beeper function.  |                              |
| <b>Beep Complete</b>                   | Enables or disables beeps at the end of processes. When enabled, the user will be notified with a beep when a measurement has completed or settings have been saved. | :SYST:BEEP:COMP:STAT         |
| <b>Test Beep Complete</b>              | Tests the beeping sound.   | :SYST:BEEP:COMP:IMM          |
| <b>Beep Warning</b>                    | Enables or disables warning beeps. When enabled, all warning messages will be accompanied by beeps.  | :SYST:BEEP:WARN:STAT         |
| <b>Test Beep Warning</b>               | Tests the beeping sound for warnings.  | :SYST:BEEP:WARN:IMM          |
| <b>Return</b>                          | Returns to the softkey display screen one level higher.  |                              |
| <b>GPIB Setup</b>                      | Displays softkeys for setting up the GPIB.   |                              |
| <b>Talker/Listener Address</b>         | Sets the address for controlling the analyzer from a controller via GPIB.  | None                         |
| <b>System Controller Configuration</b> | Opens a dialog box for configuring the system controller (USB/GPIB interface).   | None                         |
| <b>Return</b>                          | Returns to the softkey display screen one level higher.  |                              |
| <b>Network Setup</b>                   | Displays softkeys for configuring network settings.  |                              |
| <b>Telnet Server</b>                   | Enables or disables the telnet server function.  | None                         |
| <b>SICL-LAN Server</b>                 | Enables or disables the SICL-LAN server function.  | None                         |
| <b>SICL-LAN Address</b>                | Sets the address for controlling the analyzer from a controller via SICL-LAN.  | None                         |

## Softkey Functions System Menu

| Key Operation                          | Function  | SCPI Command              |
|--|---|---------------------------|
| <b>System</b>                          | (Continued)   |                           |
| <b>Misc Setup</b>                      |   |                           |
| <b>Network Setup</b>                   |   |                           |
| <b>Web Server</b>                      | Toggles on/off the web server function of this instrument.  | None                      |
| <b>VNC Server Configuration...</b>     | Opens a window to set up the virtual network computer of this instrument.   | None                      |
| <b>Network Identification</b>          | Opens a dialog box for configuring the analyzer's identification such as a computer name.   | None                      |
| <b>Network Configuration</b>           | Opens a window for configuring network settings.  | None                      |
| <b>Return</b>                          | Returns to the softkey display screen one level higher.   |                           |
| <b>Clock Setup</b>                     | Displays softkeys for setting the internal clock.   |                           |
| <b>Set Date and Time</b>               | Opens a dialog box for setting the date and time of the internal clock.   | :SYST:DATE<br>:SYST:TIME  |
| <b>Show Clock</b>                      | Enables or disables the time and date display inside the status bar.  | :DISP:CLOC                |
| <b>Return</b>                          | Returns to the softkey display screen one level higher.   |                           |
| <b>Key Lock</b>                        | Displays softkeys for locking the keyboard and the mouse.   |                           |
| <b>Front Panel &amp; Keyboard Lock</b> | Locks the front panel keys and the keyboard (key operations disabled).  | :SYST:KLOC:KBD            |
| <b>Touch Screen &amp; Mouse Lock</b>   | Locks the touch screen and the mouse (mouse operations disabled).   | :SYST:KLOC:MOUS           |
| <b>Return</b>                          | Returns to the softkey display screen one level higher.   |                           |
| <b>Color Setup</b>                     | Displays softkeys for setting up the color of display image.  |                           |
| <b>Normal</b>                          | Displays softkeys for setting up the color of the normal display.   |                           |
| <b>Data Trace 1</b>                    | Displays softkeys for setting up the color of the data trace of Trace 1.  |                           |
| <b>Red</b>                             | Displays softkeys for setting up the amount of red in a color.  |                           |
| <b>0</b>                               | Sets 0.   | :DISP:COL{1-2}:TRAC1:DATA |
| <b>1</b>                               | Sets 1.   | :DISP:COL{1-2}:TRAC1:DATA |
| <b>:</b>                               | :   | :                         |
| <b>5</b>                               | Sets 5.   | :DISP:COL{1-2}:TRAC1:DATA |
| <b>Cancel</b>                          | Returns to the softkey display screen one level higher.   |                           |
| <b>Green</b>                           | Displays softkeys for setting up the amount of green in a color. The lower-level softkeys are the same as those for <b>Red</b> .                    |                           |
| <b>Blue</b>                            | Displays softkeys for setting up the amount of blue in a color. The lower-level softkeys are the same as those for <b>Red</b> .                     |                           |
| <b>Return</b>                          | Returns to the softkey display screen one level higher.   |                           |
| <b>Data Trace 2</b>                    | Displays softkeys for setting up the color of the data trace of Trace 2. The lower-level softkeys are the same as those for <b>Data Trace 1</b> .   | :DISP:COL{1-2}:TRAC2:DATA |
| <b>:</b>                               | :   | :                         |
| <b>Data Trace 4</b>                    | Displays softkeys for setting up the color of the data trace of Trace 4. The lower-level softkeys are the same as those for <b>Data Trace 1</b> .   | :DISP:COL{1-2}:TRAC4:DATA |
| <b>Mem Trace 1</b>                     | Displays softkeys for setting up the color of the memory trace of Trace 1. The lower-level softkeys are the same as those for <b>Data Trace 1</b> . | :DISP:COL{1-2}:TRAC1:MEM  |
| <b>:</b>                               | :   | :                         |
| <b>Mem Trace 4</b>                     | Displays softkeys for setting up the color of the memory trace of Trace 4. The lower-level softkeys are the same as those for <b>Data Trace 1</b> . | :DISP:COL{1-2}:TRAC4:MEM  |



| Key Operation     | Function   | SCPI Command         |
|-------------------|--|----------------------|
| System            | (Continued)  |                      |
| Misc Setup        |  |                      |
| Color Setup       |  |                      |
| Normal            |  |                      |
| Graticule Main    | Displays softkeys for setting up the color of the graticule labels and the outer frame of graphs. The lower-level softkeys are the same as those for <b>Data Trace 1</b> . | :DISP:COL{1-2}:GRAT1 |
| Graticule Sub     | Displays softkeys for setting up the color of the graticule lines in graphs. The lower-level softkeys are the same as those for <b>Data Trace 1</b> .                      | :DISP:COL{1-2}:GRAT2 |
| Limit Fail        | Displays softkeys for setting up the color of the fail label of the limit test. The lower-level softkeys are the same as those for <b>Data Trace 1</b> .                   | :DISP:COL{1-2}:LIM1  |
| Limit Line        | Displays softkeys for setting up the color of the limit line of the limit test. The lower-level softkeys are the same as those for <b>Data Trace 1</b> .                   | :DISP:COL{1-2}:LIM2  |
| Background        | Displays softkeys for setting up the color of the background. The lower-level softkeys are the same as those for <b>Data Trace 1</b> .                                     | :DISP:COL{1-2}:BACK  |
| Reset Color       | Displays softkeys for resetting the colors for all items to the factory default.   | :DISP:COL{1-2}:RES   |
| OK                | Resets the color settings for all items to the factory default.  | :DISP:COL{1-2}:RES   |
| Cancel            | Returns to the softkey display screen one level higher.  |                      |
| Return            | Returns to the softkey display screen one level higher.  |                      |
| Invert            | Displays softkeys for setting up the color of the inverted display. The lower-level softkeys are the same as those for <b>Normal</b> .                                     |                      |
| Return            | Returns to the softkey display screen one level higher.  |                      |
| Preset Setup      | Displays the softkeys to execute the preset function.  |                      |
| State             | Displays the softkeys to set the type of preset to be executed.  |                      |
| Factory           | Executes the preset function to recall the factory state.  |                      |
| User              | Executes the preset function to recall a user-specified state.   |                      |
| Confirm           | Toggles on/off whether to display the softkeys for confirmation at the execution of the preset function.   |                      |
| Control Panel...  | Opens a control panel window.  | None                 |
| Return            | Returns to the softkey display screen one level higher.  |                      |
| Backlight         | Turns the backlight for the LCD screen on/off.   | :SYST:BACK           |
| Firmware Revision | Displays the firmware revision information in a dialog box.  | *IDN?                |

## Softkey Functions System Menu

| Key Operation              | Function  | SCPI Command              |
|----------------------------|---|---------------------------|
| <b>System</b>              | (Continued)   |                           |
| <b>Service Menu</b>        | Displays softkeys for maintenance services.   |                           |
| <b>Test Menu</b>           | Displays softkeys for self diagnosis functions.   |                           |
| <b>Power On Test</b>       | Executes an internal test.  | None                      |
| <b>Display</b>             | Executes a display test.  | None                      |
| <b>Front Panel</b>         | Tests the front panel keys (hardkeys).  | None                      |
| <b>Adjust Touch Screen</b> | Executes calibration of the touch screen.   | None                      |
| <b>Return</b>              | Returns to the softkey display screen one level higher.                                       |                           |
| <b>Security Level</b>      | Displays softkeys for the security level function.  |                           |
| <b>None</b>                | Selects security level set to None.   | <b>:SYST:SEC:LEV NON</b>  |
| <b>Low</b>                 | Selects security level set to Low.  | <b>:SYST:SEC:LEV LOW</b>  |
| <b>High</b>                | Selects security level set to High.   | <b>:SYST:SEC:LEV HIGH</b> |
| <b>Cancel</b>              | Returns to the softkey display screen one level higher.                                       |                           |
| <b>Enable Options</b>      | Displays softkeys for other options.  |                           |
| <b>Restart Firmware</b>    | Restarts the firmware of the analyzer.  |                           |
| <b>Service Functions</b>   | Displays softkeys for performing service functions. This option is not open to average users. |                           |
| <b>Return</b>              | Returns to the softkey display screen one level higher.                                       |                           |
| <b>Return</b>              | Returns to the "E5061A/E5062A Menu (Top Menu)" on page 322.                                   |                           |

## Trigger Menu

| Key Operation                   | Function   | SCPI Command    |
|---------------------------------|--|-----------------|
| <b>Trigger</b>                  | Displays following seven softkeys for setting the trigger. Once the trigger mode is set, measurements are executed according to the trigger mode even when the channel is no longer on display due to reduction of the number of channels to be displayed from the “Display Menu” on page 331. |                 |
| <b>Hold</b>                     | Sets the active channel trigger mode to “hold”. A trigger sent from the trigger source to that channel will not prompt a sweep.  | :INIT{1-4}:CONT |
| <b>Single</b>                   | Sets the active channel trigger mode to “single”. A trigger sent from the trigger source to that channel prompts a single sweep and then the sweep mode changes to “hold.”   | :INIT{1-4}      |
| <b>Continuous</b>               | Sets the active channel trigger mode to “continuous”. Each trigger sent from the trigger source to that channel prompts a single sweep.  | :INIT{1-4}:CONT |
| <b>Hold All Channels</b>        | Sets all channel trigger modes to “hold”.  | None            |
| <b>Continuous Disp Channels</b> | Sets all displayed channel trigger modes to “continuous”. See “Setting channel display (layout of channel windows)” on page 49 for details about displayed channels.   | None            |
| <b>Trigger Source</b>           | Displays softkeys for selecting the trigger source.  |                 |
| <b>Internal</b>                 | Selects the “internal” trigger source of the analyzer. The analyzer will generate a series of trigger signals. A trigger, once generated, is sent to all channels in order no matter how many channels are displayed.  | :TRIG:SOUR INT  |
| <b>External</b>                 | Selects the “external” trigger source. A signal input to the external trigger input terminal (BNC(f) connector) on the rear panel will be used as the trigger source. A trigger, once generated, is sent to all channels in order no matter how many channels are displayed.                   | :TRIG:SOUR EXT  |
| <b>Manual</b>                   | Sets the trigger source to “manual”. Pressing the <b>Trigger</b> key in the Trigger Menu generates a trigger. A trigger, once generated, is sent to all channels in order no matter how many channels are displayed.   | :TRIG:SOUR MAN  |
| <b>Bus</b>                      | Sets the analyzer trigger source to “bus”. A trigger is generated by sending a trigger command through the GPIB or a LAN. A trigger, once generated, is sent to all channels in order no matter how many channels are displayed.   | :TRIG:SOUR BUS  |
| <b>Cancel</b>                   | Returns to the softkey display screen one level higher.  |                 |
| <b>Restart</b>                  | Aborts a sweep.  | :ABOR           |
| <b>Trigger</b>                  | When the trigger source is set to “manual”, generates a trigger.   |                 |
| <b>Return</b>                   | Returns to the “E5061A/E5062A Menu (Top Menu)” on page 322.  |                 |

Softkey Functions  
**Trigger Menu**

---

## **E**      **General Principles of Operation**

This chapter explains the general principles of operation for the Agilent E5061A/E5062A.

## System Description

A network analyzer supplies a sweep signal to a DUT, measures its transmission and reflection, and displays the results as ratios against the input signal from the signal source. The E5061A/E5062A network analyzer consists of the circuit modules shown in Figure E-1.

**Figure E-1** System Diagram for the E5061A/E5062A Network Analyzer

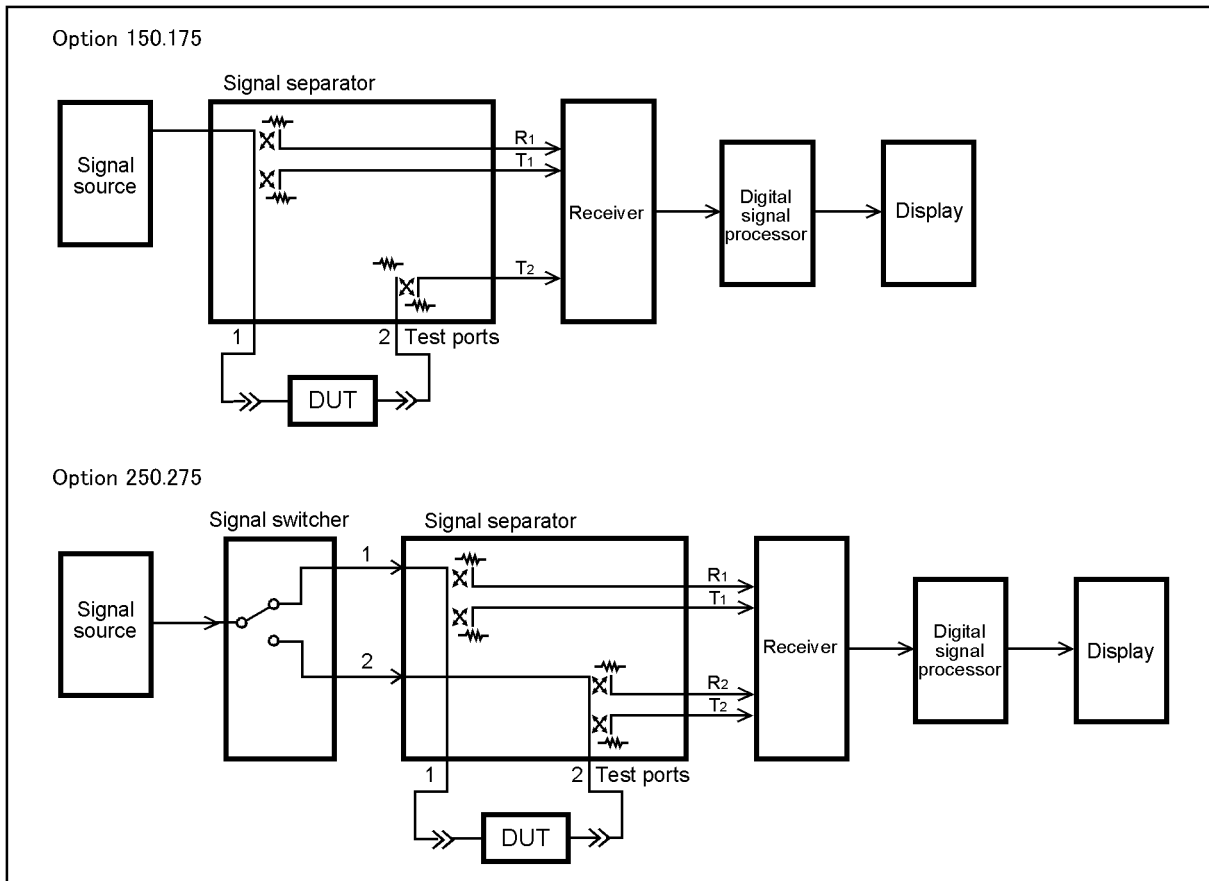

e5061aue018

## Synthesized Source

The synthesized source generates an RF sweep signal in the following frequency range.

- E5061A: 300 kHz ~ 1.5GHz
- E5062A: 300 kHz ~ 3 GHz

The signal source is phase-locked to a highly reliable quartz crystal oscillator to maintain a high level of accuracy in its frequency as well as to achieve precise phase measurements. The level of RF output power is controlled within the range of  $-5$  dBm ~  $+10$  dBm. The E5061A/E5062A with option 250, 275 or 1E1 comes with a source-stepping attenuator which allows the user to set the power level in the range of  $-45$  dBm ~  $+10$  dBm.

## Source Switcher

The source switcher is used to switch test ports to which the RF signal is supplied from the source.

## Signal Separator

The signal separator consists of directivity couplers that detect input and output signals at the test ports. On a test port to which a signal is output, the output signal and the reflection from the DUT are detected as the reference signal (R) and the test signal (T), respectively. On the other ports, the signal that is transmitted through the DUT is detected as the test signal (T). All signals are then sent to the receiver.

## Receiver

Each signal that is sent to the receiver is first converted into an IF signal by a mixer and then converted into a digital signal by an ADC (analog to digital converter). These processes are applied to each signal independently. The digital data is then analyzed by a micro processor and measurement results will be displayed on the screen.

## Data Processing

The internal data processing flowchart for the E5061A/E5062A is shown in Figure E-2.

Figure E-2 Data Processing Flowchart

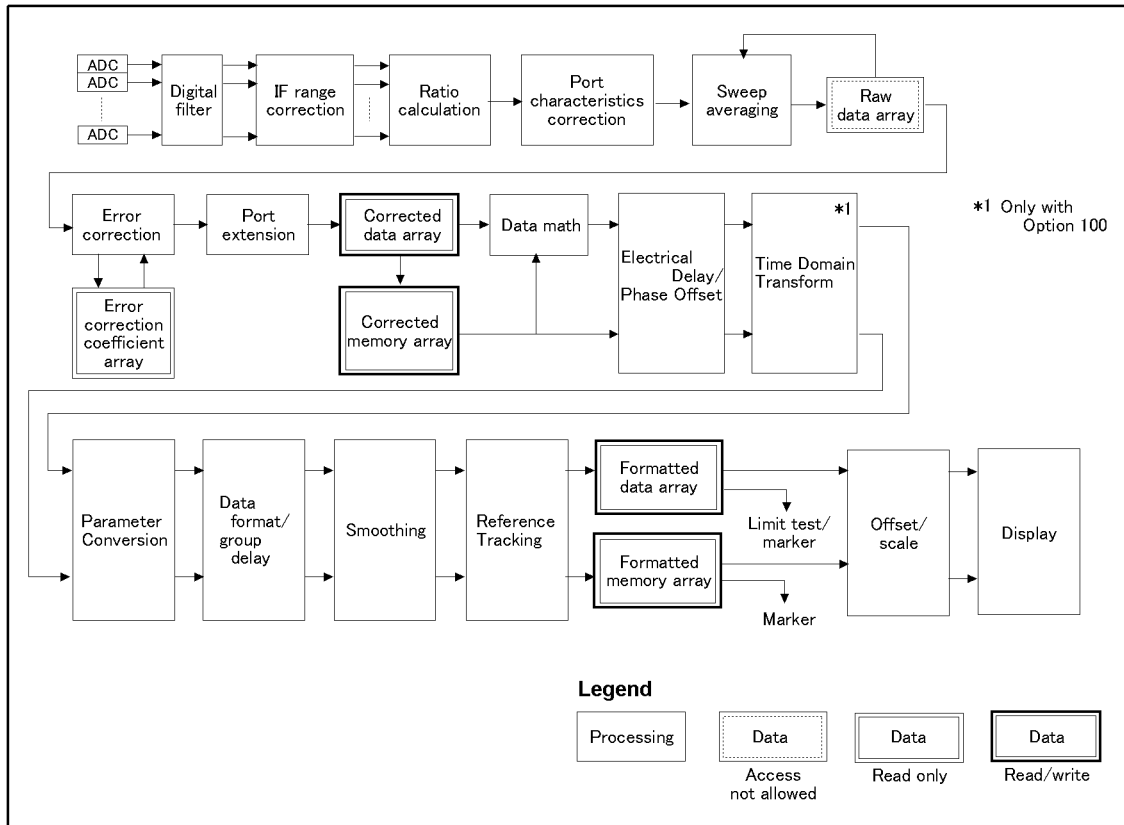

e5061aue2002

### ADC

The ADCs (analog-to-digital converters) convert analog signals fed to the receiver and converted into IF signals ( $R_1$ ,  $R_2$  and  $T_1$ ,  $T_2$ ) into digital signals. One ADC is available for each signal and the conversion takes place simultaneously.

### Digital Filter

The digital filter performs a discrete Fourier transformation (DFT) and picks up IF signals. Each IF signal is then converted into a complex number that has a real part and an imaginary part. The IF bandwidth of the analyzer is equivalent to the bandwidth of the DFT filter. The IF bandwidth can be set in the range of 10 Hz ~ 30 kHz.



## IF Range Correction

Input signals that went through ranging at the receiver are reverted (corrected) to previous values before the ranging.

## Ratio Calculation

The ratio between two signals is determined by performing divisions on complex numbers.

## Port Characteristics Correction

The equivalent source match error, the directivity error, and the tracking error of each test port bridge are corrected.

## Sweep Averaging

The average of complex indices is determined based on data obtained from multiple sweep measurements. Sweep averaging is effective in reducing random noise in measurements.

## Raw Data Array

The results from all data processing done up to this point are stored in this array as raw data. All prior data processing is performed as each sweep takes place. When the full 2-port error correction is enabled, all 4 S parameters are stored in the raw data array and used in error correction. The user is not allowed to access (read/write) this raw data array.

## Error Correction/Error Correction Coefficient Array

When error correction is enabled, the process eliminates the system errors that are reproducible and stored in the error correction coefficient array (calibration coefficient array). It accommodates everything from the simple vector normalization to the full 12-term error correction. The user can read this error correction coefficient array.

## Port Extension

This process carries out a simulation of adding or eliminating a variable length no-loss transmission path on each test port so that the reference plane of calibration is moved. The port extension is defined by an electrical delay (sec).

## Corrected Data Array

Unlike the raw data array, this array stores the results obtained after error corrections, port extensions, or the fixture simulator functions are applied. The user is allowed to read/write data from/to the corrected data array.

## Corrected Memory Array

By pressing **Display** - Data → Mem, the contents of the corrected data array will be copied to this array. The user is allowed to read/write data from/to the corrected memory array.

## Data Math

Data processing is carried out using the corrected data array and the corrected memory array. Four types of data processing – addition, subtraction, multiplication, and division – are available.

## Electrical Delay/Phase Offset

An electrical delay and a phase offset are applied to each trace. By setting an electrical delay, a linear phase that is proportional to the frequency will be added or subtracted. On the other hand, setting a phase offset adds or subtracts a phase that is constant throughout the frequency range. Incidentally, data processing performed from this point on in the flowchart is applied to both the data array and the memory array.

## Data Format/Group Delay

Complex data consisting of the real parts and the imaginary parts are converted into scalar data according to the data format of user's choice. Group delays are also calculated here.

## Smoothing

By enabling the smoothing function, each point in a sweep measurement will be replaced by a moving average of several measurement points nearby. The number of points used in calculating a moving average is determined by the smoothing aperture set by the user. The smoothing aperture is defined by a percentage against the sweep span.

## Reference tracking

When the reference tracking function is turned on, the point to be tracked (peak or specified frequency) is always set as the reference value. Calculation is performed to offset measurement values.

## Formatted Data Array/Formatted Memory Array

All results from data processing are stored in the formatted data array and the formatted memory array. The marker functions are applied to these arrays. The limit test is applied to the formatted data array. The user is allowed to read/write data from/to these arrays.

## Offset/Scale

Each set of data is processed so that traces can be drawn on the screen. Particular scaling depending on the data format is applied using the position of the reference line, the value of the reference line, and the scale/graticule settings.

## Display

The results obtained after data processing are displayed on the screen as traces.

**Symbols**

- .bmp
  - Saving the screen image, 171
- .csv
  - Saving/Recalling files, 167
- CSV file
  - Saving trace data, 167
- .sta
  - Saving/Recalling files, 158

**Numerics**

- 1/S(Trace status), 38
- 1-Port Calibration, 95
  - procedure, 95
  - Using a 2-Port ECal Module, 103

**A**

- ACTIVE CH/TRACE Block, 22
- Active Channel
  - selecting, 53
- Active Trace
  - selecting, 53
- ADC
  - Data Processing, 362
- Admittance, 155
- Allocate traces, 52
- Analysis Menu
  - Softkey Functions, 323
- Analyzer Environment
  - specification, 275
- assistance, 5
- attenuation, 152
- Auto Recall function
  - Settings, 161
- Auto Scale
  - settings, 70
- Automatic Sweep Time Mode
  - switching, 64
- Available printers, 174
- Average Menu
  - Softkey Functions, 324
- Averaging
  - Sweep-to-sweep
    - Equation, 193

**B**

- Bandwidth Search, 146
- Beeper
  - setting, 231
- Bitmap file
  - Screen image, 171

**C**

- Calibration
  - Types and Characteristics, 85

- Calibration kit
  - Changing the calibration kit definition, 107
  - Selecting calibration kit, 88
- Calibration Menu
  - Softkey Functions, 325
- Calibration property, 87
- Capture, 175
- certification, 5
- Channel Window, 36
- Channel window
  - layout, 49
- Characteristic impedance, 56
- Checking calibration status, 86
- Cleaning, 287
- Clipboard, 175
- Color, 77
- Compatibility of files, 158
- Connector Repeatability Errors, 80
- Connectors
  - Maintenance, 287
- Conversion, 155
- Corrected Data Array
  - Data Processing, 363
- Corrected Memory Array
  - Data Processing, 363
- Corrected System Performance
  - specification, 261
- CSV file
  - Limit table, 185

**D**

- D\*M(Trace status), 38
- D+M(Trace status), 38
- D/M(Trace status), 38
- Data Entry Bar, 30
- Data Format
  - Data Processing, 364
  - selecting, 69
- Data Math
  - Data Processing, 364
  - Performing, 153
- Data Transfer Time
  - specification, 278
- Date and Time
  - Display ON/OFF, 216
  - setting, 215
- Default Values, 313
- Definition
  - Calibration kit, 107
- Del(Trace status), 38
- Deviation from a Linear Phase
  - Measuring Examples, 255
- Digital Filter
  - Data Processing, 362
- Dimensions
  - specification, 275
- Directivity Errors, 82

Display  
  Data Processing, 364  
Display Menu  
  Softkey Functions, 331  
Display mode, 77  
D-M(Trace status), 38  
documentation map, 7  
Documentation Warranty, 5  
Drift Errors, 80  
Dynamic Range  
  Expanding, 192

**E**

ECal, 103  
Electrical Delay  
  Data Processing, 364  
Electrical delay, 197  
Electronic Calibration, 103  
EMC  
  specification, 272  
Enhanced Response Calibration, 97  
  procedure, 98  
  Using the 2-Port ECal Module, 104  
ENTRY Block, 26  
Error Correction  
  Data Processing, 363  
Error Correction Coefficient Array  
  Data Processing, 363  
Error correction status, 86  
Error Messages, 301  
Ethernet Port, 43  
exclusive remedies, 5  
Executing print, 176  
Ext Trig, 44  
External Monitor Output Terminal, 43  
External PC  
  Connecting via LAN, 227  
External Reference Signal Input Connector, 44  
External Trigger Input Connector, 44

**F**

F1(Trace status), 38  
F2(Trace status), 38  
Fail Sign, 181  
Fan, 43  
File  
  Copy, 162  
  Delete, 162  
  Rename a file, 162  
Firmware Revision  
  Checking, 233  
  Manual Changes, 292  
Floppy Disk Drive, 24  
Format Menu  
  Softkey Functions, 334  
Formatted Data Array  
  Data Processing, 364

Formatted Memory Array  
  Data Processing, 364  
Frequency Base Display, 203  
Frequency Range  
  settings, 57  
Front Keys  
  Locking, 230  
front panel, 20  
Front Panel Information  
  specification, 272  
Full 2-Port Calibration, 100  
  procedure, 101  
  Using the 2-Port ECal Module, 105

**G**

gain, 151  
Gat(Trace status), 38  
General Information  
  specification, 271  
GPIB  
  setting, 212  
GPIB Connector, 44  
Graph layout, 52  
Graticule Labels  
  turning off the display, 73  
Group Delay  
  Data Processing, 364

**H**

Handler I/O Port, 44  
Hiding Frequency Information, 75  
Hiding Softkey's Frequency Information, 75  
history,  
  manual printing, 2  
HP DeskJet 5650 Series, 174

**I**

IF Range Correction  
  Data Processing, 363  
Impedance, 155  
Initializing, 48  
Input from the front panel, 162  
Installation and Quick Start Guide, 7  
INSTR STATE Block, 27  
Instrument Noise Errors, 80  
Instrument Status Bar, 34  
Internal Clock  
  setting, 215  
Internal Data  
  Saving and Recalling, 158  
Internal Reference Signal Output Connector, 44  
Invert color, 77  
Isolation errors, 82

**K**

Keyboard

- 
- Locking, 230
  - Keyboard Port, 45
  - L**
  - Layout of channel windows, 49
  - LCD Screen, 21
  - LCD Screen Backlight
    - Turning off, 232
  - Limit Line
    - Defining, 182
  - Limit test
    - Clip, 186
    - Concept, 180
    - Displaying judgement result, 181
    - Limit line
      - ON/OFF, 187
    - Limit table
      - Adding/Deleting segments, 182
      - Begin Response, 183
      - Begin Stimulus, 183
      - Call, 182
      - Clear, 182
      - Creating/Editing, 182
      - End Response, 183
      - End Stimulus, 183
      - Initializing, 187
      - MAX/MIN/OFF, 183
      - Save to a file, 182
      - Type, 183
      - ON/OFF, 187
  - Line Switch, 43
  - Load match errors, 83
  - M**
  - M(Trace status), 38
  - Macro Setup Menu
    - Softkey Functions, 335
  - manual changes, 291
  - manual printing history, 2
  - Manual Sweep Time Mode
    - settings, 64
  - Marker
    - Listing All the Marker Values, 131
    - Reading Only the Actual Measurement Point, 129
    - Reading the Relative Value, 128
    - Reading the Value Interpolated Between Measurement Points, 129
    - Reading Values on the Trace, 125
    - Search for the maximum, 137
    - Search for the minimum, 137
    - Search for the Target Value, 138
    - Search Tracking, 136
    - Searching for the Peak, 142
    - Setting Up Markers for Coupled Operations Between Traces, 130
    - Setting Up Markers for Each Trace, 130
  - marker
    - flatness, 151
    - Marker Function Menu
      - Softkey Functions, 339
    - Marker Menu
      - Softkey Functions, 337
    - Marker Response Value
      - setting up, 125
    - Marker Search Menu
      - Softkey Functions, 340
    - Maximum search, 137
    - Measurement capabilities
      - specification, 279
    - Measurement Menu
      - Softkey Functions, 344
    - Measurement Parameters
      - selecting, 65
    - Measurement Throughput
      - Improving, 200
    - Measurement Throughput Summary
      - specification, 277
    - Menu Bar, 30
    - Minimum search, 137
    - MKR/ANALYSIS Block, 28
    - Mouse
      - Locking, 230
      - Setup Step, 217
    - Mouse Port, 45
    - multi
      - peak search, 144
      - target search, 140
  - N**
  - NAVIGATION Block, 25
  - Network
    - Configuring, 220
  - Nominal
    - Definitions, 260
  - Number of channels, 49
  - Number of Points
    - settings, 63
  - O**
  - Offset
    - Data Processing, 364
  - Open dialog box, 163
  - OPEN/SHORT Response Calibration, 89
    - procedure, 89
  - Operational Manual, 7
  - Order Base Display, 203
  - P**
  - Parallel port, 174
  - Parameter conversion, 155
  - Peak search, 142
  - Phase Measurements
    - Improving the Accuracy, 197

- Phase Offset
    - Data Processing, 364
  - Phase offset, 199
  - Polar Format, 67
    - manual scale adjustment, 72
  - Port Characteristics Correction
    - Data Processing, 363
  - Port Extension
    - Data Processing, 363
  - Port extension, 198
  - Power Cable Receptacle, 43
  - Power Level
    - settings, 61
  - preset
    - confirmation button, 234
    - preset function, 234
  - Preset Menu
    - Softkey Functions, 345
  - Printer
    - Available printers, 174
  - Printer driver
    - install, 177
  - Printer Parallel Port, 43
  - Printer parallel port, 174
  - Printers Folder dialog box, 176
  - Programming Manual, 7
- Q**
- Quick Start Guide, 7
- R**
- Random Errors, 80
  - Ratio Calculation
    - Data Processing, 363
  - Raw Data Array
    - Data Processing, 363
  - Rear Panel, 42
  - Rear Panel Information
    - specification, 272
  - Recalling a file
    - Compatibility, 158
  - Receiver
    - System Description, 361
  - Rectangular Display Format
    - manual scale adjustment, 70
  - Rectangular Display Formats, 66
  - Ref In, 44
  - Ref Out, 44
  - Reference Line
    - settings, 72
  - Reference Tracking, 188
  - Reflection Test, 89, 95
    - procedure, 89, 95
  - Reflection tracking errors, 83
  - Relative Limit, 188
  - Remote Control, 225
  - Replacement of Parts, 288
  - Reserved Port, 45
  - RESPONSE Block, 23
  - RF filter
    - loss, 152
  - ripple, 152
  - RO(Trace status), 38
  - RS(Trace status), 38
  - RT(Trace status), 38
- S**
- Safe mode, 21
  - Safety
    - specification, 272
  - safety
    - symbols, 4
  - safety summary, 3
  - Sample Program, 8
  - Save as dialog box, 162
  - Save/Recall Menu
    - Softkey Functions, 346
  - SaveToTouchstone.vba, 168
  - Saving a file
    - Compatibility, 158
  - Saving a user preset, 235
  - Saving/Recalling files
    - All, 158
    - State & Cal, 158
    - State & Trace, 158
    - State Only, 158
  - SAW Bandpass Filter
    - Measuring Examples, 248
  - Scale
    - Data Processing, 364
  - Scale Menu
    - Softkey Functions, 349
  - Scales
    - settings, 70
  - Screen Area, 30
  - Screen Image
    - output, 174
    - Saving to a File, 171
  - Search Tracking, 136
  - section titles, 288, 360
  - Segment Display
    - Setting Up, 208
  - Segment Sweep
    - Concept, 201
    - Executing, 208
  - Segment Table
    - Creating, 205
    - Saving in CSV Format, 209
  - Serial Number
    - Checking, 233
    - Manual Changes, 292
  - Serial Number Plate, 45
  - Serial number plate, 292
  - Setting the user preset, 234

- 
- Signal Separator
    - System Description, 361
  - Simplified full 3/4 port calibration, 86
  - slope, 151
  - Smith Chart
    - manual scale adjustment, 72
  - Smith Chart Format, 68
  - Smo(Trace status), 38
  - Smoothing
    - Data Processing, 364
  - Softkey Menu Bar, 32
  - Source match errors, 83
  - Source Switcher
    - System Description, 361
  - span, 151
  - S-Parameters
    - settings, 65
  - Specification
    - Definitions, 260
  - Specifications, 259
  - Standby Switch, 21
  - Stimulus
    - settings, 57
  - STIMULUS Block, 24
  - Stimulus Menu
    - Softkey Functions, 350
  - Supported printers, 174
  - Sweep Averaging
    - Data Processing, 363
  - Sweep Delay Time
    - Segment Sweep, 203
  - Sweep Setup Menu
    - Softkey Functions, 351
  - Sweep Time
    - Segment Sweep, 203
    - settings, 63
  - Sweep-to-sweep averaging
    - Equation, 193
  - Switch Repeatability Errors, 80
  - Synthesized Source
    - System Description, 360
  - System Bandwidths
    - specification, 271
  - System Description, 360
  - System Dynamic Range
    - specification, 261
  - System Menu
    - Softkey Functions, 353
  - System Recovery
    - How to Execute, 236
  - System Z0, 56
  - Systematic Errors, 81
- T**
- Target search, 138
  - Test Port, 28
  - Test Port Input (Dynamic Accuracy)
    - specification, 269
  - Test Port Input (Group Delay)
    - specification, 270
  - Test Port Input (Stability)
    - specification, 269
  - Test Port Input (Trace Noise)
    - specification, 268
  - Test Port Input Levels
    - specification, 268
  - Test Port Output Frequency
    - specification, 267
  - Test Port Output Power
    - specification, 267
  - Test Port Output Signal Purity
    - specification, 267
  - Test Ports
    - Maintenance, 287
  - THRU Response Calibration, 92
    - procedure, 92
  - Touch Screen
    - Calibration, 246
  - Touchstone
    - Saving/Recalling files, 168
  - Trace
    - Comparing, 153
    - Determining the Bandwidth, 146
    - Determining the Mean, Standard Deviation, and p-p, 150
  - Trace Data
    - Saving, 167
  - Trace Display
    - maximizing, 73
  - Trace layout, 51
  - Trace Noise
    - Reducing, 195
  - Trace Status Area, 38
  - Trace status area
    - Status of the error correction for each trace, 86
  - Transmission Test, 92
    - procedure, 92
  - Transmission tracking errors, 84
  - Trigger
    - setting, 120
  - Trigger Menu
    - Softkey Functions, 357
  - Trigger Modes
    - function, 121
  - Trigger Source
    - function, 121
  - Troubleshooting
    - during Operation, 297
    - during Startup, 296
    - External Devices, 300
  - typeface conventions, 6
  - Typical
    - Definitions, 260
  - Typical Cycle Time for Measurement Completion
    - specification, 277

---

## U

Uncorrected System Performance  
  specification, 266  
Update Off, 200  
USB Port, 29, 45  
USB port, 174

## V

Velocity factor, 199  
Video, 43  
Virtual Network Computing, 225  
VNC, 225

## W

Warning Message, 310  
Web Server, 225  
Window  
  labeling, 76  
Window Display  
  maximizing, 73  
Window Displays  
  settings, 73

## Y

Yr(Trace status), 38  
Yt(Trace status), 38

## Z

Z0, 56  
Zr(Trace status), 38  
Zt(Trace status), 38